



PowerShot N

Camera User Guide

ENGLISH

- Before use, be sure to read this guide, including the safety precautions.
- Reading this guide will help you learn to use the camera properly.
- Store this guide safely so that you can use it in the future.
- Click the buttons in the lower right to access other pages.
 - : Next page
 - : Previous page
 - : Page before you clicked a link
- To jump to the beginning of a chapter, click the chapter title at right.
From chapter title pages, you can access topics by clicking their titles.

| |
|---|
| Cover |
| Preliminary Notes and Legal Information |
| Contents: Basic Operations |
| Basic Guide |
| Advanced Guide |
| 1 Camera Basics |
| 2 Creative Shot Mode |
| 3 Auto Mode/Hybrid Auto Mode |
| 4 Other Shooting Modes |
| 5 P Mode |
| 6 Playback Mode |
| 7 Wi-Fi Functions |
| 8 Setting Menu |
| 9 Accessories |
| 10 Appendix |
| Index |



Package Contents

Before use, make sure the following items are included in the package. If anything is missing, contact your camera retailer.



Camera



Battery Pack
NB-9L

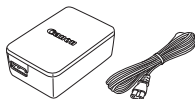

Compact Power Adapter
CA-DC30/CA-DC30E

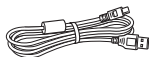

Interface Cable
IFC-400PCU

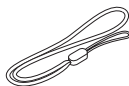

Wrist Strap
WS-800



DIGITAL CAMERA
Solution Disk*
(CD-ROM)



Getting Started



Warranty System Booklet

* Contains software (📖19).

• A memory card is not included (📖2).

Compatible Memory Cards

The following memory cards (sold separately) can be used, regardless of capacity.

- microSD memory cards*
- microSDHC memory cards*
- microSDXC memory cards* 

* Cards conforming to SD standards. However, not all memory cards have been verified to work with the camera.

Preliminary Notes and Legal Information

- Take and review some test shots initially to make sure the images were recorded correctly. Please note that Canon Inc., its subsidiaries and affiliates, and its distributors are not liable for any consequential damages arising from any malfunction of a camera or accessory, including memory cards, that result in the failure of an image to be recorded or to be recorded in a way that is machine readable.
- Images recorded by the camera are intended for personal use. Refrain from unauthorized recording that infringes on copyright law, and note that even for personal use, photography may contravene copyright or other legal rights at some performances or exhibitions, or in some commercial settings.
- For information on your camera's warranty, please refer to the warranty information provided with your camera. For Canon Customer Support, please refer to the warranty information for contact information.
- Although the LCD monitor is produced under extremely high-precision manufacturing conditions and more than 99.99% of the pixels meet design specifications, in rare cases some pixels may be defective or may appear as red or black dots. This does not indicate camera damage or affect recorded images.
- The LCD monitor may be covered with a thin plastic film for protection against scratches during shipment. If covered, remove the film before using the camera.
- When the camera is used over an extended period, it may become warm. This does not indicate damage.

Cover

Preliminary Notes and
Legal Information

Contents: Basic
Operations

Basic Guide

Advanced Guide

1 Camera Basics

2 Creative Shot
Mode

3 Auto Mode/
Hybrid Auto Mode

4 Other Shooting
Modes

5 P Mode

6 Playback Mode

7 Wi-Fi Functions

8 Setting Menu

9 Accessories

10 Appendix

Index



Part Names and Conventions in This Guide

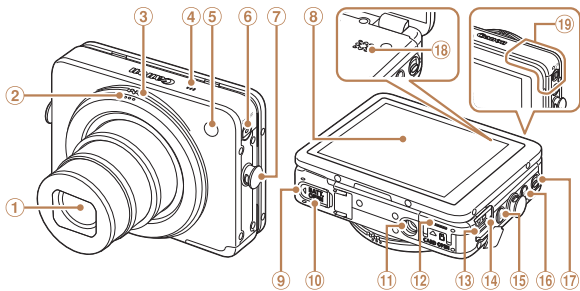

- ① Lens
- ② Shutter ring
- ③ Zoom ring
- ④ Microphone
- ⑤ Flash/Lamp
- ⑥ ON/OFF button/lamp
- ⑦ Strap mount
- ⑧ Screen (LCD monitor)
- ⑨ Battery cover
- ⑩ DC coupler terminal cover

- ⑪ Tripod socket
- ⑫ Memory card cover
- ⑬ DIGITAL terminal
- ⑭ USB charge lamp
- ⑮ <▶ (Playback)> button
- ⑯ <□ (Mobile device connect)> button
- ⑰ Mode switch
- ⑱ Speaker
- ⑲ Wi-Fi antenna area

- In this guide, icons are used to represent the corresponding camera buttons on which they appear, or which they resemble.
- Shooting modes and on-screen icons and text are indicated in brackets.
- ⚠: Important information you should know
- 📝: Notes and tips for expert camera use
- 📖xx: Pages with related information (in this example, “xx” represents a page number)
- Instructions in this guide apply to the camera under default settings.
- For convenience, all supported memory cards are simply referred to as the “memory card”.
- The tabs shown above titles indicate whether the function is used for still images, movies, or both.

Still Images : Indicates that the function is used when shooting or viewing still images.

Movies : Indicates that the function is used when shooting or viewing movies.

Cover

Preliminary Notes and Legal Information

Contents: Basic Operations

Basic Guide

Advanced Guide

1 Camera Basics

2 Creative Shot Mode

3 Auto Mode/ Hybrid Auto Mode

4 Other Shooting Modes

5 P Mode

6 Playback Mode

7 Wi-Fi Functions

8 Setting Menu

9 Accessories

10 Appendix

Index



Table of Contents

| | | | |
|---|---|--|----|
| Package Contents | 2 | 2 Creative Shot Mode.....32 | |
| Compatible Memory Cards | 2 | Shooting (Creative Shot) | 33 |
| Preliminary Notes and Legal Information | 2 | Viewing | 33 |
| Part Names and Conventions in This Guide..... | 3 | 3 Auto Mode/Hybrid Auto Mode.....35 | |
| Table of Contents | 4 | Shooting With Camera-Determined Settings | 36 |
| Contents: Basic Operations | 5 | Common, Convenient Features | 41 |
| Safety Precautions..... | 6 | Using Face ID | 44 |
| | | Image Customization Features..... | 49 |
| | | Helpful Shooting Features | 50 |
| | | Customizing Camera Operation | 51 |
| | | 4 Other Shooting Modes.....53 | |
| | | Applying Special Effects | 54 |
| | | Shooting Super Slow Motion Movies..... | 57 |
| | | 5 P Mode.....59 | |
| | | Shooting in Program AE ([P] Mode)..... | 60 |
| | | Image Brightness (Exposure Compensation) | 60 |
| | | Adjusting White Balance | 61 |
| | | Continuous Shooting | 62 |
| | | Activating Flash..... | 63 |

Basic Guide..... 9

| | |
|-------------------------------|----|
| Touch-Screen Operations | 10 |
| Initial Preparations | 10 |
| Trying the Camera Out | 16 |
| Using the Software | 19 |
| System Map | 24 |

Advanced Guide..... 25

1 Camera Basics.....25

| | |
|--------------------------------|----|
| On/Off | 26 |
| Shutter Ring | 27 |
| Holding the Camera..... | 28 |
| Shooting Display Options | 29 |
| FUNC. Menu | 29 |
| MENU Menu | 30 |
| Indicator Display | 31 |

| | |
|------------------------------------|----|
| Changing the IS Mode Settings..... | 63 |
|------------------------------------|----|

6 Playback Mode64

| | |
|---|----|
| Viewing | 65 |
| Browsing and Filtering Images | 68 |
| Editing Face ID Information | 70 |
| Image Viewing Options | 71 |
| Erasing Images..... | 72 |
| Rotating Images..... | 74 |
| Tagging Images as Favorites | 75 |
| Convenient Control: Touch Actions | 76 |
| Editing Still Images | 77 |
| Editing Movies..... | 78 |

7 Wi-Fi Functions80

| | |
|---|----|
| What You Can Do With Wi-Fi..... | 81 |
| Using Wi-Fi to Send Images From the Camera..... | 82 |
| Wi-Fi (Wireless LAN) Precautions..... | 83 |
| Security Precautions..... | 84 |
| Glossary..... | 84 |
| Connecting to a Smartphone | 85 |
| Accessing the Wi-Fi Menu | 88 |
| Connecting to Web Services..... | 89 |
| Connecting to Another Camera | 91 |
| Connecting to a Computer | 92 |
| Connecting to a Printer | 98 |
| Sending Images..... | 99 |

| | |
|---|-----|
| Sending Images to a Computer via CANON iMAGE GATEWAY..... | 101 |
| Geotagging Images on the Camera | 102 |
| Editing or Erasing Wi-Fi Settings..... | 102 |

8 Setting Menu.....105

| | |
|--|-----|
| Adjusting Basic Camera Functions | 106 |
|--|-----|

9 Accessories111

| | |
|----------------------------------|-----|
| Optional Accessories | 112 |
| Using Optional Accessories | 113 |
| Printing Images | 115 |

10 Appendix.....118

| | |
|---------------------------------|-----|
| Troubleshooting | 119 |
| On-Screen Messages | 122 |
| On-Screen Information | 124 |
| Functions and Menu Tables | 126 |
| Handling Precautions..... | 129 |
| Specifications..... | 129 |
| Index | 132 |

Cover

Preliminary Notes and Legal Information

Contents: Basic Operations

Basic Guide

Advanced Guide

1 Camera Basics

2 Creative Shot Mode

3 Auto Mode/Hybrid Auto Mode

4 Other Shooting Modes

5 P Mode

6 Playback Mode

7 Wi-Fi Functions

8 Setting Menu

9 Accessories

10 Appendix

Index



Contents: Basic Operations

Shoot

- See several effects applied to each shot, using camera-determined settings (Creative Shot Mode) 33



- Shoot from many angles 28

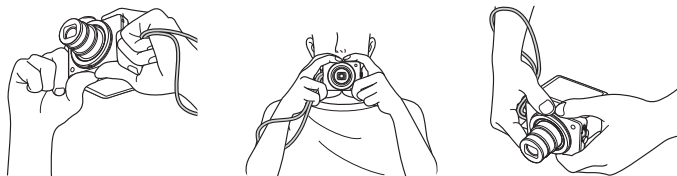

- Applying special effects



Fish-Eye Effect
(44)



Miniature Effect
(45)



Toy Camera Effect
(46)



Soft Focus
(46)



Monochrome
(47)

- Use camera-determined settings (Auto Mode, Hybrid Auto Mode)..... 36, 38
- Adjust functions to suit the situation



Where flash is not allowed
(44)



Using the self-timer
(42)



Using Face ID
(44)

View

- View images (Playback Mode)..... 65
- Browse through images quickly 68
- Erase images 72
- Share images via Wi-Fi 99



Cover

Preliminary Notes and Legal Information

Contents: Basic Operations

Basic Guide

Advanced Guide

1 Camera Basics

2 Creative Shot Mode

3 Auto Mode/Hybrid Auto Mode

4 Other Shooting Modes

5 P Mode

6 Playback Mode

7 Wi-Fi Functions

8 Setting Menu

9 Accessories

10 Appendix

Index



Safety Precautions

- Before using the product, please ensure that you read the safety precautions described below. Always ensure that the product is used correctly.
- The safety precautions noted on the following pages are intended to prevent injuries to yourself and other persons, or damage to the equipment.
- Be sure to also check the guides included with any separately sold accessories you use.



Warning

Denotes the possibility of serious injury or death.

- **Do not trigger the flash in close proximity to people's eyes.**
Exposure to the intense light produced by the flash could damage eyesight. In particular, remain at least 1 meter (39 inches) away from infants when using the flash.
- **Store this equipment out of the reach of children and infants.**
Strap: Putting the strap around a child's neck could result in asphyxiation.
- **Use only recommended power sources.**
- **Do not attempt to disassemble, alter or apply heat to the product.**
- **Avoid dropping or subjecting the product to severe impacts.**
- **To avoid the risk of injury, do not touch the interior of the product if it has been dropped or otherwise damaged.**
- **Stop using the product immediately if it emits smoke, a strange smell, or otherwise behaves abnormally.**
- **Do not use organic solvents such as alcohol, benzene, or thinner to clean the product.**
- **Do not let the product come into contact with water (e.g. sea water) or other liquids.**

- **Do not allow liquids or foreign objects to enter the camera.**

This could result in electrical shock or fire.

If liquids or foreign objects come into contact with the camera interior, immediately turn the camera off and remove the battery.

If the compact power adapter becomes wet, unplug it from the outlet and consult your camera retailer or a Canon Customer Support Help Desk.

- **Use only the recommended battery.**
- **Do not place the battery near or in direct flame.**
- **Unplug the power cord periodically, and using a dry cloth, wipe away any dust and dirt that has collected on the plug, the exterior of the power outlet, and the surrounding area.**
- **Do not handle the power cord with wet hands.**
- **Do not use the equipment in a manner that exceeds the rated capacity of the electrical outlet or wiring accessories. Do not use if the power cord or plug are damaged, or not fully plugged into the outlet.**
- **Do not allow dirt or metal objects (such as pins or keys) to contact the terminals or plug.**

The battery may explode or leak, resulting in electrical shock or fire. This could cause injury and damage the surroundings. In the event that a battery leaks and the battery electrolyte contacts eyes, mouth, skin or clothing, immediately flush with water.

- **Turn the camera off in places where camera use is prohibited.**

The electromagnetic waves emitted by the camera may interfere with the operation of electronic instruments and other devices. Exercise adequate caution when using the camera in places where use of electronic devices is restricted, such as inside airplanes and medical facilities.

- **Do not play the supplied CD-ROM(s) in any CD player that does not support data CD-ROMs.**

It is possible to suffer hearing loss from listening with headphones to the loud sounds of a CD-ROM played on an audio CD player (music player). Additionally, this could damage the speakers.

Cover

Preliminary Notes and
Legal Information

Contents: Basic
Operations

Basic Guide

Advanced Guide

1 Camera Basics

2 Creative Shot
Mode

3 Auto Mode/
Hybrid Auto Mode

4 Other Shooting
Modes

5 P Mode

6 Playback Mode

7 Wi-Fi Functions

8 Setting Menu

9 Accessories

10 Appendix

Index





Caution

Denotes the possibility of injury.

- **When holding the camera by the strap, be careful not to bang it, subject it to strong impacts or shocks, or let it get caught on other objects.**

- **Be careful not to bump or push strongly on the lens.**

This could lead to injury or damage the camera.

- **Be careful not to subject the screen to strong impacts.**

If the screen cracks, injury may result from the broken fragments.

- **When using the flash, be careful not to cover it with your fingers or clothing.**

This could result in burns or damage to the flash.

- **Avoid using, placing or storing the product in the following places:**

- **Places subject to direct sunlight**
- **Places subject to temperatures above 40 °C (104 °F)**
- **Humid or dusty areas**

These could cause leakage, overheating or an explosion of the battery, resulting in electrical shock, fire, burns or other injuries.

High temperatures may cause deformation of the camera or compact power adapter.

Caution

Denotes the possibility of damage to the equipment.

- **Do not aim the camera at bright light sources (such as the sun on a clear day).**

Doing so may damage the image sensor.

- **When using the camera on a beach or at a windy location, be careful not to allow dust or sand to enter the camera.**

This may cause the product to malfunction.

- **In regular use, small amounts of smoke may be emitted from the flash.**

This is due to the high intensity of the flash burning dust and foreign materials stuck to the front of the unit. Please use a cotton swab to remove dirt, dust or other foreign matter from the flash to prevent heat build-up and damage to the unit.

- **Remove and store the battery when you are not using the camera.**

If the battery is left inside the camera, damage caused by leakage may occur.

- **Before you discard the battery, cover the terminals with tape or other insulators.**

Contacting other metal materials may lead to fire or explosions.

- **Unplug the compact power adapter from the power outlet after charging is complete, or when you are not using it.**
- **Do not place anything, such as cloth, on top of the battery charger while it is charging.**

Leaving the unit plugged in for a long period of time may cause it to overheat and distort, resulting in fire.

- **Do not place the battery near pets.**

Pets biting the battery could cause leakage, overheating or explosion, resulting in fire or damage.

Cover

Preliminary Notes and Legal Information

Contents: Basic Operations

Basic Guide

Advanced Guide

1 Camera Basics

2 Creative Shot Mode

3 Auto Mode/Hybrid Auto Mode

4 Other Shooting Modes

5 P Mode

6 Playback Mode

7 Wi-Fi Functions

8 Setting Menu

9 Accessories

10 Appendix

Index



- **Keep credit cards or other objects affected by magnetism away from the screen.**

The magnet on the back of the screen may cause data loss.

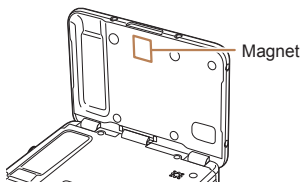

-
- **Do not sit down with the camera in your pocket.**

Doing so may cause malfunctions or damage the screen.

-
- **When putting the camera in your bag, ensure that hard objects do not come into contact with the screen.**

- **Do not attach any hard objects to the camera.**

Doing so may cause malfunctions or damage the screen.



Cover

Preliminary Notes and
Legal Information

Contents: Basic
Operations

Basic Guide

Advanced Guide

1 Camera Basics

2 Creative Shot
Mode

3 Auto Mode/
Hybrid Auto Mode

4 Other Shooting
Modes

5 P Mode

6 Playback Mode

7 Wi-Fi Functions

8 Setting Menu

9 Accessories

10 Appendix

Index



Basic Guide

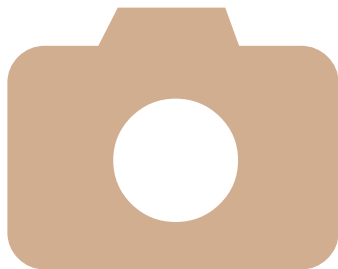

Gives basic instructions, from initial preparations to shooting, playback, and saving on a computer

| | |
|-------------------------------|----|
| Touch-Screen Operations | 10 |
| Initial Preparations | 10 |
| Trying the Camera Out..... | 16 |
| Using the Software..... | 19 |
| System Map | 24 |

Cover

Preliminary Notes and
Legal Information

Contents: Basic
Operations

Basic Guide

Advanced Guide

1 Camera Basics

2 Creative Shot
Mode

3 Auto Mode/
Hybrid Auto Mode

4 Other Shooting
Modes

5 P Mode

6 Playback Mode

7 Wi-Fi Functions

8 Setting Menu

9 Accessories

10 Appendix

Index



Touch-Screen Operations

The camera's touch-screen panel enables intuitive operation simply by touching or tapping the screen.

Touch



Touch the screen briefly with your finger.

- This gesture is used to shoot, configure camera functions, and so on.

Drag

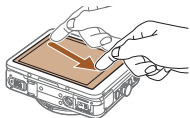

Touch the screen and move your finger across it.

- This gesture is used in Playback mode to switch to the next image, or to change the magnified image area, among other operations.

Initial Preparations

Prepare for shooting as follows.

Attaching the Strap

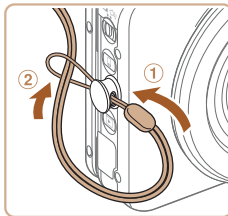

- Thread the end of the strap through the strap hole (①), and then pull the other end of the strap through the loop on the threaded end (②).

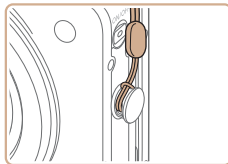

- The strap can also be attached to the left side of the camera.

Cover

Preliminary Notes and
Legal Information

Contents: Basic
Operations

Basic Guide

Advanced Guide

1 Camera Basics

2 Creative Shot
Mode

3 Auto Mode/
Hybrid Auto Mode

4 Other Shooting
Modes

5 P Mode

6 Playback Mode

7 Wi-Fi Functions

8 Setting Menu

9 Accessories

10 Appendix

Index



Inserting and Charging the Battery

Insert the included battery into the camera for charging. Be sure to charge the battery initially, because the camera is not sold with the battery charged.

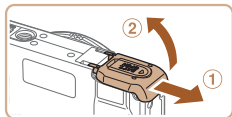

1 Open the cover.

- Slide the cover (①) and open it (②).

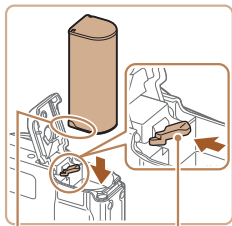

Terminals Battery Lock

2 Insert the battery.

- While pressing the battery lock in the direction of the arrow, insert the battery as shown and push it in until it clicks into the locked position.
- If you insert the battery facing the wrong way, it cannot be locked into the correct position. Always confirm that the battery is facing the right way and locks when inserted.



3 Close the cover.

- Lower the cover (①) and hold it down as you slide it, until it clicks into the closed position (②).

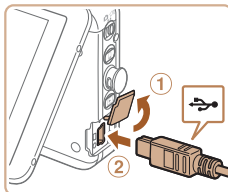

4 Connect the compact power adapter to the camera.

- With the camera turned off, open the cover (①). With the smaller plug of the included interface cable (②) in the orientation shown, insert the plug fully into the camera terminal (②).

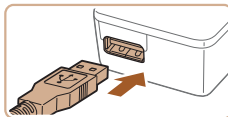

- Insert the larger plug of the interface cable into the included compact power adapter.

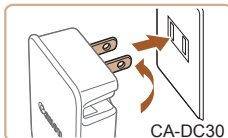

5 Charge the battery.

- **CA-DC30:** Flip out the plug and plug the compact power adapter into a power outlet.
- **CA-DC30E:** Plug the power cord into the compact power adapter, and then plug the other end into a power outlet.

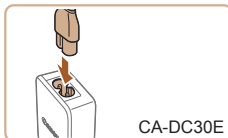

Cover

Preliminary Notes and
Legal Information

Contents: Basic
Operations

Basic Guide

Advanced Guide

1 Camera Basics

2 Creative Shot
Mode

3 Auto Mode/
Hybrid Auto Mode

4 Other Shooting
Modes

5 P Mode

6 Playback Mode

7 Wi-Fi Functions

8 Setting Menu

9 Accessories

10 Appendix

Index



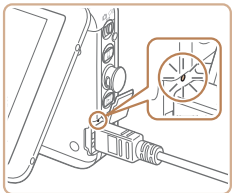

- ▶ Charging begins and the USB charge lamp lights up.
- ▶ The lamp turns off when charging finishes.
- Remove the compact power adapter from the power outlet and the interface cable from the camera.



- To protect the battery and keep it in optimal condition, do not charge it continuously for more than 24 hours.
- For compact power adapters that use a power cord, do not attach the adapter or cord to other objects. Doing so could result in malfunction or damage to the product.



- For details on charging time and the number of shots and recording time possible with a fully charged battery, see “Number of Shots/Recording Time, Playback Time” (130).
- You can view images even while the battery is charging, by turning the camera on and entering Playback mode (65). However, you cannot shoot while the battery is charging. Also note that the camera cannot be used unless the battery is in it.
- Charged batteries gradually lose their charge, even when they are not used. Charge the battery on (or immediately before) the day of use.
- The compact power adapter can be used in areas with 100 – 240 V AC power (50/60 Hz). For power outlets in a different format, use a commercially available adapter for the plug. Never use an electrical transformer designed for traveling, which may damage the battery.

■ Using a Computer to Charge the Battery

You can also charge the battery by inserting the larger plug of the interface cable into a computer's USB terminal in step 4 of “Inserting and Charging the Battery” (11). For details about USB connections on the computer, refer to the computer user manual.

■ Removing the Battery



- Open the cover and press the battery lock in the direction of the arrow.
- ▶ The battery will pop up.

Cover

Preliminary Notes and Legal Information

Contents: Basic Operations

Basic Guide

Advanced Guide

1 Camera Basics

2 Creative Shot Mode

3 Auto Mode/ Hybrid Auto Mode

4 Other Shooting Modes

5 P Mode

6 Playback Mode

7 Wi-Fi Functions

8 Setting Menu

9 Accessories

10 Appendix

Index



Inserting the Memory Card

Insert a memory card (sold separately).

Note that before using a new memory card (or a memory card formatted in another device), you should format the memory card with this camera (📖108).

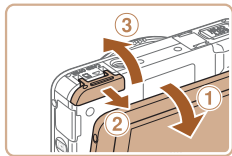

1 Open the cover.

- After opening the screen (①), slide the cover open (②) and up (③).

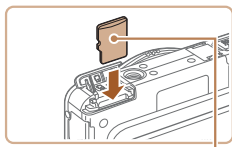

Label

2 Insert the memory card.

- Insert the memory card facing as shown until it clicks into the locked position.
- Make sure the memory card is facing the right way when you insert it. Inserting memory cards facing the wrong way may damage the camera.

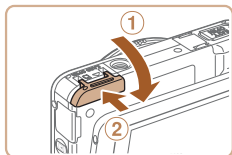

3 Close the cover.

- Lower the cover (①) and hold it down as you slide it, until it clicks into the closed position (②).



- For guidelines on how many shots or hours of recording can be saved on one memory card, see "Number of 4:3 Shots per Memory Card" (📖130).

Removing the Memory Card

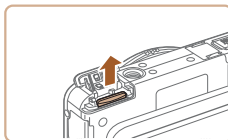

- Open the cover and push the memory card in until it clicks, and then slowly release the memory card.
- ▶ The memory card will pop up.

Setting the Date and Time

Set the current date and time correctly as follows if the [Date/Time] screen is displayed when you turn the camera on. Information you specify this way is recorded in image properties when you shoot, and it is used when you manage images by shooting date or print images showing the date.



1 Turn the camera on.

- Press the ON/OFF button.
- ▶ The [Date/Time] screen is displayed.

2 Set the date and time.

- Touch the option to configure, and then touch [▲][▼] to specify the date and time.
- Touch [Next].

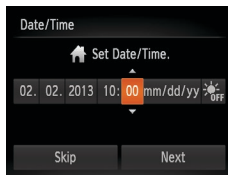

Cover

Preliminary Notes and Legal Information

Contents: Basic Operations

Basic Guide

Advanced Guide

1 Camera Basics

2 Creative Shot Mode

3 Auto Mode/Hybrid Auto Mode

4 Other Shooting Modes

5 P Mode

6 Playback Mode

7 Wi-Fi Functions

8 Setting Menu

9 Accessories

10 Appendix

Index



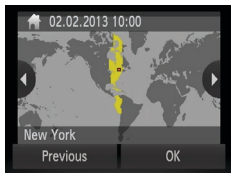

3 Set the home time zone.

- Touch [◀][▶] to choose your home time zone.

4 Finish the setup process.

- Touch [OK] when finished. After a confirmation message, the setting screen is no longer displayed.
- To turn off the camera, press the ON/OFF button.



- Unless you set the date and time, the [Date/Time] screen will be displayed each time you turn the camera on. Specify the correct information.



- To set daylight saving time (1 hour ahead), touch [☀️] and choose [☀️] in step 2.

Changing the Date and Time

Adjust the date and time as follows.

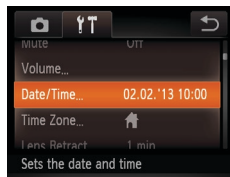

1 Access the camera menu.

- Touch [FUNC.], and then touch [MENU].

2 Choose [Date/Time].

- Touch the [Y/T] tab.
- Drag up or down across the screen to choose [Date/Time].
- Touch [Date/Time].

3 Change the date and time.

- Follow step 2 in “Setting the Date and Time” (13) to adjust the settings.
- Double-touch [↶] to close the menu.

Cover

Preliminary Notes and
Legal Information

Contents: Basic
Operations

Basic Guide

Advanced Guide

1 Camera Basics

2 Creative Shot
Mode

3 Auto Mode/
Hybrid Auto Mode

4 Other Shooting
Modes

5 P Mode

6 Playback Mode

7 Wi-Fi Functions

8 Setting Menu

9 Accessories

10 Appendix

Index





- Date/time settings can be retained for about 3 weeks by the camera's built-in date/time battery (backup battery) after the battery pack is removed.
- The date/time battery will be charged in about 4 hours once you charge the main battery or connect the camera to an AC adapter kit (sold separately, 112), even if the camera is left off.
- Once the date/time battery is depleted, the [Date/Time] screen will be displayed when you turn the camera on. Follow the steps on 13 to set the date and time.



Display Language

Change the display language as needed.

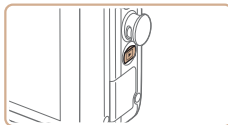

1 Enter Playback mode.

- Press the button.

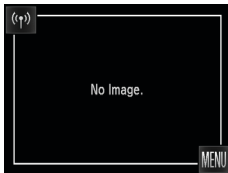

2 Access the setting screen.

- Touch and hold [MENU] until the setting screen is displayed.

| | | |
|-------------|-----------|---------|
| English | Suomi | Magyar |
| Deutsch | Norsk | Türkçe |
| Français | Svenska | 繁體中文 |
| Nederlands | Español | 한국어 |
| Dansk | 简体中文 | മലയാളം |
| Italiano | Русский | العربية |
| Українська | Português | Română |
| B. Malaysia | Ελληνικά | فارسی |
| Indonesian | Polski | हिन्दी |
| Tiếng Việt | Čeština | 日本語 |

3 Set the display language.

- Touch a display language to choose it, and then touch the language again.
- ▶ Once the display language has been set, the setting screen is no longer displayed.



- If there are images on the memory card, touch [FUNC.] in the lower left to access [MENU].



- You can also change the display language by touching [FUNC.] and then [MENU], and then choosing [Language] on the tab.

Cover

Preliminary Notes and Legal Information

Contents: Basic Operations

Basic Guide

Advanced Guide

1 Camera Basics

2 Creative Shot Mode

3 Auto Mode/Hybrid Auto Mode

4 Other Shooting Modes

5 P Mode

6 Playback Mode

7 Wi-Fi Functions

8 Setting Menu

9 Accessories

10 Appendix

Index



Trying the Camera Out

Follow these instructions to turn the camera on, shoot still images or movies, and then view them.

Shooting (Smart Auto)

For fully automatic selection of the optimal settings for specific scenes, simply let the camera determine the subject and shooting conditions.



1 Turn the camera on.

- Press the ON/OFF button.
- ▶ The startup screen is displayed.



2 Enter [AUTO] mode.

- Set the mode switch to [A].

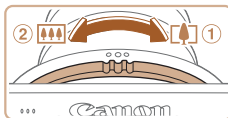
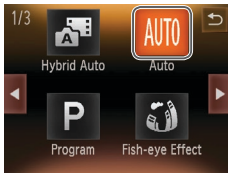

- Touch [AUTO], touch [◀▶] or quickly drag left or right on the screen, and then touch [AUTO] to choose it.
- To confirm your choice, touch [OK].

- Aim the camera at the subject. The camera will make a slight clicking noise as it determines the scene.
- ▶ Icons representing the scene and image stabilization mode are displayed in the upper right of the screen.
- ▶ Frames displayed around any detected subjects indicate that they are in focus.

3 Compose the shot.

- To zoom in and enlarge the subject, turn the zoom ring toward ① (telephoto), and to zoom away from the subject, turn it toward ② (wide angle).

Cover

Preliminary Notes and Legal Information

Contents: Basic Operations

Basic Guide

Advanced Guide

1 Camera Basics

2 Creative Shot Mode

3 Auto Mode/ Hybrid Auto Mode

4 Other Shooting Modes

5 P Mode

6 Playback Mode

7 Wi-Fi Functions

8 Setting Menu

9 Accessories

10 Appendix

Index



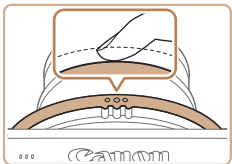
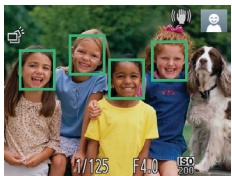
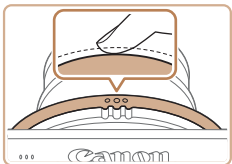

4 Shoot.

Shooting Still Images

① Focus.

- Press the shutter ring lightly, halfway down. The camera beeps twice after focusing, and AF frames are displayed to indicate image areas in focus.

② Shoot.

- Press the shutter ring all the way down.
- ▶ As the camera shoots, a shutter sound is played, and in low-light conditions, the flash fires automatically.
- Keep the camera still until the shutter sound ends.
- ▶ Your shot is only displayed until the camera is ready to shoot again.



Elapsed Time

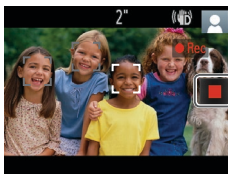

Shooting Movies

① Start shooting.

- Touch [●]. The camera beeps once as recording begins, and [●Rec] is displayed with the elapsed time.
- ▶ Black bars displayed on the top and bottom edges of the screen indicate image areas not recorded.
- ▶ Frames displayed around any detected faces indicate that they are in focus.
- ▶ In low-light conditions, the flash is activated automatically, and [Flash] is displayed.

② Finish shooting.

- Touch [■]. The camera beeps twice as recording stops.



- If you set the mode switch to [M] in step 2, you can shoot multiple still images with effects for each shot (Creative Shot mode) (32).

Cover

Preliminary Notes and
Legal Information

Contents: Basic
Operations

Basic Guide

Advanced Guide

1 Camera Basics

2 Creative Shot
Mode

3 Auto Mode/
Hybrid Auto Mode

4 Other Shooting
Modes

5 P Mode

6 Playback Mode

7 Wi-Fi Functions

8 Setting Menu

9 Accessories

10 Appendix

Index



Viewing

After shooting images or movies, you can view them on the screen as follows.

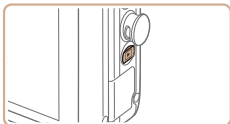

1 Enter Playback mode.

- Press the button.
- ▶ Your last shot is displayed.

2 Browse through your images.

- To view the next image, drag right to left across the screen, and to view the previous image, drag left to right.
- You can also view the next image by touching the right edge of the screen (in the area indicated by frame ① at left). In this case, is displayed. Similarly, you can view the previous image by touching the left edge of the screen (in the area indicated by frame ② at left), and in this case, is displayed.
- Touch and hold to browse through images quickly.
- Movies are identified by a . To play movies, go to step 3.



②

①



Volume

3 Play movies.

- Touch to start playback.
- To adjust the volume, quickly drag up or down across the screen during playback.
- ▶ After the movie is finished, is displayed.



- To switch to Shooting mode from Playback mode when the lens is out, press the shutter ring halfway (except during battery charging 11)).

Erasing the Images

You can choose and erase unneeded images one by one. Be careful when erasing images, because they cannot be recovered.

1 Choose an image to erase.

- Drag left or right across the screen to choose an image.

Cover

Preliminary Notes and Legal Information

Contents: Basic Operations

Basic Guide

Advanced Guide

1 Camera Basics

2 Creative Shot Mode

3 Auto Mode/Hybrid Auto Mode

4 Other Shooting Modes

5 P Mode

6 Playback Mode

7 Wi-Fi Functions

8 Setting Menu

9 Accessories

10 Appendix

Index





2 Erase the image.

- Touch [FUNC.], drag up or down on the screen, and then touch [] to choose it.



- After [Erase?] is displayed, touch [Erase].
- ▶ The current image is now erased.
- To cancel erasure, touch [Cancel].

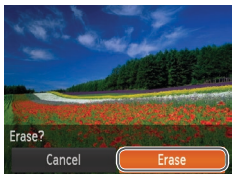

- Images can also be erased by using Touch Actions (76).
- You can also erase all images at once (73).

Using the Software

The software on the included DIGITAL CAMERA Solution Disk (CD-ROM) (2) is introduced below, with instructions for installation, and saving images to a computer.

Software

After installing the software on the CD-ROM, you can do the following things on your computer.

CameraWindow

- Import images and change camera settings
- ImageBrowser EX**
- Manage images: view, search, and organize
- Print and edit images

Auto Update Function

Using the included software, you can update to the latest version, and download new functions via the Internet (some software excluded). Be sure to install the software on a computer with an Internet connection so you can use this function.



- Internet access is required to use this function, and any ISP account charges and access fees must be paid separately.

Cover

Preliminary Notes and Legal Information

Contents: Basic Operations

Basic Guide

Advanced Guide

1 Camera Basics

2 Creative Shot Mode

3 Auto Mode/Hybrid Auto Mode

4 Other Shooting Modes

5 P Mode

6 Playback Mode

7 Wi-Fi Functions

8 Setting Menu

9 Accessories

10 Appendix

Index



PDF Manuals

You can download PDF manuals from the following URL.
<http://www.canon.com/icpd/>

Camera User Guide

- Refer to this guide for a more in-depth understanding of camera operation.

Software Guide

- Refer to this guide when using the included software. The guide can be accessed from the help system of included software (some software excluded).

System Requirements

The included software can be used on the following computers.

| | Windows | Macintosh |
|-----------------------------|---|--|
| Operating System*1 | Windows 8 Windows 7 SP1 Windows Vista SP2 Windows XP SP3 | Mac OS X 10.6 Mac OS X 10.7 Mac OS X 10.8*2 |
| Computer | Computers running one of the above operating systems (preinstalled), with an included USB port and Internet connection | |
| Processor | Still images 1.6 GHz or higher Movies Core 2 Duo 2.6 GHz or higher | Still images Mac OS X 10.7 – 10.8: Core 2 Duo or higher, Mac OS X 10.6: Core Duo 1.83 GHz or higher Movies Core 2 Duo 2.6 GHz or higher |
| RAM | Still images Windows 8 (64 bit), Windows 7 (64 bit): 2 GB or more, Windows 8 (32 bit), Windows 7 (32 bit), Windows Vista: 1 GB or more, Windows XP: 512 MB or more Movies 2 GB or more | Still images Mac OS X 10.7 – 10.8: 2 GB or more, Mac OS X 10.6: 1 GB or more Movies 2 GB or more |
| Interfaces | USB and Wi-Fi | |
| Free Hard Disk Space | 440 MB or more*3 | 550 MB or more*3 |
| Display | 1024 x 768 resolution or higher | |

Cover

Preliminary Notes and Legal Information

Contents: Basic Operations

Basic Guide

Advanced Guide

1 Camera Basics

2 Creative Shot Mode

3 Auto Mode/Hybrid Auto Mode

4 Other Shooting Modes

5 P Mode

6 Playback Mode

7 Wi-Fi Functions

8 Setting Menu

9 Accessories

10 Appendix

Index



*1 Wi-Fi image transfer to a computer requires Windows 8, Windows 7 SP1, Mac OS X 10.6.8, Mac OS X 10.7, or Mac OS X 10.8.2 or later.

*2 Information on computer models compatible with Mac OS X 10.8 is available on the Apple website.

*3 Includes Silverlight 5.1 (max. 100 MB). Additionally, in Windows XP, Microsoft .NET Framework 3.0 or later (max. 500 MB) must be installed. Installation may take some time, depending on computer performance.



- Check the Canon website for the latest system requirements, including supported OS versions.

Installing the Software

Windows 7 and Mac OS X 10.6 are used here for the sake of illustration. Using the software auto update function, you can update to the latest version and download new functions via the Internet (some software excluded), so be sure to install the software on a computer with an Internet connection.

What you will need:

- Computer
- Interface cable (📖2)
- Included CD-ROM (DIGITAL CAMERA Solution Disk) (📖2)

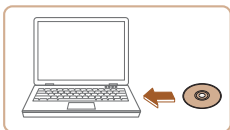

1 Insert the CD-ROM in the computer's CD-ROM drive.

- Insert the included CD-ROM (DIGITAL CAMERA Solution Disk) (📖2) in the computer's CD-ROM drive.

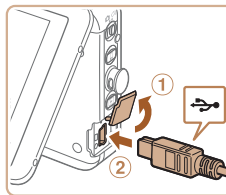

- On a Macintosh computer, after inserting the disc, double-click the desktop disc icon to open it, and then double-click the [📀] icon displayed.

2 Begin the installation.

- Click [Easy Installation] and follow the on-screen instructions to complete the installation process.

3 When a message is displayed prompting you to connect the camera, connect it to a computer.

- With the camera turned off, open the cover (①). With the smaller plug of the included interface cable (📖2) in the orientation shown, insert the plug fully into the camera terminal (②).

Cover

Preliminary Notes and Legal Information

Contents: Basic Operations

Basic Guide

Advanced Guide

1 Camera Basics

2 Creative Shot Mode

3 Auto Mode/ Hybrid Auto Mode

4 Other Shooting Modes

5 P Mode

6 Playback Mode

7 Wi-Fi Functions

8 Setting Menu

9 Accessories

10 Appendix

Index



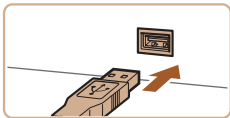

- Insert the larger plug of the interface cable in the computer's USB port. For details about USB connections on the computer, refer to the computer user manual.



4 Install the files.

- Turn the camera on, and follow the on-screen instructions to complete the installation process.
- ▶ The software will connect to the Internet to update to the latest version and download new functions. Installation may take some time, depending on computer performance and the Internet connection.
- Click [Finish] or [Restart] on the screen after installation and remove the CD-ROM when the desktop is displayed.
- Turn the camera off and disconnect the cable.



- When not connected to the Internet, there are the following limitations.
 - The screen in step 3 will not be displayed.
 - Some functions may not be installed.
- The first time you connect the camera to the computer, drivers will be installed, so it may take a few minutes until camera images are accessible.
- If you have several cameras that were bundled with ImageBrowser EX on the included CD-ROMs, be sure to use each camera with their included CD-ROM and follow the on-screen installation instructions for each. Doing so will ensure that each camera will receive the correct updates and new functions via the auto update function.





Saving Images to a Computer

Windows 7 and Mac OS X 10.6 are used here for the sake of illustration.

1 Connect the camera to the computer.

- Follow step 3 in “Installing the Software” (21) to connect the camera to a computer.

2 Turn the camera on to access CameraWindow.

- Press the  button to turn the camera on.
- On a Macintosh computer, CameraWindow is displayed when a connection is established between the camera and computer.
- For Windows, follow the steps introduced below.
- In the screen that displays, click the  link to modify the program.
- Choose [Downloads Images From Canon Camera using Canon CameraWindow] and then click [OK].

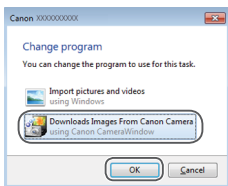
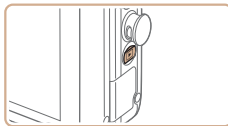

Cover

Preliminary Notes and Legal Information

Contents: Basic Operations

Basic Guide

Advanced Guide

1 Camera Basics

2 Creative Shot Mode

3 Auto Mode/ Hybrid Auto Mode

4 Other Shooting Modes

5 P Mode

6 Playback Mode

7 Wi-Fi Functions

8 Setting Menu

9 Accessories

10 Appendix

Index





- Double click [].

CameraWindow

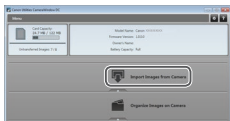

3 Save the images to the computer.

- Click [Import Images from Camera], and then click [Import Untransferred Images].
- ▶ Images are now saved to the Pictures folder on the computer, in separate folders named by date.
- After images are saved, close CameraWindow, press the ON/OFF button to turn the camera off, and unplug the cable.
- For instructions on viewing images on a computer, refer to the *Software Guide* ( 20).



- In Windows 7, if the screen in step 2 is not displayed, click the [] icon in the taskbar.
- To start CameraWindow in Windows Vista or XP, click [Downloads Images From Canon Camera using Canon CameraWindow] on the screen displayed when you turn the camera on in step 2. If CameraWindow is not displayed, click the [Start] menu and choose [All Programs] ▶ [Canon Utilities] ▶ [CameraWindow] ▶ [CameraWindow].
- On a Macintosh computer, if CameraWindow is not displayed after step 2, click the [CameraWindow] icon in the Dock (the bar at the bottom of the desktop).



- Although you can save images to a computer simply by connecting your camera to the computer without using the software, the following limitations apply.
 - It may take a few minutes after you connect the camera to the computer until camera images are accessible.
 - Images shot in vertical orientation may be saved in horizontal orientation.
 - Some problems may occur when saving images or image information, depending on the operating system version, the software in use, or image file sizes.
 - Some functions provided by the software may not be available, such as movie editing.

Cover

Preliminary Notes and Legal Information

Contents: Basic Operations

Basic Guide

Advanced Guide

1 Camera Basics

2 Creative Shot Mode

3 Auto Mode/Hybrid Auto Mode

4 Other Shooting Modes

5 P Mode

6 Playback Mode

7 Wi-Fi Functions

8 Setting Menu

9 Accessories

10 Appendix

Index



System Map

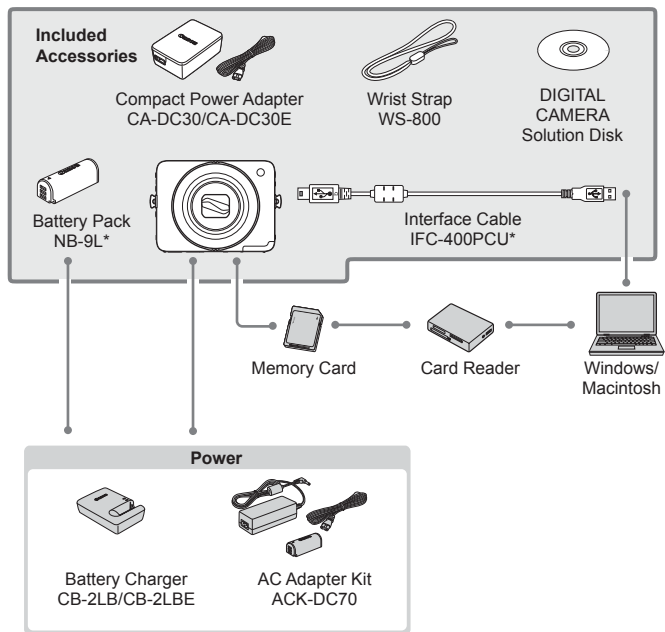

* Also available for purchase separately.

Use of genuine Canon accessories is recommended.

This product is designed to achieve excellent performance when used with genuine Canon accessories.

Canon shall not be liable for any damage to this product and/or accidents such as fire, etc., caused by the malfunction of non-genuine Canon accessories (e.g., a leakage and/or explosion of a battery pack). Please note that this warranty does not apply to repairs arising out of the malfunction of non-genuine Canon accessories, although you may request such repairs on a chargeable basis.

Note that availability varies by area, and some accessories may no longer be available.

Cover

Preliminary Notes and Legal Information

Contents: Basic Operations

Basic Guide

Advanced Guide

1 Camera Basics

2 Creative Shot Mode

3 Auto Mode/Hybrid Auto Mode

4 Other Shooting Modes

5 P Mode

6 Playback Mode

7 Wi-Fi Functions

8 Setting Menu

9 Accessories

10 Appendix

Index



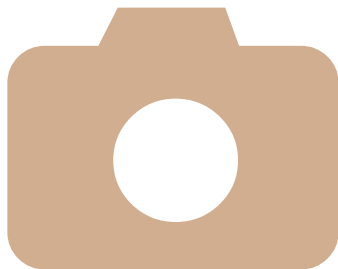

Advanced Guide

1

Camera Basics

Practical guide that introduces other camera basics and describes shooting and playback options

| | |
|--------------------------------|----|
| On/Off | 26 |
| Shutter Ring..... | 27 |
| Holding the Camera | 28 |
| Shooting Display Options | 29 |
| FUNC. Menu | 29 |
| MENU Menu | 30 |
| Indicator Display | 31 |

Cover

Preliminary Notes and
Legal Information

Contents: Basic
Operations

Basic Guide

Advanced Guide

1 Camera Basics

2 Creative Shot
Mode

3 Auto Mode/
Hybrid Auto Mode

4 Other Shooting
Modes

5 P Mode

6 Playback Mode

7 Wi-Fi Functions

8 Setting Menu

9 Accessories

10 Appendix

Index



On/Off



Shooting Mode

- Press the ON/OFF button to turn the camera on and prepare for shooting.
- To turn the camera off, press the ON/OFF button again.

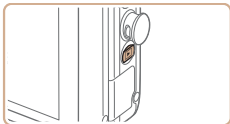

Playback Mode

- Press the <▶> button to turn the camera on and view your shots.
- To switch between Shooting and Playback mode when the camera is on, press the <▶> button.



- To switch to Shooting mode from Playback mode when the lens is out, press the shutter ring halfway (📖27) (except during battery charging (📖11)).
- The lens will be retracted after about one minute once the camera is in Playback mode.

Power-Saving Features (Auto Power Down)

As a way to conserve battery power, the camera automatically deactivates the screen (Display Off) and then turns itself off after a specific period of inactivity.

Power Saving in Shooting Mode

The screen is automatically deactivated after about one minute of inactivity. In about two more minutes, the lens is retracted and the camera turns itself off. To activate the screen and prepare for shooting when the screen is off but the lens is still out, press the shutter ring halfway (📖27).

Power Saving in Playback Mode

The camera turns itself off automatically after about five minutes of inactivity.



- Power saving is not active while the camera is connected to a computer via the interface cable (📖22), or when connected to other devices via Wi-Fi (📖80).

Cover

Preliminary Notes and
Legal Information

Contents: Basic
Operations

Basic Guide

Advanced Guide

1 Camera Basics

2 Creative Shot
Mode

3 Auto Mode/
Hybrid Auto Mode

4 Other Shooting
Modes

5 P Mode

6 Playback Mode

7 Wi-Fi Functions

8 Setting Menu

9 Accessories

10 Appendix

Index



Shutter Ring

To ensure your shots are in focus, always begin by holding the shutter ring halfway down, and once the subject is in focus, press the ring all the way down to shoot.

In this manual, shutter ring operations are described as pressing the ring *halfway* or *all the way down*.

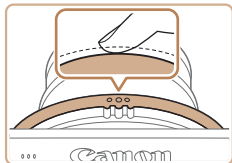

1 Press halfway. (Press lightly to focus.)

- Press the shutter ring halfway. The camera beeps twice, and AF frames are displayed around image areas in focus.

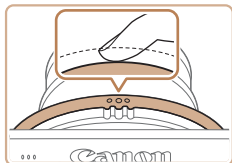

2 Press all the way down. (From the halfway position, press fully to shoot.)

- ▶ The camera shoots, as a shutter sound is played.
- Keep the camera still until the shutter sound ends.
- You can also press the bottom of the shutter ring halfway and all the way.

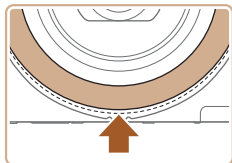

- Images may be out of focus if you shoot without initially pressing the shutter ring halfway.
- Length of shutter sound playback varies depending on the time required for the shot. It may take longer in some shooting scenes, and images will be blurry if you move the camera (or the subject moves) before the shutter sound ends.

Cover

Preliminary Notes and
Legal Information

Contents: Basic
Operations

Basic Guide

Advanced Guide

1 Camera Basics

2 Creative Shot
Mode

3 Auto Mode/
Hybrid Auto Mode

4 Other Shooting
Modes

5 P Mode

6 Playback Mode

7 Wi-Fi Functions

8 Setting Menu

9 Accessories

10 Appendix

Index



Holding the Camera

While holding the camera naturally, you can shoot from a variety of angles best suited to the scene or your shooting objective.

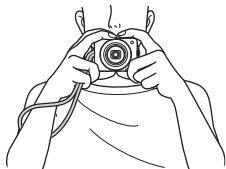

- Place the strap around your wrist.
- When shooting, keep your arms close to your body and hold the camera securely to prevent it from moving. Do not rest your fingers on the flash.

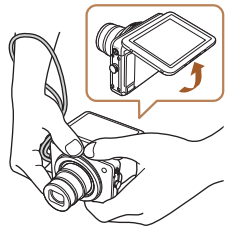

- The angle of the screen can be adjusted for easy viewing.
- You can press the shutter ring from the bottom. To capture a desired subject or compose a shot, you can hold the camera in a variety of comfortable positions.

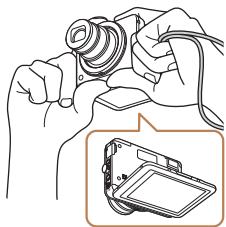

- If you turn the camera upside-down in Shooting mode, images on the screen will be rotated for easier viewing. Your shots are also rotated 180°.



- When the camera is not in use, keep the screen closed.
- The screen can only open to approximately 90°. Be careful not to open the screen any further than this, as it will damage the camera.



- Images taken upside down (except movies in [1080] or [1280]) (74) can also be rotated.

Cover

Preliminary Notes and Legal Information

Contents: Basic Operations

Basic Guide

Advanced Guide

1 Camera Basics

2 Creative Shot Mode

3 Auto Mode/Hybrid Auto Mode

4 Other Shooting Modes

5 P Mode

6 Playback Mode

7 Wi-Fi Functions

8 Setting Menu

9 Accessories

10 Appendix

Index



Shooting Display Options

Touch [DISP.] to view other information on the screen, or to hide the information. For details on the information displayed, see “On-Screen Information” (124).



Information is displayed



No information is displayed



- Screen brightness is automatically increased by the night display function when you are shooting under low light, making it easier to check how shots are composed. However, on-screen image brightness may not match the brightness of your shots. Note that any on-screen image distortion or jerky subject motion will not affect recorded images.
- For playback display options, see “Switching Display Modes” (66).

FUNC. Menu

Configure commonly used functions through the FUNC. menu as follows. Note that menu items and options vary depending on the shooting mode (126 – 127) or playback mode (128).

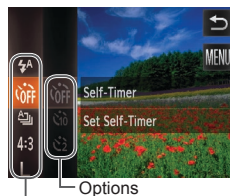

Menu Items

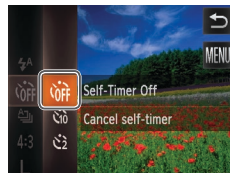

1 Access the FUNC. menu.

- Touch [FUNC.].

2 Choose a menu item.

- Drag the menu up or down to scroll it, or touch an item to choose it.
- You can also scroll the menu by dragging up or down outside of the menu area.
- Touch your chosen menu item again, or touch its description at right.

3 Choose an option.

- Drag the options up or down to scroll them, or touch an option to choose it.
- You can also scroll the options by dragging up or down outside of the option area.

Cover

Preliminary Notes and Legal Information

Contents: Basic Operations

Basic Guide

Advanced Guide

1 Camera Basics

2 Creative Shot Mode

3 Auto Mode/Hybrid Auto Mode

4 Other Shooting Modes

5 P Mode

6 Playback Mode

7 Wi-Fi Functions

8 Setting Menu

9 Accessories

10 Appendix

Index



4 Finish the setup process.

- Touch your chosen option again, or touch [↩].
- ▶ The screen before you touched [FUNC.] in step 1 is displayed again, showing the option you configured.



- To undo any accidental setting changes, you can restore the camera's default settings (📖 110).
- On the screen in step 2, you can also choose options by touching their descriptions at right.

MENU Menu

Configure a variety of camera functions through other menus as follows. Menu items are grouped by purpose on tabs, such as shooting [📷], playback [▶], and so on. Note that available settings vary depending on the selected shooting or playback mode (📖 127 – 128).



1 Access the menu.

- Touch [FUNC.], and then touch [MENU].

2 Choose a tab.

- Touch a tab to choose it.

Cover

Preliminary Notes and
Legal Information

Contents: Basic
Operations

Basic Guide

Advanced Guide

1 Camera Basics

2 Creative Shot
Mode

3 Auto Mode/
Hybrid Auto Mode

4 Other Shooting
Modes

5 P Mode

6 Playback Mode

7 Wi-Fi Functions

8 Setting Menu

9 Accessories

10 Appendix

Index



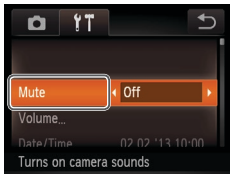

3 Choose a setting.

- Drag the settings up or down to scroll them, or touch a setting to choose it.
- To choose settings with options not shown, first touch the setting to switch screens, and then either drag the settings up or down to scroll them or touch a setting to choose it.
- To return to the previous screen, touch [↩].

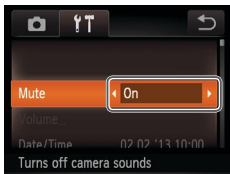

4 Choose an option.

- For options displayed with [◀|▶] on either side, touch [◀|▶] to change the option.
- For options displayed with a bar to indicate the level, touch the desired position on the bar.

5 Finish the setup process.

- Touch [↩] to return to the screen displayed before you touched [FUNC.] in step 1.



- To undo any accidental setting changes, you can restore the camera's default settings (110).
- On the screen in step 2, you can also choose a tab by turning the zoom ring.

Indicator Display

The indicator (3) lights up or blinks depending on the camera status.

| Indicator | Color | Indicator Status | Camera Status |
|-----------------|--------|------------------|---|
| Power Lamp | Green | On | Connected to a computer (22), or display off (26, 107) |
| | | Blinking | Starting up, recording/reading/transmitting images, or connected/transmitting via Wi-Fi |
| USB Charge Lamp | Orange | On | Charging in progress |
| | | Blinking | Charging error |



- When the power lamp blinks green, never turn the camera off, open the memory card or battery cover, or shake or jolt the camera, which may corrupt images or damage the camera or memory card.

Cover

Preliminary Notes and Legal Information

Contents: Basic Operations

Basic Guide

Advanced Guide

1 Camera Basics

2 Creative Shot Mode

3 Auto Mode/Hybrid Auto Mode

4 Other Shooting Modes

5 P Mode

6 Playback Mode

7 Wi-Fi Functions

8 Setting Menu

9 Accessories

10 Appendix

Index



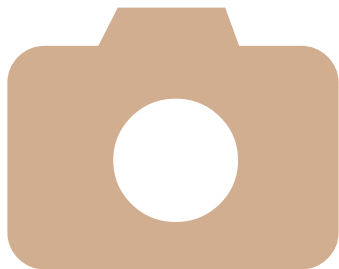

2

Creative Shot Mode

Shoot multiple still images with effects using camera-determined settings

Shooting (Creative Shot)33

Viewing.....33

Cover

Preliminary Notes and
Legal Information

Contents: Basic
Operations

Basic Guide

Advanced Guide

1 Camera Basics

2 Creative Shot
Mode

3 Auto Mode/
Hybrid Auto Mode

4 Other Shooting
Modes

5 P Mode

6 Playback Mode

7 Wi-Fi Functions

8 Setting Menu

9 Accessories

10 Appendix

Index



Shooting (Creative Shot)

The camera determines the subject and shooting conditions, automatically applying special effects and recomposing the shot to emphasize the subject. Six still images are recorded for each shot. You can capture multiple still images with effects using camera-determined settings. Note that the flash will not fire in this mode.



1 Enter [Creative Shot] mode.

- Set the mode switch to [Creative Shot].

2 Shoot.

- Follow steps 3 – 4 in “Shooting (Smart Auto)” (16) to shoot.
 - ▶ As the camera shoots, the shutter sound is played three times.
- Keep the camera still until the shutter sound ends.
- ▶ After the six images are displayed in succession, they are displayed simultaneously for about two seconds.
- If you touch the screen while the images are displayed, [Group Playback] is displayed, and the images remain displayed until you touch it again.
- For full-screen display, choose the image by touching it.
- For full-screen display, choose the image by touching it. To return to the original display, touch [Group Playback].



Viewing

Normally, only images without effects that you shoot in [Creative Shot] mode will be displayed, but you can also view each of the six versions of the shot individually by viewing the group.

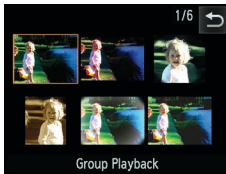

1 Choose a grouped image.

- Drag left or right across the screen to choose an image shot in [Creative Shot] mode, and then touch it.
- ▶ The images in the group are displayed in an index.

2 View individual images in the group.

- Touch an image to choose it, and touch it again to view it in single-image display.
- In single-image display, drag left or right on the screen to display other images in the group.
- To cancel group playback, touch [Group Playback].

- ⚠ If you erase a grouped image (73), all images in the group are also erased. Be careful when erasing images.





- The simultaneous display after step 2 in “Shooting (Creative Shot)” (📖33) is only shown immediately after you shoot.
- During group playback, you can switch to single-image display to use menu functions (accessed by touching [FUNC.]) or magnify images (“Magnifying Images” (📖71)). You can erase all images or add them to a photobook by choosing [All Images in Group] in “Erasing All Images” (📖73) or “Adding Images to a Photobook” (📖116).

Grouped Images

- To ungroup images so that you can view them individually, touch [FUNC.], touch [MENU], choose [Group Images] on the [📺] tab, and then choose [Off] (📖30). However, grouped images cannot be ungrouped during individual playback.
- Grouped images can be viewed individually when played back using Image Search (📖69). In this case, images are temporarily ungrouped.
- Grouped images cannot be tagged as favorites (📖75), edited (📖74 – 77), printed (📖115), or added to a Photobook (📖116). To do these things, either view grouped images individually or cancel grouping first.

Cover

Preliminary Notes and
Legal Information

Contents: Basic
Operations

Basic Guide

Advanced Guide

1 Camera Basics

2 Creative Shot
Mode

3 Auto Mode/
Hybrid Auto Mode

4 Other Shooting
Modes

5 P Mode

6 Playback Mode

7 Wi-Fi Functions

8 Setting Menu

9 Accessories

10 Appendix

Index



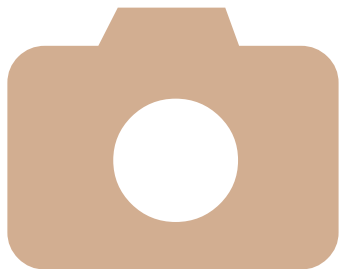

3

Auto Mode/Hybrid Auto Mode

Convenient mode for easy shots with greater control over shooting

| | |
|---|----|
| Shooting With Camera-Determined Settings..... | 36 |
| Common, Convenient Features..... | 41 |
| Using Face ID | 44 |
| Image Customization Features..... | 49 |

| | |
|-----------------------------------|----|
| Helpful Shooting Features | 50 |
| Customizing Camera Operation..... | 51 |

| |
|---|
| Cover |
| Preliminary Notes and Legal Information |
| Contents: Basic Operations |
| Basic Guide |
| Advanced Guide |
| 1 Camera Basics |
| 2 Creative Shot Mode |
| 3 Auto Mode/Hybrid Auto Mode |
| 4 Other Shooting Modes |
| 5 P Mode |
| 6 Playback Mode |
| 7 Wi-Fi Functions |
| 8 Setting Menu |
| 9 Accessories |
| 10 Appendix |
| Index |



Shooting With Camera-Determined Settings

For fully automatic selection at optimal settings for specific scenes, simply let the camera determine the subject and shooting conditions.

Still Images

Movies

Shooting (Smart Auto)



1 Turn the camera on.

- Press the ON/OFF button.
- ▶ The startup screen is displayed.



2 Enter [AUTO] mode.

- Set the mode switch to [CAMERA].



- Touch [AUTO], touch [◀▶] or quickly drag left or right on the screen, and then touch [AUTO] to choose it.
- To confirm your choice, touch [OK].

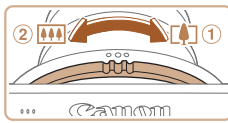
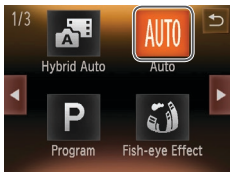

Zoom Bar

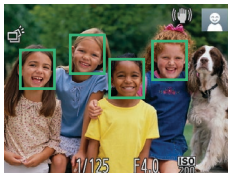
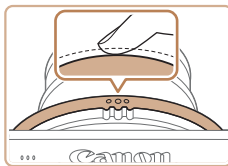

- Aim the camera at the subject. The camera will make a slight clicking noise as it determines the scene.
- ▶ Icons representing the scene and image stabilization mode are displayed in the upper right of the screen (39, 40).
- ▶ Frames displayed around any detected subjects indicate that they are in focus.

3 Compose the shot.

- To zoom in and enlarge the subject, turn the zoom ring toward ① (telephoto), and to zoom away from the subject, turn it toward ② (wide angle). (A zoom bar showing the zoom position is displayed.)

4 Shoot.

Shooting Still Images

① Focus.

- Press the shutter ring halfway. The camera beeps twice after focusing, and AF frames are displayed to indicate image areas in focus.
- ▶ Several AF frames are displayed when multiple areas are in focus.

Cover

Preliminary Notes and Legal Information

Contents: Basic Operations

Basic Guide

Advanced Guide

1 Camera Basics

2 Creative Shot Mode

3 Auto Mode/Hybrid Auto Mode

4 Other Shooting Modes

5 P Mode

6 Playback Mode

7 Wi-Fi Functions

8 Setting Menu

9 Accessories

10 Appendix

Index



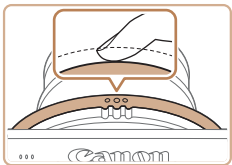

② Shoot.

- Press the shutter ring all the way down.
- ▶ As the camera shoots, a shutter sound is played, and in low-light conditions, the flash fires automatically.
- Keep the camera still until the shutter sound ends.
- ▶ Your shot is only displayed until the camera is ready to shoot again.

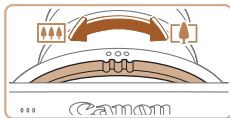

② Resize the subject and recompose the shot as needed.

- To resize the subject, repeat the operations in step 3 (📖36). However, note that the sound of camera operations will be recorded, and movies shot at zoom factors shown in blue will look grainy.
- When you recompose shots, the focus stays the same but the brightness and colors will be automatically adjusted.

③ Finish shooting.

- Touch [■]. The camera beeps twice as recording stops.
- Recording will stop automatically when the memory card becomes full.



Elapsed Time



Shooting Movies

① Start shooting.

- Touch [●]. The camera beeps once as recording begins, and [●Rec] is displayed with the elapsed time.
- ▶ Black bars displayed on the top and bottom edges of the screen indicate image areas not recorded.
- ▶ Frames displayed around any detected faces indicate that they are in focus.
- ▶ In low-light conditions, the flash is activated automatically, and [🔆] is displayed.

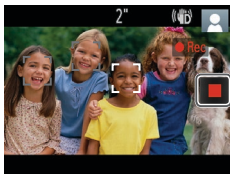

Cover

Preliminary Notes and Legal Information

Contents: Basic Operations

Basic Guide

Advanced Guide

1 Camera Basics

2 Creative Shot Mode

3 Auto Mode/Hybrid Auto Mode

4 Other Shooting Modes

5 P Mode

6 Playback Mode

7 Wi-Fi Functions

8 Setting Menu

9 Accessories

10 Appendix

Index



Shooting in Hybrid Auto Mode

You can make a short movie of the day (digest movie). Just by shooting still images, the camera will automatically record a movie clip of the scene immediately before each shot.

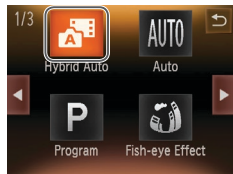

1 Enter [A] mode.

- Follow step 2 in “Shooting (Smart Auto)” (📖36) and choose [A].

2 Shoot.

- Follow steps 3 – 4 in “Shooting (Smart Auto)” (📖16) to shoot a still image.
- To beautifully capture a digest movie, which is created by automatically recording about 2 – 4 seconds of the scene before each shot, aim the camera at the subject about four seconds before shooting a still image.
- Some camera sounds will be muted. Sounds are not played when you press the shutter ring halfway, or trigger the self-timer (📖106).



- Battery life is shorter in this mode than in [AUTO] mode, because digest movies are recorded for each shot.
- Digest movies may not be recorded if you shoot a still image immediately after turning the camera on, choosing [A] mode, turning the camera upside-down, or operating the camera in other ways.
- Camera operating sounds will be recorded in digest movies.



- Although the digest movie recorded on a particular day constitutes a single file, a single clip (chapter) is created with each shot, and the clip can be edited (📖79).
- Digest movies are saved as separate movie files in the following cases even if they were recorded on the same day in [A] mode.
 - If the digest movie file size reaches approximately 4 GB or the total recording time reaches approximately 29 minutes and 59 seconds
 - If the daylight saving time (📖14) or time zone (📖106) settings have been changed

Digest Movie Playback

You can play digest movies either by viewing still images shot in [A] mode on the same day as the movies or by specifying the date of movies to play (📖67).

Still Images



- A flashing [A] icon warns that images are more likely to be blurred by camera shake. In this case, mount the camera on a tripod or take other measures to keep it still.
- If your shots are dark despite the flash firing, move closer to the subject. For details on the flash range, see “Flash Range” (📖130).
- The subject may be too close if the camera only beeps once when you press the shutter ring halfway. For details on the focusing range (shooting range), see “Shooting Range” (📖130).
- To assist in focusing, the lamp may be activated when you press the shutter ring halfway down in low-light conditions.
- The shutter sound will not be played when the Sleeping and Babies (Sleeping) icons (📖39) are displayed.



- You can change how long images are displayed after shots (📖51).

Cover

Preliminary Notes and Legal Information

Contents: Basic Operations

Basic Guide

Advanced Guide

1 Camera Basics

2 Creative Shot Mode

3 Auto Mode/ Hybrid Auto Mode

4 Other Shooting Modes

5 P Mode

6 Playback Mode

7 Wi-Fi Functions

8 Setting Menu

9 Accessories

10 Appendix

Index



Movies



- The camera may become warm when shooting movies repeatedly over an extended period. This does not indicate damage.

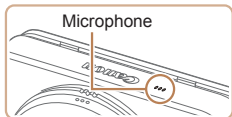

- Keep your fingers away from the microphone while shooting movies. Blocking the microphone may prevent audio from being recorded or may cause the recording to sound muffled.

- Avoid touching camera controls other than the screen when shooting movies, because sounds made by the camera will be recorded.



- Audio recording is monaural.

Scene Icons

In [AUTO] and [A] modes, shooting scenes determined by the camera are indicated by the icon displayed, and corresponding settings are automatically selected for optimal focusing, subject brightness, and color. Depending on the scene, continuous images may be shot (p.40).

| | Background | | | | |
|-----------------------------|------------|---------|-------|---------|------------|
| Subject | Normal | Backlit | Dark* | Sunsets | Spotlights |
| People | | | | – | |
| In Motion | | | – | – | – |
| Shadows on Face | | – | – | – | – |
| Smiling | | | – | – | – |
| Sleeping | | | – | – | – |
| Babies | | | – | – | – |
| Smiling | | | – | – | – |
| Sleeping | | | – | – | – |
| Children (In Motion) | | | – | – | – |
| Other Subjects | | | | | |
| In Motion | | | – | – | – |
| At Close Range | | | – | – | |

* Tripod Used

The background color of icons is light blue when the background is a blue sky, dark blue when the background is dark, and gray for all other backgrounds.

The background color of icons is light blue when the background is a blue sky, and gray for all other backgrounds.

The background color of , , , , and is dark blue, and the background color of is orange.

Still Images

Movies

Cover

Preliminary Notes and Legal Information

Contents: Basic Operations

Basic Guide

Advanced Guide

1 Camera Basics

2 Creative Shot Mode

3 Auto Mode/Hybrid Auto Mode

4 Other Shooting Modes

5 P Mode

6 Playback Mode

7 Wi-Fi Functions

8 Setting Menu

9 Accessories

10 Appendix

Index



- When shooting movies, only People, Other Subjects, and At Close Range icons will be displayed.
- When shooting in [A] mode, only People, Shadows on Face, Other Subjects, and At Close Range icons will be displayed.
- When shooting with the self-timer, People (In Motion), Smiling, Sleeping, Babies (Smiling), Babies (Sleeping), Children, Other Subjects (In Motion) icons will not be displayed.
- When the drive mode is set to [] (62), Smiling, Sleeping, Babies (Smiling), Babies (Sleeping), and Children icons will not be displayed.
- If the flash is set to [A], the Backlit icons for Smiling and Children will not be displayed.
- Babies, Babies (Smiling), Babies (Sleeping), and Children icons will be displayed when [Face ID] is set to [On], and the face of a registered baby (under two years old) or child (from two to twelve years old) is detected (44). Confirm beforehand that the date and time are correct (13).

- ! Try shooting in [P] mode (59) if the scene icon does not match actual shooting conditions, or if it is not possible to shoot with your expected effect, color, or brightness.

Continuous Shooting Scenes

If you shoot a still image when the following scene icons are displayed, the camera will shoot continuously. If you press the shutter ring halfway when one of the icons in the table below is displayed, one of the following icons will be displayed to inform you that the camera will shoot continuous images: [A], [A], or [A].

| | |
|-----------------------------|---|
| Smiling (including Babies) | : Consecutive images are captured, and the camera analyzes details such as facial expressions to save the image determined to be the best. |
| Sleeping (including Babies) | : Beautiful shots of sleeping faces, created by combining consecutive shots to reduce camera shake and image noise. The AF assist beam will not light up, the flash will not fire, and the shutter sound will not be played. |
| Children | : So you don't miss a photo opportunity of children who move around, the camera will capture three consecutive images for each shot. |

- ! In some scenes, expected images may not be saved, and images may not look as expected.
- Focus, image brightness, and color are determined by the first shot.
- When you want to shoot single images only, touch [FUNC.], choose [A] in the menu, and then select [].

Image Stabilization Icons

Optimal image stabilization for the shooting conditions is automatically applied (Intelligent IS). Additionally, the following icons are displayed in [AUTO] and [A] modes.

| | |
|---|---|
| Image stabilization for still images | Image stabilization for movies, reducing strong camera shake, as when shooting while walking (Dynamic IS) |
| Image stabilization for still images, when panning* | Image stabilization for slow camera shake, such as when shooting movies at telephoto (Powered IS) |
| Image stabilization for macro shots (Hybrid IS) | No image stabilization, because the camera is mounted on a tripod or held still by other means |

* Displayed when you pan, following moving subjects with the camera. When you follow subjects moving horizontally, image stabilization only counteracts vertical camera shake, and horizontal stabilization stops. Similarly, when you follow subjects moving vertically, image stabilization only counteracts horizontal camera shake.

- To cancel image stabilization, set [IS Mode] to [Off] (63). In this case, an IS icon is not displayed.
- In [A] mode, no [] icon is displayed.

Cover

Preliminary Notes and Legal Information

Contents: Basic Operations

Basic Guide

Advanced Guide

1 Camera Basics

2 Creative Shot Mode

3 Auto Mode/Hybrid Auto Mode

4 Other Shooting Modes

5 P Mode

6 Playback Mode

7 Wi-Fi Functions

8 Setting Menu

9 Accessories

10 Appendix

Index



On-Screen Frames

In [AUTO] mode, a variety of frames are displayed once the camera detects subjects you are aiming the camera at.

- A white frame is displayed around the subject (or person's face) determined by the camera to be the main subject, and gray frames are displayed around other detected faces. Frames follow moving subjects within a certain range to keep them in focus.

However, if the camera detects subject movement, only the white frame will remain on the screen.

- When you are pressing the shutter ring halfway and the camera detects subject movement, a blue frame is displayed, and the focus and image brightness are constantly adjusted (Servo AF).



- Try shooting in [P] mode (📖 59) if no frames are displayed, if frames are not displayed around desired subjects, or if frames are displayed on the background or similar areas.
- To choose subjects to focus on, touch the desired subject on the screen. [] is displayed, and the camera enters Touch AF mode (📖 43). Pressing the shutter ring halfway will display a blue AF frame, and the camera will keep the subject in focus and image brightness adjusted (Servo AF).
- Touch AF is not available when shooting movies.

Common, Convenient Features

Zooming In Closer on Subjects (Digital Zoom)

When distant subjects are too far away to enlarge using the optical zoom, use digital zoom for up to about 32x enlargement.

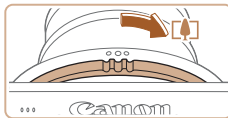

1 Turn the zoom ring.

- Turn the ring in the direction shown until zooming stops.
- ▶ Zooming stops at the largest possible zoom factor (before the image becomes noticeably grainy), which is then indicated on the screen.

2 Turn the ring in the same direction again.

- ▶ The camera zooms in even closer on the subject.





- Turning the zoom ring will display the zoom bar (which indicates the zoom position). The color of the zoom bar will change depending on the zoom range.
 - White range: optical zoom range where the image will not appear grainy.
 - Yellow range: digital zoom range where the image is not noticeably grainy (ZoomPlus).
 - Blue range: digital zoom range where the image will appear grainy. Because the blue range will not be available at some resolution settings (49), the maximum zoom factor can be achieved by following step 1.



- Focal length when optical and digital zoom are combined is as follows (35mm film equivalent).
28 – 896 mm (28 – 224 mm with optical zoom alone)

Still Images

Movies

Using the Self-Timer

With the self-timer, you can include yourself in group photos or other timed shots. The camera will shoot about 10 seconds after you press the shutter ring.

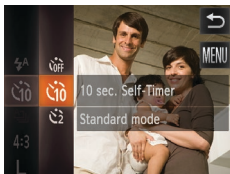

1 Configure the setting.

- Touch [FUNC.], choose [OFF] in the menu, and then choose the [10] option (42).
- ▶ Once the setting is complete, [10] is displayed.

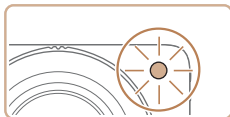

2 Shoot.

- For Still Images: Press the shutter ring halfway to focus on the subject, and then press it all the way down.
 - For Movies: Touch [●].
- ▶ Once you start the self-timer, the lamp will blink and the camera will play a self-timer sound.
 - ▶ Two seconds before the shot, the blinking and sound will speed up. (The lamp will remain lit in case the flash fires.)
 - To cancel shooting after you have triggered the self-timer, touch the screen.
 - To restore the original setting, choose [OFF] in step 1.

Still Images

Movies

Using the Self-Timer to Avoid Camera Shake

This option delays shutter release until about two seconds after you have pressed the shutter ring. If the camera is unsteady while you are pressing the shutter ring, it will not affect your shot.

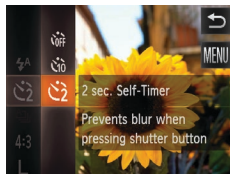

Configure the setting.

- Follow step 1 in “Using the Self-Timer” (42) and choose [2].
- ▶ Once the setting is complete, [2] is displayed.
- Follow step 2 in “Using the Self-Timer” (42) to shoot.

Cover

Preliminary Notes and
Legal InformationContents: Basic
Operations

Basic Guide

Advanced Guide

1 Camera Basics

2 Creative Shot
Mode3 Auto Mode/
Hybrid Auto Mode4 Other Shooting
Modes

5 P Mode

6 Playback Mode

7 Wi-Fi Functions

8 Setting Menu

9 Accessories

10 Appendix

Index



Shooting By Touching the Screen (Touch Shutter)

With this option, instead of pressing the shutter ring, you can simply touch the screen and release your finger to shoot. The camera will focus on subjects and adjust image brightness automatically.

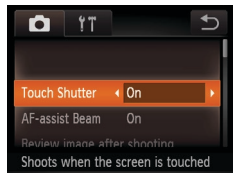

1 Enable touch-shutter function.

- Touch [FUNC.], touch [MENU], choose [Touch Shutter] on the [CAMERA] tab, and then choose [On] (📖30).

2 Choose a subject to focus on.

- Touch the subject on the screen and keep your finger on the screen.
- The camera beeps twice after focusing. A blue frame is displayed, and the camera will keep the subject in focus and image brightness adjusted (Servo AF).

3 Shoot.

- Release your finger from the screen. A shutter sound is played as the camera shoots.
- To cancel touch shutter, choose [Off] in step 1.

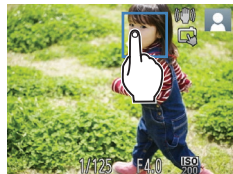

- Even while the shot is displayed, you can prepare for the next shot by touching [↵].



- In [AF-ON] mode, a green frame is displayed where you touch the screen in step 2, and the focus and brightness level will not change.

Choosing Subjects to Focus On (Touch AF)

You can shoot after the camera focuses on your selected subject, person's face, or location shown on the screen.



1 Choose a subject, a person's face, or a location to focus on.

- Touch the subject or person on the screen.

- ▶ When the subject is detected, the camera beeps and [AF-ON] is displayed. Focus is maintained even if the subject moves.
- To cancel Touch AF, touch [↵].

2 Shoot.

- Hold the shutter ring halfway down to focus on a subject. The [AF-ON] frame changes to a blue [AF-ON] frame, and the camera will keep the subject in focus and image brightness adjusted (Servo AF).
- Press the shutter ring all the way down to shoot.





- If you prefer the camera not to shoot when you touch the screen, make sure [Touch Shutter] mode is deactivated. Touch [FUNC.] and then [MENU], and on the [📷] tab, set [Touch Shutter] to [Off] (📖43).
- Tracking may not be possible when subjects are too small or move too rapidly, or when there is inadequate contrast between subjects and the background.
- If [Face ID] is set to [On], names will not display when registered people are detected, but the names will be recorded in the still images (📖44). However, a name will display if the subject chosen to focus on is the same as a person detected with Face ID.

Still Images

Movies

Deactivating the Flash

Prepare the camera for shooting without the flash as follows. Note that this setting also deactivates the flash during movie recording.

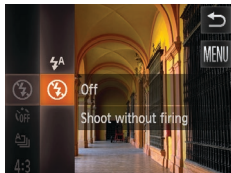

Configure the setting.

- Touch [FUNC.] and choose [⚡^A] in the menu, and then choose [🔇] (📖29).
- ▶ Once the setting is complete, [🔇] is displayed.
- To restore the original setting, repeat this process but choose [⚡^A].



- If a flashing [📷] icon is displayed when you press the shutter ring halfway in low-light conditions, mount the camera on a tripod or take other measures to keep it still.

Using Face ID

If you register a person ahead of time, the camera will detect that person's face, and prioritize focus, brightness, and color for that person when shooting. In [AUTO] mode, the camera can detect babies and children based on registered birthdays and optimize settings for them when shooting. This function is also useful when searching for a specific registered person among a large number of images (📖69).

Personal Information

- Information such as images of a face (face info) registered with Face ID, and personal information (name, birthday) will be saved on the camera. Additionally, when registered people are detected, their names will be recorded in still images. When using the Face ID function, be careful when sharing the camera or images with others, and when posting images online where many others can view them.
- When disposing of a camera or transferring it to another person after using Face ID, be sure to erase all information (registered faces, names, and birthdays) from the camera (📖48).

Registering Face ID Information

You can register information (face info, name, birthday) for up to 12 people to use with Face ID.

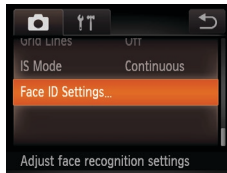

1 Access the setting screen.

- Touch [FUNC.], touch [MENU], and then touch [Face ID Settings] on the [📷] tab to choose it (📖30).

Cover

Preliminary Notes and
Legal InformationContents: Basic
Operations

Basic Guide

Advanced Guide

1 Camera Basics

2 Creative Shot
Mode3 Auto Mode/
Hybrid Auto Mode4 Other Shooting
Modes

5 P Mode

6 Playback Mode

7 Wi-Fi Functions

8 Setting Menu

9 Accessories

10 Appendix

Index



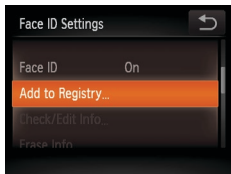

- Touch [Add to Registry].

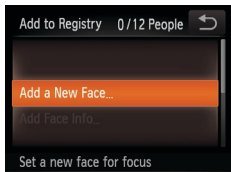

- Touch [Add a New Face].

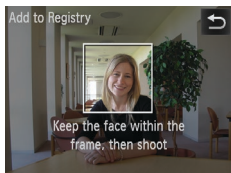

2 Register face information.

- Aim the camera so that the face of the person you want to register is inside the gray frame at the center of the screen.
- A white frame on the person's face indicates that the face is recognized. Make sure a white frame is displayed on the face, and then shoot.
- If the face is not recognized, you cannot register face information.
- After [Register?] is displayed, touch [OK].
- ▶ The [Edit Profile] screen is displayed.

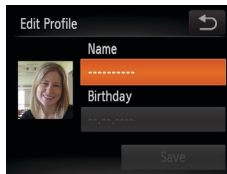
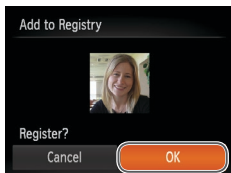

3 Register the person's name and birthday.

- Touch the name text box.



- Touch the desired character to enter it.
- Touch [⏪][⏩] to move the cursor.
- Touch [↵] to enter capital letters.
- Touch [123] to enter numbers or symbols.
- Touch [✖] to delete the previous character.
- To return to the [Edit Profile] screen, touch [↩].



- To register a birthday, on the [Edit Profile] screen, touch the birthday text box.
- Touch an item to set it.
- Touch [▲][▼] to specify the date.
- When finished, touch [↩].

| |
|---|
| Cover |
| Preliminary Notes and Legal Information |
| Contents: Basic Operations |
| Basic Guide |
| Advanced Guide |
| 1 Camera Basics |
| 2 Creative Shot Mode |
| 3 Auto Mode/Hybrid Auto Mode |
| 4 Other Shooting Modes |
| 5 P Mode |
| 6 Playback Mode |
| 7 Wi-Fi Functions |
| 8 Setting Menu |
| 9 Accessories |
| 10 Appendix |

Index



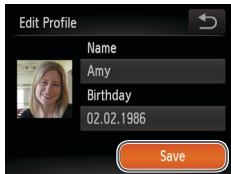

4 Save the settings.

- Touch [Save].
- After a message is displayed, touch [Yes].

5 Continue registering face information.

- To register up to 4 more points of face information (expressions or angles), repeat step 2.
- Registered faces are more easily recognized if you add a variety of face information. In addition to a head-on angle, add a slight side angle, a shot when smiling, and shots inside and outside.



- The flash will not fire when following step 2.
- If you do not register a birthday in step 3, Babies or Children icons (📖39) will not be displayed in [AUTO] mode.



- You can overwrite registered face info, and add face info later if you have not filled all 5 face info slots (📖47).



Shooting

If you register a person ahead of time, the camera will prioritize that person as the main subject, and optimize focus, brightness, and color for that person when shooting.

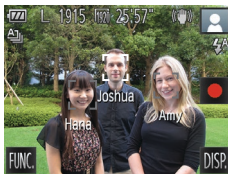

- ▶ When you point the camera toward a subject, the names of up to 3 registered people will be displayed when they are detected.
- Shoot.
- ▶ Displayed names will be recorded in still images. Even if people are detected, but their names are not displayed, the names (up to 5 people) will be recorded in the image.



- People other than those registered may be mistakenly detected as the registered person if they share similar facial features.



- In [📷] mode, names are not displayed on the screen, but they will be recorded in still images.
- Registered people may not be correctly detected if the captured image or scene differs drastically from the registered face information.
- If a registered face is not detected, or not easily detected, overwrite registered information with new face info. Registering face info right before shooting will allow for easier detection of registered faces.
- If a person is mistakenly detected as another person and you continue shooting, you can edit or erase the name recorded in the image during playback (📖70).
- Because faces of babies and children change quickly as they grow, you should update their face info regularly (📖47).
- When information display is set to off (📖29), names will not display, but will be recorded in the image.
- If you don't want names to be recorded in still images, choose [Face ID Settings] on the [📷] tab, choose [Face ID], and then choose [Off].
- You can check names recorded in images in the playback screen (simple information display) (📖65).

Cover

Preliminary Notes and Legal Information

Contents: Basic Operations

Basic Guide

Advanced Guide

1 Camera Basics

2 Creative Shot Mode

3 Auto Mode/Hybrid Auto Mode

4 Other Shooting Modes

5 P Mode

6 Playback Mode

7 Wi-Fi Functions

8 Setting Menu

9 Accessories

10 Appendix

Index



Checking and Editing Registered Information

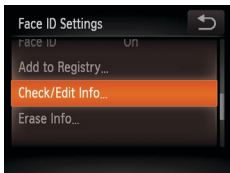

1 Access the [Check/Edit Info] screen.

- Following step 1 in “Registering Face ID Information” (📖44), touch [Check/Edit Info].

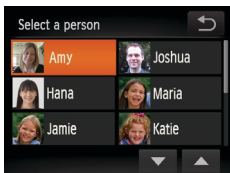

2 Choose a person to check or edit.

- Touch the image of the person you want to check or edit.

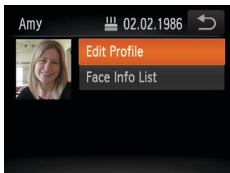

3 Check or edit the information as needed.

- To check a name or birthday, touch [Edit Profile]. On the screen displayed, you can edit names or birthdays as described in step 3 of “Registering Face ID Information” (📖45).
- To check face information, touch [Face Info List]. To erase face information, touch [Erase] on the screen displayed, and then touch the face information to erase. After [Erase?] is displayed, touch [OK].



- Even if you change names in [Edit Profile], the names recorded in previously shot images will remain the same.



- You can use the included software to edit registered names. Some characters entered with the included software may not display on the camera, but will be correctly recorded in images.

Overwriting and Adding Face Information

You can overwrite existing face information with new face info. You should update face information regularly, especially with babies and children, as their faces change quickly as they grow. You can also add face information when all 5 face info slots have not been filled.

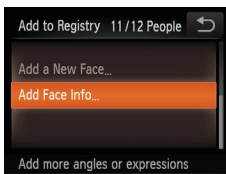

1 Access the [Add Face Info] screen.

- Following step 1 in “Registering Face ID Information” (📖44), touch [Add Face Info].

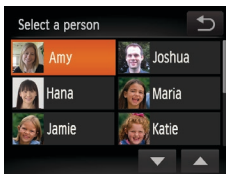

2 Choose the name of the person to overwrite.

- Touch the name of the person to overwrite.
- A message is displayed if you have already registered five faces. In this case, touch [OK].
- If less than five faces are registered, go to step 4 to add face information.

Cover

Preliminary Notes and Legal Information

Contents: Basic Operations

Basic Guide

Advanced Guide

1 Camera Basics

2 Creative Shot Mode

3 Auto Mode/ Hybrid Auto Mode

4 Other Shooting Modes

5 P Mode

6 Playback Mode

7 Wi-Fi Functions

8 Setting Menu

9 Accessories

10 Appendix

Index



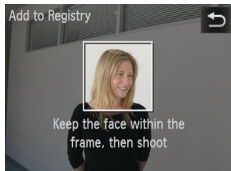
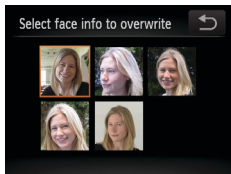

3 Choose the face info to overwrite.

- Touch the image of the face info you want to overwrite.

4 Register face information.

- Follow step 2 in “Registering Face ID Information” (📖45) to shoot, and then register the new face information.
- Registered faces are more easily recognized if you add a variety of face information. In addition to a head-on angle, add a slight side angle, a shot when smiling, and shots inside and outside.



- You cannot add face information if all 5 information slots are filled. Follow the steps above to overwrite face information.
- You can follow the above steps to register new face info when there is at least one slot open; however, you cannot overwrite any face information. Instead of overwriting face info, first erase unwanted existing info (📖48), and then register new face information (📖44) as needed.

Erasing Registered Information

You can erase information (face info, name, birthday) registered to Face ID. However, names recorded in previously shot images will not be erased.

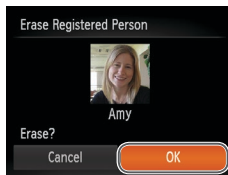
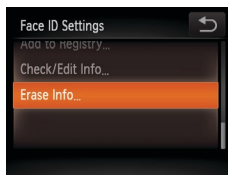

1 Access the [Erase Info] screen.

- Follow step 1 in “Registering Face ID Information” (📖44) and choose [Erase Info].

2 Choose the name of the person whose info you want to erase.

- Touch the name of the person to erase.
- After [Erase?] is displayed, touch [OK].



- If you erase a registered person's info, you will not be able to display their name (📖68), overwrite their info (📖70), or search images for them (📖69).



- You can also erase names in image information (📖70).

Cover

Preliminary Notes and Legal Information

Contents: Basic Operations

Basic Guide

Advanced Guide

1 Camera Basics

2 Creative Shot Mode

3 Auto Mode/Hybrid Auto Mode

4 Other Shooting Modes

5 P Mode

6 Playback Mode

7 Wi-Fi Functions

8 Setting Menu

9 Accessories

10 Appendix

Index

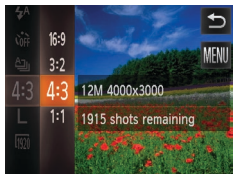

Image Customization Features

Still Images

Changing the Aspect Ratio

Change the image aspect ratio (ratio of width to height) as follows.



Configure the setting.

- Touch [FUNC.], choose [4:3] in the menu, and choose the desired option (📖29).
- ▶ Once the setting is complete, the screen aspect ratio will be updated.
- To restore the original setting, repeat this process but choose [4:3].

| | |
|------|--|
| 16:9 | Same aspect ratio as widescreen HDTVs. |
| 3:2 | Same aspect ratio as 35mm film, used for printing images at 5 x 7-inch or postcard sizes. |
| 4:3 | Native aspect ratio of the camera screen, also used for display on standard-definition televisions or similar display devices, or for printing images at 3.5 x 5-inch or A-series sizes. |
| 1:1 | Square aspect ratio. |



- Not available in [📷] mode.

Changing Image Resolution (Size)

Choose from 4 levels of image resolution, as follows. For guidelines on how many shots at each resolution setting can fit on a memory card, see “Number of 4:3 Shots per Memory Card” (📖130).

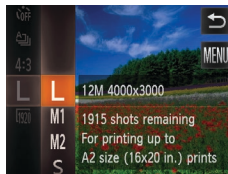

Configure the setting.

- Touch [FUNC.], choose [L] in the menu, and choose the desired option (📖29).
- ▶ The option you configured is now displayed.
- To restore the original setting, repeat this process but choose [L].

Guidelines for Choosing Resolution Based on Paper Size (for 4:3 Images)

| | |
|---------------------------------------|----|
| A2 (16.5 x 23.4 in.) | L |
| A3 – A5 (11.7 x 16.5 – 5.8 x 8.3 in.) | M1 |
| 5 x 7 in. Postcard 3.5 x 5 in. | M2 |

- [S]: For e-mailing images.

Still Images

Cover

Preliminary Notes and Legal Information

Contents: Basic Operations

Basic Guide

Advanced Guide

1 Camera Basics

2 Creative Shot Mode

3 Auto Mode/Hybrid Auto Mode

4 Other Shooting Modes

5 P Mode

6 Playback Mode

7 Wi-Fi Functions

8 Setting Menu

9 Accessories

10 Appendix

Index



Changing Movie Image Quality

3 image quality settings are available. For guidelines on the maximum movie length at each level of image quality that will fit on a memory card, see “Recording Time per Memory Card” (130).

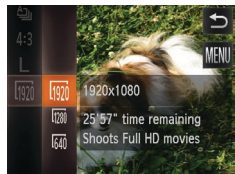

Configure the setting.

- Touch [FUNC.], choose [1920] in the menu, and choose the desired option (29).
- ▶ The option you configured is now displayed.
- To restore the original setting, repeat this process but choose [1920].

| Image Quality | Resolution | Frame Rate | Details |
|---------------|-------------|------------|-------------------------------------|
| 1920 | 1920 x 1080 | 24 fps | For shooting in Full HD |
| 1280 | 1280 x 720 | 30 fps | For shooting in HD |
| 640 | 640 x 480 | 30 fps | For shooting in standard definition |



- In [1920] and [1280] modes, black bars displayed on the top and bottom edges of the screen indicate image areas not recorded.

Helpful Shooting Features

Displaying Grid Lines

Grid lines can be displayed on the screen for vertical and horizontal reference while shooting.



Configure the setting.

- Touch [FUNC.], touch [MENU], choose [Grid Lines] on the [CAMERA] tab, and then choose [On] (30).
- ▶ Once the setting is complete, grid lines are displayed on the screen.
- To restore the original setting, repeat this process but choose [Off].



- Grid lines are not recorded in your shots.



Customizing Camera Operation

Customize shooting functions on the [CAM] tab of the menu as follows. For instructions on menu functions, see “MENU Menu” (30).

Deactivating the AF Assist Beam

You can deactivate the lamp that normally lights up to help you focus when you press the shutter ring halfway in low-light conditions.

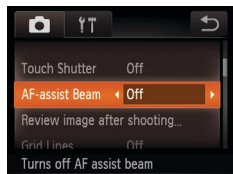

Configure the setting.

- Touch [FUNC.], touch [MENU], choose [AF-assist Beam] on the [CAM] tab, and then choose [Off] (30).
- To restore the original setting, repeat this process but choose [On].

Still Images

Changing the Image Display Style After Shots

You can change how long images are displayed and what information is displayed immediately after shooting.

Changing the Image Display Period After Shots

1 Access the [Review image after shooting] screen.

- After touching [FUNC.], touch [MENU], touch the [CAM] tab, and then touch [Review image after shooting] (30).

2 Configure the setting.

- Choose [Display Time], and then choose the desired option.
- To restore the original setting, repeat this process but choose [Quick].

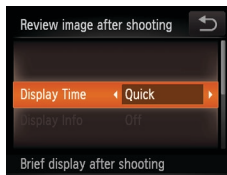

| | |
|------------------------|---|
| Quick | Displays images only until you can shoot again. |
| 2 sec., 4 sec., 8 sec. | Displays images for the specified time. Even while the shot is displayed, you can take another shot by pressing the shutter ring halfway again. |
| Hold | Displays images until you press the shutter ring halfway. |
| Off | No image display after shots. |

Still Images

Cover

Preliminary Notes and Legal Information

Contents: Basic Operations

Basic Guide

Advanced Guide

1 Camera Basics

2 Creative Shot Mode

3 Auto Mode/Hybrid Auto Mode

4 Other Shooting Modes

5 P Mode

6 Playback Mode

7 Wi-Fi Functions

8 Setting Menu

9 Accessories

10 Appendix

Index



Changing the Screen Displayed After Shots

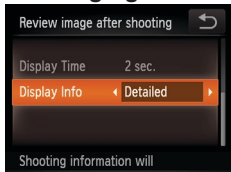

- 1 Set [Display Time] to [2 sec.], [4 sec.], [8 sec.], or [Hold] (📖 51).
- 2 Configure the setting.
 - Choose [Display Info], and then choose the desired option.
 - To restore the original setting, repeat this process but choose [Off].

| | |
|----------|------------------------------------|
| Off | Displays only the image. |
| Detailed | Displays shooting details (📖 125). |



- When [Display Time] (📖 51) is set to [Off] or [Quick], [Display Info] is set to [Off] and cannot be changed.
- By touching the screen while an image is displayed after shooting, you can switch the display information. Note that the settings of [Display Info] on the [📷] tab cannot be changed. By touching [FUNC.], you can do the following operations.
 - Erase (📖 72)
 - Favorites (📖 75)

Cover

Preliminary Notes and Legal Information

Contents: Basic Operations

Basic Guide

Advanced Guide

1 Camera Basics

2 Creative Shot Mode

3 Auto Mode/Hybrid Auto Mode

4 Other Shooting Modes

5 P Mode

6 Playback Mode

7 Wi-Fi Functions

8 Setting Menu

9 Accessories

10 Appendix

Index



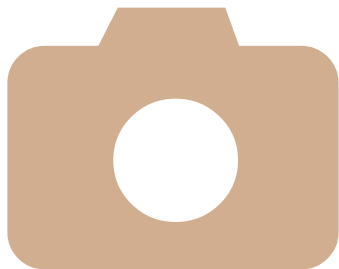

4

Other Shooting Modes

Shoot more effectively in various scenes, and take shots enhanced with unique image effects or captured using special functions

| | |
|--|----|
| Applying Special Effects | 54 |
| Shooting Super Slow Motion Movies..... | 57 |

| |
|---|
| Cover |
| Preliminary Notes and Legal Information |
| Contents: Basic Operations |
| Basic Guide |
| Advanced Guide |
| 1 Camera Basics |
| 2 Creative Shot Mode |
| 3 Auto Mode/Hybrid Auto Mode |
| 4 Other Shooting Modes |
| 5 P Mode |
| 6 Playback Mode |
| 7 Wi-Fi Functions |
| 8 Setting Menu |
| 9 Accessories |
| 10 Appendix |
| Index |



Applying Special Effects

Add a variety of effects to images when shooting.



1 Enter [CAMERA] mode.

- Set the mode switch to [CAMERA].

2 Choose a shooting mode.

- Touch [AUTO].
- To view other shooting modes, touch [◀] [▶] or quickly drag left or right on the screen.
- Touch the desired mode to view a description.
- To confirm your choice, touch [OK].
- Touch [↶] to return to the shooting mode selection screen.

3 Shoot.

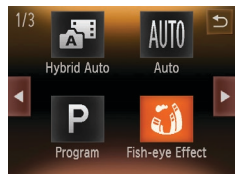

Still Images

Shooting with a Fish-Eye Lens Effect (Fish-eye Effect)

Shoot with the distorting effect of a fish-eye lens.

1 Choose [FISH-EYE].

- Follow steps 1 – 2 in “Applying Special Effects” (p. 54) and choose [FISH-EYE].

2 Choose an effect level.

- Touch [EFFECT LEVEL], touch [◀] [▶] to choose an effect level, and then touch [OK].
- ▶ A preview is shown of how your shot will look with the effect applied.

3 Shoot.

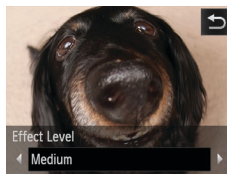

- ! Try taking some test shots first, to make sure you obtain the desired results.

Cover

Preliminary Notes and Legal Information

Contents: Basic Operations

Basic Guide

Advanced Guide

1 Camera Basics

2 Creative Shot Mode

3 Auto Mode/ Hybrid Auto Mode

4 Other Shooting Modes

5 P Mode

6 Playback Mode

7 Wi-Fi Functions

8 Setting Menu

9 Accessories

10 Appendix

Index



Shots Resembling Miniature Models (Miniature Effect)

Creates the effect of a miniature model, by blurring image areas above and below your selected area.

You can also make movies that look like scenes in miniature models by choosing the playback speed before the movie is recorded. People and objects in the scene will move quickly during playback. Note that sound is not recorded.

1 Choose [📍].

- Follow steps 1 – 2 in “Applying Special Effects” (📖 54) and choose [📍].
- A white frame is displayed, indicating the image area that will not be blurred.

2 Choose the area to keep in focus.

- To adjust the area in focus, either touch the screen or drag the white frame up or down.
- To change the size of the area in focus, touch [◀], touch [▶], [◀▶], or [◻] to choose the option, and then touch [↩].

3 For movies, choose the movie playback speed.

- Touch [10x], touch [5x], [10x], or [20x] to choose the speed, and then touch [↩].

4 Shoot.



Playback Speed and Estimated Playback Time (for One-Minute Clips)

| Speed | Playback Time |
|-------|-----------------|
| 5x | Approx. 12 sec. |
| 10x | Approx. 6 sec. |
| 20x | Approx. 3 sec. |

- ⚠ The zoom is not available when shooting movies. Be sure to set the zoom before shooting.
- Try taking some test shots first, to make sure you obtain the desired results.



- To switch the orientation of the frame to vertical, touch [📷] in step 2. Touch the screen to move the frame. To return the frame to horizontal orientation, touch [📷] again.
- Holding the camera vertically will change the orientation of the frame.
- Movie image quality is [640] at an aspect ratio of [4:3] and [720] at an aspect ratio of [16:9] (📖 49). These quality settings cannot be changed.

Cover

Preliminary Notes and Legal Information

Contents: Basic Operations

Basic Guide

Advanced Guide

1 Camera Basics

2 Creative Shot Mode

3 Auto Mode/ Hybrid Auto Mode

4 Other Shooting Modes

5 P Mode

6 Playback Mode

7 Wi-Fi Functions

8 Setting Menu

9 Accessories

10 Appendix

Index



Shooting with a Toy Camera Effect (Toy Camera Effect)

This effect makes images resemble shots from a toy camera by vignetting (darker, blurred image corners) and changing the overall color.

1 Choose [📷].

- Follow steps 1 – 2 in “Applying Special Effects” (📖 54) and choose [📷].

2 Choose a color tone.

- Touch [🎨], touch [◀▶] to choose a color tone, and then touch [↩].
- ▶ A preview is shown of how your shot will look with the effect applied.

3 Shoot.



| | |
|----------|---|
| Standard | Shots resemble toy camera images. |
| Warm | Images have a warmer tone than with [Standard]. |
| Cool | Images have a cooler tone than with [Standard]. |

- ! Try taking some test shots first, to make sure you obtain the desired results.

Shooting With a Soft Focus Effect

This function allows you to shoot images as if a soft focus filter is attached to the camera. You can adjust the effect level as desired.

1 Choose [👤].

- Follow steps 1 – 2 in “Applying Special Effects” (📖 54) and choose [👤].

2 Choose an effect level.

- Touch [📏], touch [◀▶] to choose an effect level, and then touch [↩].
- ▶ A preview is shown of how your shot will look with the effect applied.

3 Shoot.



- ! Try taking some test shots first, to make sure you obtain the desired results.



Shooting in Monochrome

Shoot images in black and white, sepia, or blue and white.

1 Choose [📷].

- Follow steps 1 – 2 in “Applying Special Effects” (📖 54) and choose [📷].

2 Choose a color tone.

- Touch [📷], touch [⏪][⏩] to choose a color tone, and then touch [↩].
- ▶ A preview is shown of how your shot will look with the effect applied.

3 Shoot.



| | |
|-------|------------------------|
| B/W | Black and white shots. |
| Sepia | Sepia tone shots. |
| Blue | Blue and white shots. |

Shooting Super Slow Motion Movies

You can shoot fast-moving subjects for playback later in slow motion. Note that sound is not recorded.

1 Choose [📷].

- Follow steps 1 – 2 in “Applying Special Effects” (📖 54) and choose [📷].

2 Choose a frame rate.

- Touch [FUNC.], choose [📷] in the menu, and choose the desired frame rate (📖 29).
- ▶ The option you configured is now displayed.

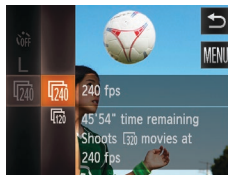

3 Shoot.

- Touch [●].
- ▶ A bar showing the elapsed time is displayed. Maximum clip length is approx. 30 sec.
- To stop movie recording, touch [■].



| Frame Rate | Image Quality | Playback Time (For a 30-sec. Clip) |
|------------|---------------|---------------------------------------|
| 📷 240 fps | 📷 (320 x 240) | Approx. 4 min. |
| 📷 120 fps | 📷 (640 x 480) | Approx. 2 min. |





- Zooming is not available during recording, even if you turn the zoom ring.
- Focus, exposure, and color are determined when you touch [●].



- When you play the movie (📖65), it will be played back in slow motion.
- You can change the playback speed of movies by using the included software. For details, refer to the *Software Guide* (📖20).

Cover

Preliminary Notes and
Legal Information

Contents: Basic
Operations

Basic Guide

Advanced Guide

1 Camera Basics

2 Creative Shot
Mode

3 Auto Mode/
Hybrid Auto Mode

4 Other Shooting
Modes

5 P Mode

6 Playback Mode

7 Wi-Fi Functions

8 Setting Menu

9 Accessories

10 Appendix

Index



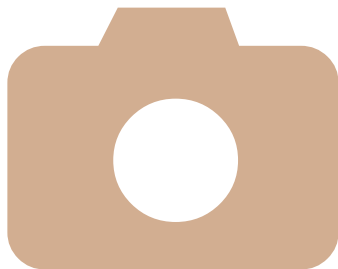

5

P Mode

More discerning shots, in your preferred shooting style

- Instructions in this chapter apply to the camera when set to **[P]** mode.
- **[P]**: Program AE; AE: Auto Exposure
- Before using a function introduced in this chapter in modes other than **[P]**, make sure the function is available in that mode (📖 126 – 127).

Shooting in Program AE ([P] Mode)60

Image Brightness (Exposure Compensation).....60

Adjusting White Balance61

Continuous Shooting.....62

Activating Flash63

Changing the IS Mode Settings.....63

| |
|---|
| Cover |
| Preliminary Notes and Legal Information |
| Contents: Basic Operations |
| Basic Guide |
| Advanced Guide |
| 1 Camera Basics |
| 2 Creative Shot Mode |
| 3 Auto Mode/Hybrid Auto Mode |
| 4 Other Shooting Modes |
| 5 P Mode |
| 6 Playback Mode |
| 7 Wi-Fi Functions |
| 8 Setting Menu |
| 9 Accessories |
| 10 Appendix |
| Index |



Shooting in Program AE ([P] Mode)

You can customize many function settings to suit your preferred shooting style.



1 Enter [P] mode.

- Follow steps 1 – 2 in “Applying Special Effects” (📖 54) and choose [P].

2 Customize the settings as desired (📖 60 – 63), and then shoot.



- If adequate exposure cannot be obtained when you press the shutter ring halfway, shutter speeds and aperture values are displayed in orange. In this case, try adjusting the ISO speed (📖 61) or activating the flash (if subjects are dark, 📖 63), which may enable adequate exposure.
- Movies can be recorded in [P] mode as well, by touching [●]. However, some [FUNC.] and [MENU] settings may be automatically adjusted for movie recording.

Image Brightness (Exposure Compensation)

Still Images

Adjusting Image Brightness (Exposure Compensation)

The standard exposure set by the camera can be adjusted in 1/3-stop increments, in a range of –2 to +2.



- Touch [FUNC.] and choose [±0] in the menu. Adjust brightness as you watch the screen (📖 29).
- ▶ The correction level you specified is now displayed.

Still Images

Changing the Metering Method

Adjust the metering method (how brightness is measured) to suit shooting conditions as follows.

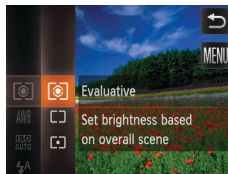

- Touch [FUNC.], choose [☉] in the menu, and choose the desired option (📖 29).
- ▶ The option you configured is now displayed.

Cover

Preliminary Notes and Legal Information

Contents: Basic Operations

Basic Guide

Advanced Guide

1 Camera Basics

2 Creative Shot Mode

3 Auto Mode/Hybrid Auto Mode

4 Other Shooting Modes

5 P Mode

6 Playback Mode

7 Wi-Fi Functions





8 Setting Menu

9 Accessories

10 Appendix

Index





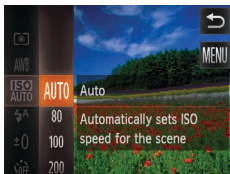

| | |
|--|---|
|  Evaluative | For typical shooting conditions, including backlit shots. Automatically adjusts exposure to match the shooting conditions. |
|  Center Weighted Avg. | Determines the average brightness of light across the entire image area, calculated by treating brightness in the central area as more important. |
|  Spot | Metering restricted to within the  (Spot AE Point frame), displayed in the center of the screen. |

Changing the ISO Speed



- Touch [FUNC.], choose  in the menu, and choose the desired option (📖29).
- ▶ The option you configured is now displayed.

| | | |
|--|---|--|
|  ISO AUTO | Automatically adjusts the ISO speed to suit the shooting mode and conditions. | |
|  80 | Low ↑ ↓ | For shooting outdoors in fair weather. |
|  100 | | For shooting in cloudy conditions, or at twilight. |
|  400 | High | For shooting night scenes, or in dark rooms. |
|  800 | | |







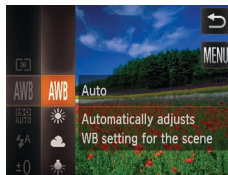

- To view the automatically set ISO speed when the camera is set to , press the shutter ring halfway.
- Although choosing a lower ISO speed may reduce image graininess, there may be a greater risk of subject blurriness in some shooting conditions.
- Choosing a higher ISO speed will increase shutter speed, which may reduce subject blurriness and increase the flash range. However, shots may look grainy.

Adjusting White Balance

By adjusting white balance (WB), you can make image colors look more natural for the scene you are shooting.



- Touch [FUNC.], choose [AWB] in the menu, and choose the desired option (📖29).
- ▶ The option you configured is now displayed.

| | | |
|---|---------------|--|
|  AWB | Auto | Automatically sets the optimal white balance for the shooting conditions. |
|  Day Light | Day Light | For shooting outdoors in fair weather. |
|  Cloudy | Cloudy | For shooting in cloudy conditions, in the shade, or at twilight. |
|  Tungsten | Tungsten | For shooting under ordinary incandescent (tungsten) lighting and similarly colored fluorescent lighting. |
|  Fluorescent | Fluorescent | For shooting under warm-white (or similarly colored) or cool-white fluorescent lighting. |
|  Fluorescent H | Fluorescent H | For shooting under daylight fluorescent and similarly colored fluorescent lighting. |



Continuous Shooting

Hold the shutter ring all the way down to shoot continuously.
For details on the continuous shooting speed, see “Continuous Shooting Speed” (📖131).

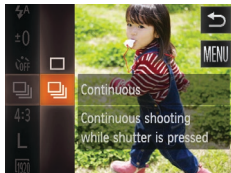

1 Configure the setting.

- Touch [FUNC.], choose [📷] in the menu, and then choose [📷] (📖29).
- ▶ Once the setting is complete, [📷] is displayed.

2 Shoot.

- ▶ Hold the shutter ring all the way down to shoot continuously.

- ❗ • Cannot be used with the self-timer (📖42).
- During continuous shooting, focus and exposure are locked at the position/level determined when you pressed the shutter ring halfway.
- Shooting may stop momentarily or continuous shooting may slow down depending on shooting conditions, camera settings, and the zoom position.
- As more shots are taken, shooting may slow down.
- Shooting may slow down if the flash fires.
- With Touch Shutter (📖43), the camera will only take one shot instead of shooting continuously.



- If you use Face ID (📖44) in [📷], the name recorded in the image will be fixed to the location where it is displayed in the first shot. Even if the subject moves, the name will stay fixed in the same position for any subsequent shots.

Cover

Preliminary Notes and Legal Information

Contents: Basic Operations

Basic Guide

Advanced Guide

1 Camera Basics

2 Creative Shot Mode

3 Auto Mode/Hybrid Auto Mode

4 Other Shooting Modes

5 P Mode

6 Playback Mode

7 Wi-Fi Functions

8 Setting Menu

9 Accessories

10 Appendix

Index



Activating Flash

You can have the flash fire for each shot. Under this setting, the flash also remains on during movie recording. For details on the flash range, see “Flash Range” (📖130).

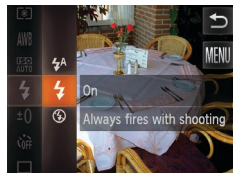

Configure the setting.

- Touch [FUNC.], choose [⚡^A] in the menu, and then choose the [⚡] option (📖29).
- ▶ Once the setting is complete, [⚡] is displayed.



- If the flash fires, vignetting may occur.

Changing the IS Mode Settings

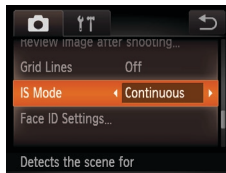

- Touch [FUNC.], touch [MENU], choose [IS Mode] on the [📷] tab, and then touch the desired option (📖30).

| | |
|-------------|--|
| Continuous | Optimal image stabilization for the shooting conditions is automatically applied (Intelligent IS) (📖40). |
| Shoot Only* | Image stabilization is active only at the moment of shooting. |
| Off | Deactivates image stabilization. |

* The setting is changed to [Continuous] for movie recording.



- If image stabilization cannot prevent camera shake, mount the camera on a tripod or take other measures to hold it still. In this case, set [IS Mode] to [Off].



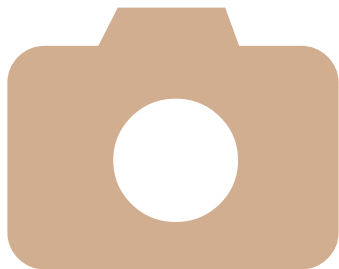

6

Playback Mode

Have fun reviewing your shots, and browse or edit them in many ways

- To prepare the camera for these operations, press the <▶> button to enter Playback mode.
- ! • It may not be possible to play back or edit images that were renamed or already edited on a computer, or images from other cameras.

| | | | |
|--|----|---|----|
| Viewing..... | 65 | Tagging Images as Favorites .. | 75 |
| Browsing and Filtering Images | 68 | Convenient Control: Touch Actions..... | 76 |
| Editing Face ID Information | 70 | Editing Still Images | 77 |
| Image Viewing Options..... | 71 | Editing Movies..... | 78 |
| Erasing Images..... | 72 | | |
| Rotating Images | 74 | | |

Cover

Preliminary Notes and
Legal Information

Contents: Basic
Operations

Basic Guide

Advanced Guide

1 Camera Basics

2 Creative Shot
Mode

3 Auto Mode/
Hybrid Auto Mode

4 Other Shooting
Modes

5 P Mode

6 Playback Mode

7 Wi-Fi Functions

8 Setting Menu

9 Accessories

10 Appendix

Index



Viewing

After shooting images or movies, you can view them on the screen as follows.

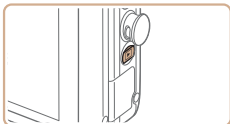

1 Enter Playback mode.

- Press the button.
- ▶ Your last shot is displayed.

2 Browse through your images.

- To view the next image, drag right to left across the screen, and to view the previous image, drag left to right.



②

①

- You can also view the next image by touching the right edge of the screen (in the area indicated by frame ① at left). In this case, is displayed. Similarly, you can view the previous image by touching the left edge of the screen (in the area indicated by frame ② at left), and in this case, is displayed.
- Touch and hold to browse through images quickly.

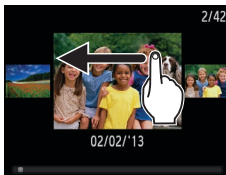

Volume

- Display will switch to Scroll Display mode if you continue scrolling.
- In this mode, scroll left or right to choose an image.
- Touching the central image will restore single-image display.
- To browse images grouped by shooting date in Scroll Display mode, scroll up or down.
- Movies are identified by a . To play movies, go to step 3.

3 Play movies.

- Touch to start playback.

4 Adjust the volume.

- Scroll up or down to adjust the volume.
- To adjust the volume when the bar is no longer displayed, quickly drag up or down across the screen.

Cover

Preliminary Notes and Legal Information

Contents: Basic Operations

Basic Guide

Advanced Guide

1 Camera Basics

2 Creative Shot Mode

3 Auto Mode/Hybrid Auto Mode

4 Other Shooting Modes

5 P Mode

6 Playback Mode

7 Wi-Fi Functions

8 Setting Menu

9 Accessories

10 Appendix

Index



5 Pause playback.

- To pause playback, touch the screen. The movie control panel is displayed. To resume playback, touch [▶].
- ▶ After the movie is finished, [⏮] is displayed.



- To switch between Shooting and Playback mode when the camera is on, press the <[▶]> button.
- To switch to Shooting mode from Playback mode when the lens is out, press the shutter ring halfway (except during battery charging (11)).
- Touching the volume indicator displays the volume panel. You can adjust the volume by touching [▲][▼].

Switching Display Modes

Touch the screen to view other information on the screen, or to hide the information. To view detailed information, hold your finger on the screen for a moment. To return to the previous display, touch the screen again. For details on the information displayed, see “Playback (Detailed Information Display)” (125).

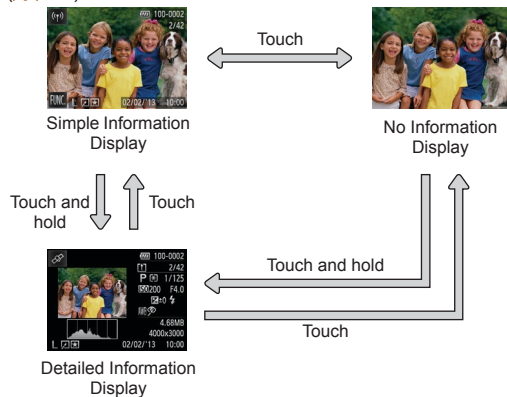

- Switching display modes is not possible while the camera is connected via Wi-Fi to devices other than printers.

Overexposure Warning (for Image Highlights)

Washed-out highlights in the image flash on the screen in detailed information display (66).

Still Images

Movies

Cover

Preliminary Notes and Legal Information

Contents: Basic Operations

Basic Guide

Advanced Guide

1 Camera Basics

2 Creative Shot Mode

3 Auto Mode/Hybrid Auto Mode

4 Other Shooting Modes

5 P Mode

6 Playback Mode

7 Wi-Fi Functions

8 Setting Menu

9 Accessories

10 Appendix

Index

Still Images

Movies



Histogram

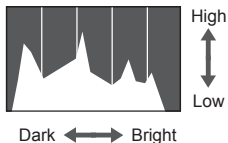

- The graph in detailed information display (📖66) is a histogram showing the distribution of brightness in the image. The horizontal axis represents the degree of brightness, and the vertical axis, how much of the image is at each level of brightness. Viewing the histogram is a way to check exposure.

GPS Information Display



- Using a smartphone connected to the camera via Wi-Fi, you can geotag images on the camera, adding information such as latitude, longitude, and elevation (📖102). Geotagged images are labeled with a [📍] icon in detailed information display. Touch the icon to view the information recorded. Latitude, longitude, elevation, and UTC (shooting date and time) are listed from top to bottom.



- [---] is shown instead of numerical values for items not available on your smartphone or items not recorded correctly.

Viewing Short Movies Created When Shooting Still Images (Digest Movies)

View digest movies recorded automatically in [📷] mode (📖38) on a day of still image shooting as follows.



1 Choose an image.

- [Play digest movie with FUNC.] is displayed in still images shot in [📷] mode.

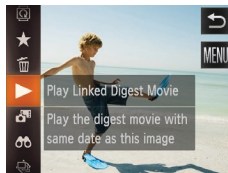

2 Play the digest movie.

- Touch [FUNC.] and choose [▶] in the menu (📖29).
 - The digest movie recorded automatically on the day of still image shooting is played back from the beginning.



- In a moment, [Play digest movie with FUNC.] will no longer be displayed.



Viewing by Date

Digest movies can be viewed by date.

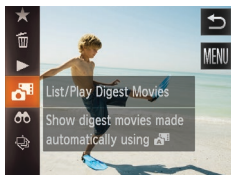

1 Choose a movie.

- Touch [FUNC.] and choose [] in the menu (29).

2 Play the movie.

- Touch the date to start movie playback.

Still Images

Checking People Detected in Face ID

If you switch the camera to simple information display mode (66), the names of up to five detected people registered in Face ID (44) will be displayed.



Switch to simple information display mode and check.

- Touch the screen until simple information display is activated, and then drag left or right across the screen to choose an image.
- Names will be displayed on detected people.



- If you do not want names to display on images shot using Face ID, touch [FUNC.], touch [MENU], choose [Face ID Info] on the [] tab, and then set [Name Display] to [Off].

Browsing and Filtering Images

Still Images

Movies

Navigating Through Images in an Index

By displaying multiple images in an index, you can quickly find the images you are looking for.



1 Display images in an index.

- Pinch in to switch from single-image display to index display.
- To view more thumbnails per screen, pinch in again.

2 Choose an image.

- Drag up or down on the screen to scroll through displayed images.
- To view fewer thumbnails per screen, spread your fingers apart.
- Touch an image to choose it, and touch it again to view it in single-image display.

Using the Zoom Ring

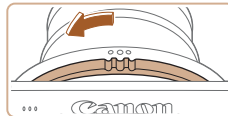

- Turn the zoom ring in the direction shown to display images in an index. Turning the ring again will increase the number of images shown.
- To display fewer images, turn the zoom ring in the opposite direction. Fewer images are shown each time you turn the ring.

Cover

Preliminary Notes and Legal Information

Contents: Basic Operations

Basic Guide

Advanced Guide

1 Camera Basics

2 Creative Shot Mode

3 Auto Mode/Hybrid Auto Mode

4 Other Shooting Modes

5 P Mode

6 Playback Mode

7 Wi-Fi Functions

8 Setting Menu

9 Accessories





10 Appendix

Index



Finding Images Matching Specified Conditions

Find desired images quickly on a memory card full of images by filtering image display according to your specified conditions.

| | |
|---|--|
|  Name | Displays images of a registered person (📖44). |
|  People | Displays images with detected faces. |
|  Shot Date | Displays the images shot on a specific date. |
|  Favorites | Displays images tagged as favorites (📖75). |
|  Still image/Movie | Displays still images, movies, or movies shot in [A] mode (📖38). |

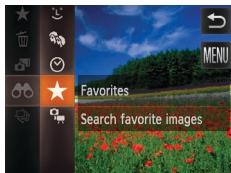

1 Choose a search condition.

- Touch [FUNC.], choose [👤] in the menu, and then choose a condition (📖29).
- When selecting [👤], [🕒], or [📷], touch the condition on the screen displayed next.

2 View the filtered images.

- Images matching your conditions are displayed in yellow frames. To view only these images, drag left or right across the screen.
- To cancel filtered display, choose [👤] in step 1.



- When the camera has found no corresponding images for some conditions, those conditions will not be available. Note that [👤] is not available unless people are registered (📖44).



- Options for viewing the images found (in step 2) include "Navigating Through Images in an Index" (📖68), "Viewing Slideshows" (📖72), and "Magnifying Images" (📖71). You can erase all images found or add them to a photobook by choosing [Select All Images in Search] in "Erasing All Images" (📖73) or "Adding Images to a Photobook" (📖116).
- If you edit images and save them as new images (📖77), a message is displayed, and the images that were found are no longer shown.

Cover

Preliminary Notes and Legal Information

Contents: Basic Operations

Basic Guide

Advanced Guide

1 Camera Basics

2 Creative Shot Mode

3 Auto Mode/ Hybrid Auto Mode

4 Other Shooting Modes

5 P Mode

6 Playback Mode

7 Wi-Fi Functions

8 Setting Menu

9 Accessories

10 Appendix

Index



Editing Face ID Information

If you notice that a name is incorrect during playback, you can change it or erase it.

However, you cannot add names for people who are not detected by Face ID (names are not displayed), and for people whose names have been erased.

Changing Names

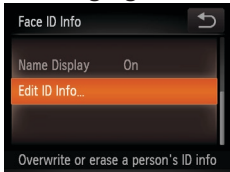

1 Access the setting screen.

- Touch [FUNC.], touch [MENU], and choose [Face ID Info] on the [▶] tab (📖30).
- Touch [Edit ID Info].

2 Choose an image.

- Choose an image after dragging left or right to browse. Touch [OK].
- To choose the name you want to overwrite, touch that person's face.



3 Choose the item to edit.

- Touch [Overwrite].

4 Choose the name of the person to overwrite.

- Touch the name of the person to overwrite.

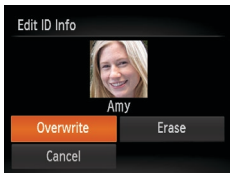

Erasing Names

- Following step 3 in “Changing Names” (📖70), touch [Erase].
- After [Erase?] is displayed, touch [OK].

Cover

Preliminary Notes and Legal Information

Contents: Basic Operations

Basic Guide

Advanced Guide

1 Camera Basics

2 Creative Shot Mode

3 Auto Mode/Hybrid Auto Mode

4 Other Shooting Modes

5 P Mode

6 Playback Mode

7 Wi-Fi Functions

8 Setting Menu

9 Accessories

10 Appendix

Index



Image Viewing Options

Still Images

Magnifying Images



1 Magnify an image.

- Spread your fingers apart (pinch out) to zoom in.
- You can magnify images up to about 10x by repeating this action.



- Pinch in to zoom out.



2 Move the display position and switch images as needed.

- To move the display position, drag across the screen.
- Touch [↶] to restore single-image display.

Approximate Position
of Displayed Area

Double-Touch Magnification



- Quickly touch the screen twice to magnify the image about 3x.
- To return to single-image display from magnified display, quickly touch the screen twice.

Using the Zoom Ring

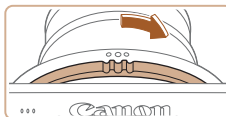

- You can also zoom in by turning the zoom ring in the direction shown, and you can magnify images up to about 10x by continuing to hold the zoom ring.
- To zoom out, turn the zoom ring in the opposite direction. You can return to single-image display by continuing to hold it.

Cover

Preliminary Notes and
Legal Information

Contents: Basic
Operations

Basic Guide

Advanced Guide

1 Camera Basics

2 Creative Shot
Mode

3 Auto Mode/
Hybrid Auto Mode

4 Other Shooting
Modes

5 P Mode

6 Playback Mode

7 Wi-Fi Functions

8 Setting Menu

9 Accessories

10 Appendix

Index



Viewing Slideshows

Automatically play back images from a memory card as follows. Each image is displayed for about three seconds.



Start a slideshow.

- Touch [FUNC.] and choose [] in the menu (29).
- ▶ The slideshow will start a few seconds after [Loading image] is displayed.
- To end the slideshow, touch the screen.



- Slideshows are played repeatedly.
- The camera's power-saving functions (26) are deactivated during slideshows.



- In image search mode (69), only images matching search conditions are played.
- Slideshows can also be started by using Touch Actions (76).

Erasing Images

You can choose and erase unneeded images one by one. Be careful when erasing images, because they cannot be recovered.

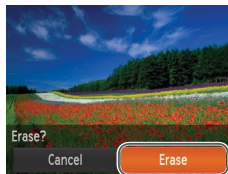

- Images can also be erased by using Touch Actions (76).

1 Choose an image to erase.

- Drag left or right across the screen to choose an image.

2 Erase the image.

- Touch [FUNC.] and choose [] in the menu (29).
- After [Erase?] is displayed, touch [Erase].
- ▶ The current image is now erased.
- To cancel erasure, touch [Cancel].



Erasing All Images

You can erase all images at once. Be careful when erasing images, because they cannot be recovered.

Choosing a Selection Method

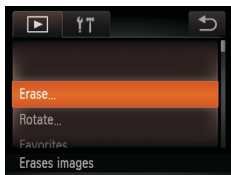

1 Access the setting screen.

- Touch [FUNC.], touch [MENU], and choose [Erase] on the [▶] tab (📖30).

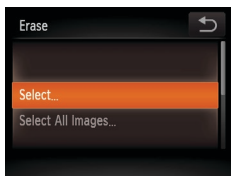

2 Choose a selection method.

- Choose a setting as desired (📖30).
- Touch [↩] to return to the menu screen.



2 Choose an image.

- Choose an image after dragging left or right to browse. Once you touch the screen, [✓] is displayed.
- To cancel selection, touch the screen again. [✓] is no longer displayed.
- Repeat this process to specify other images.
- Touch [OK]. A confirmation message is displayed.

3 Erase the image.

- Touch [OK].

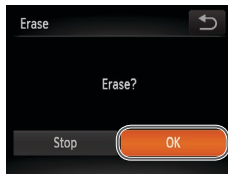

Choosing Images Individually

1 Choose [Select].

- Following step 2 in “Choosing a Selection Method” (📖73), touch [Select].

Specifying All Images at Once

1 Choose [Select All Images].

- Following step 2 in “Choosing a Selection Method” (📖73), touch [Select All Images].

2 Erase the images.

- Touch [OK].

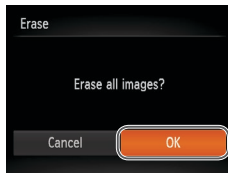

Cover

Preliminary Notes and
Legal Information

Contents: Basic
Operations

Basic Guide

Advanced Guide

1 Camera Basics

2 Creative Shot
Mode

3 Auto Mode/
Hybrid Auto Mode

4 Other Shooting
Modes

5 P Mode

6 Playback Mode

7 Wi-Fi Functions

8 Setting Menu

9 Accessories

10 Appendix

Index



Rotating Images

Change the orientation of images and save them as follows.

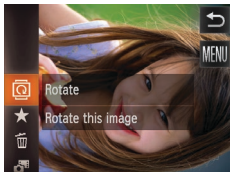

1 Choose [Rotate].

- Touch [FUNC.] and choose [Rotate] in the menu (📖 29).

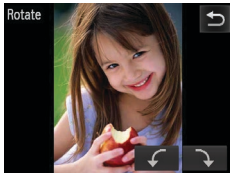

2 Rotate the image.

- Touch [↶] or [↷], depending on the desired direction. Each time you touch, the image is rotated 90°. Touch [↵] to complete the setting.

- ⚠ Movies with an image quality of [F1920] or [F1280] cannot be rotated.
- Rotation is not possible when [Auto Rotate] is set to [Off] (📖 74).

Using the Menu

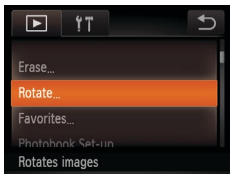

1 Choose [Rotate].

- Touch [FUNC.] and then [MENU], and then choose [Rotate] on the [▶] tab (📖 30).

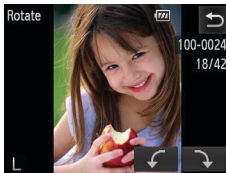

2 Rotate the image.

- Drag left or right across the screen to choose an image.
- Touch [↶] or [↷], depending on the desired direction. Each time you touch, the image is rotated 90°.
- To rotate other images, repeat step 2.
- Touch [↵] to return to the menu screen.

Deactivating Auto Rotation

Follow these steps to deactivate automatic rotation by the camera, which rotates images shot in vertical orientation so they are displayed vertically on the camera.

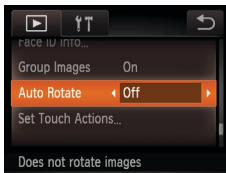

- Touch [FUNC.], touch [MENU], choose [Auto Rotate] on the [▶] tab, and then choose [Off] (📖 30).

- ⚠ Images cannot be rotated (📖 74) when you set [Auto Rotate] to [Off]. Additionally, images already rotated will be displayed in the original orientation.



Tagging Images as Favorites

You can organize images by tagging them as favorites. By choosing a category in filtered playback, you can restrict the following operations to all of those images.

- Viewing (📖 65), Viewing Slideshows (📖 72), Erasing Images (📖 72), Adding Images to a Photobook (📖 116)

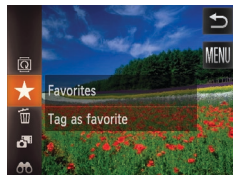

- Touch [FUNC.] and choose [★] in the menu.
- [Tagged as Favorite] is displayed.
- To untag the image, repeat this process and choose [★] again.

Using the Menu

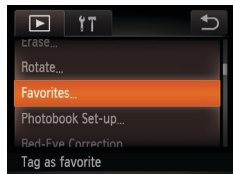

1 Choose [Favorites].

- Touch [FUNC.] and then [MENU], and then choose [Favorites] on the [▶] tab (📖 30).

2 Choose an image.

- Choose an image after dragging left or right to browse. Once you touch the screen, [✓] is displayed.
- To untag the image, touch the screen again. [✓] is no longer displayed.

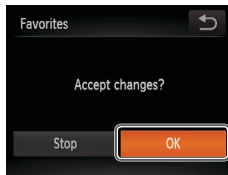

- Repeat this process to choose additional images.
- Touch [OK]. A confirmation message is displayed.

3 Finish the setup process.

- Touch [OK].



- Images will not be tagged as favorites if you switch to Shooting mode or turn the camera off before finishing the setup process in step 3.



- Favorite images will have a three-star rating (★★★☆☆) when transferred to computers running Windows 8, Windows 7, or Windows Vista. (Does not apply to movies.)
- Images can also be tagged as favorites by using Touch Actions (📖 76).

Cover

Preliminary Notes and
Legal InformationContents: Basic
Operations

Basic Guide

Advanced Guide

1 Camera Basics

2 Creative Shot
Mode3 Auto Mode/
Hybrid Auto Mode4 Other Shooting
Modes

5 P Mode

6 Playback Mode

7 Wi-Fi Functions

8 Setting Menu

9 Accessories

10 Appendix

Index



Convenient Control: Touch Actions

You can quickly and easily activate functions that you have assigned to four touch gestures (Touch Actions), in single-image display.

Using a Function Assigned to [←]

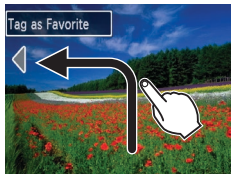

- Drag across the screen as shown.
- ▶ The function assigned to [←] is now activated.

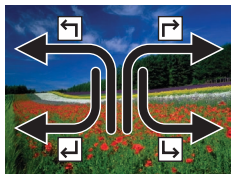

- Similarly, you can also activate functions assigned to [→], [↶], and [↷] by dragging across the screen.
- Customize functions assigned to Touch Actions as desired.

Changing Touch Actions Functions

Simplify your preferred camera operations by reassigning dragging patterns to them as desired.

1 Access the setting screen.

- Touch [FUNC.], touch [MENU], and choose [Set Touch Actions] on the [▶] tab (📖30).

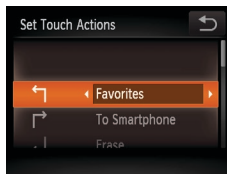

2 Assign a function to a dragging pattern.

- Drag up or down across the screen to choose a dragging pattern.
- Touch [◀][▶] to choose a function to assign.

Assignable Functions

| | |
|-------------------|---|
| Favorites | Tag images as favorites, or untag the image. |
| Next Favorite | Switch to displaying the next image tagged as a favorite. |
| Previous Favorite | Switch to displaying the previous image tagged as a favorite. |
| Next Date | Switch to displaying the first image with the next shooting date. |
| Previous Date | Switch to displaying the first image with the previous shooting date. |
| To Camera | |
| To Smartphone | |
| To Computer | Access the Wi-Fi menu. |
| To Printer | For Wi-Fi details, see "Wi-Fi Functions" (📖80). |
| To Web Service | |
| Slideshow | Start a slideshow. |
| Erase | Erase an image. |
| Rotate | Rotate an image. |

Cover

Preliminary Notes and Legal Information

Contents: Basic Operations

Basic Guide

Advanced Guide

1 Camera Basics

2 Creative Shot Mode

3 Auto Mode/Hybrid Auto Mode

4 Other Shooting Modes

5 P Mode

6 Playback Mode

7 Wi-Fi Functions

8 Setting Menu

9 Accessories

10 Appendix

Index



Editing Still Images

- Image editing (📖 77) is only available when the memory card has sufficient free space.

Correcting Red-Eye

Automatically corrects images affected by red-eye. You can save the corrected image as a separate file.

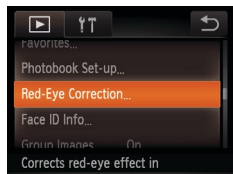

1 Choose [Red-Eye Correction].

- Touch [FUNC.], touch [MENU], and choose [Red-Eye Correction] on the [▶] tab (📖 30).

2 Choose an image.

- Drag left or right across the screen to choose an image.

3 Correct the image.

- Touch [OK].
 - ▶ Red-eye detected by the camera is now corrected, and frames are displayed around corrected image areas.
- Enlarge or reduce images as needed. Follow the steps in “Magnifying Images” (📖 71).

Still Images

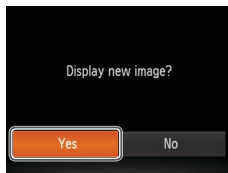

4 Save as a new image and review.

- Touch [New File].
 - ▶ The image is now saved as a new file.

5 Review the new image.

- Touch [↶]. [Display new image?] is displayed.
- Touch [Yes].
 - ▶ The saved image is now displayed.

- Some images may not be corrected accurately.
- To overwrite the original image with the corrected image, choose [Overwrite] in step 4. In this case, the original image will be erased.

Cover

Preliminary Notes and Legal Information

Contents: Basic Operations

Basic Guide

Advanced Guide

1 Camera Basics

2 Creative Shot Mode

3 Auto Mode/ Hybrid Auto Mode

4 Other Shooting Modes

5 P Mode

6 Playback Mode

7 Wi-Fi Functions

8 Setting Menu

9 Accessories

10 Appendix

Index



Editing Movies

You can cut movies to remove unneeded portions at the beginning or end.

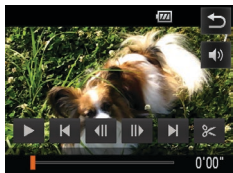

1 Specify portions to cut.

- Touch the screen during movie playback to access the movie control panel.
- Touch [◀||], [||▶], or the scroll bar to display the trimming point.
- ▶ [◻◻] changes to [◻⇒] to indicate that you can trim from the current frame.

2 Touch [◻⇒] or [◻◻].

- ▶ [Delete section of movie] is displayed.
- Touching [◻◻] when it is displayed will only trim from the nearest [◻⇒] to the beginning when you chose [Cut Beginning] or from the nearest [◻⇒] to the end when you chose [Cut End].

3 Specify which portion to remove.

- Touch [Cut Beginning] or [Cut End].
- [Cut Beginning] removes the beginning of the movie, up to the current scene.
- [Cut End] removes the end of the movie, after the current scene.

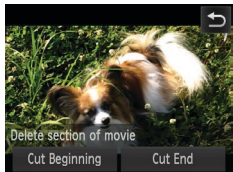

4 Save the edited movie.

- Touch [New File].
- ▶ The movie is now saved as a new file.
- To cancel trimming, touch [Cancel].
- To clear your trimming points and try again, touch [↶].



- To overwrite the original movie with the cut one, choose [Overwrite] in step 4. In this case, the original movie will be erased.
- [Overwrite] is only available when memory cards lack sufficient free space.
- Movies may not be saved if the battery runs out while saving is in progress.
- When editing movies, you should use a fully charged battery or an AC adapter kit (sold separately, 112).

Cover

Preliminary Notes and
Legal InformationContents: Basic
Operations

Basic Guide

Advanced Guide

1 Camera Basics

2 Creative Shot
Mode3 Auto Mode/
Hybrid Auto Mode4 Other Shooting
Modes

5 P Mode

6 Playback Mode

7 Wi-Fi Functions

8 Setting Menu

9 Accessories

10 Appendix

Index



Editing Digest Movies

Individual chapters (📖38) recorded in [📹] mode can be erased, as needed. Be careful when erasing chapters, because they cannot be recovered.

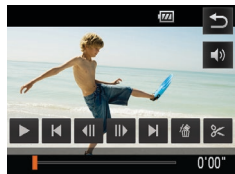

1 Select the chapter to erase.

- Follow steps 1 – 2 in “Viewing Short Movies Created When Shooting Still Images (Digest Movies)” (📖67) to play a movie created in [📹] mode, and then touch the screen to access the movie control panel.
- Touch [⏮] or [⏭] to choose a chapter.

2 Touch [🗑️].

- ▶ The selected chapter is played back repeatedly.

3 Confirm erasure.

- Touch [OK].
- ▶ The chapter is erased, and the clip is overwritten.

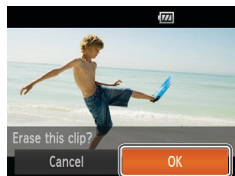

- [🗑️] is not displayed if you select a chapter when the camera is connected to a printer.

Cover

Preliminary Notes and
Legal InformationContents: Basic
Operations

Basic Guide

Advanced Guide

1 Camera Basics

2 Creative Shot
Mode3 Auto Mode/
Hybrid Auto Mode4 Other Shooting
Modes

5 P Mode

6 Playback Mode

7 Wi-Fi Functions

8 Setting Menu

9 Accessories

10 Appendix

Index



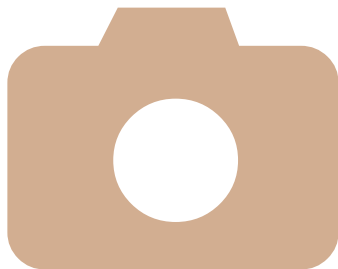

7

Wi-Fi Functions

Use Wi-Fi functions to send images from the camera to a variety of compatible devices, and use the camera with Web services

| | |
|--|---|
| What You Can Do With Wi-Fi...81 | Connecting to Another Camera.....91 |
| Using Wi-Fi to Send Images From the Camera82 | Connecting to a Computer92 |
| Wi-Fi (Wireless LAN) Precautions83 | Connecting to a Printer98 |
| Security Precautions84 | Sending Images.....99 |
| Glossary.....84 | Sending Images to a Computer via CANON IMAGE GATEWAY101 |
| Connecting to a Smartphone...85 | Geotagging Images on the Camera.....102 |
| Accessing the Wi-Fi Menu.....88 | Editing or Erasing Wi-Fi Settings.....102 |
| Connecting to Web Services...89 | |

| |
|---|
| Cover |
| Preliminary Notes and Legal Information |
| Contents: Basic Operations |
| Basic Guide |
| Advanced Guide |
| 1 Camera Basics |
| 2 Creative Shot Mode |
| 3 Auto Mode/Hybrid Auto Mode |
| 4 Other Shooting Modes |
| 5 P Mode |
| 6 Playback Mode |
| 7 Wi-Fi Functions |
| 8 Setting Menu |
| 9 Accessories |
| 10 Appendix |
| Index |



What You Can Do With Wi-Fi

This camera is an approved Wi-Fi®* product. You can wirelessly connect to and send images to the following devices.

Note that, in this chapter, wireless LAN functions other than Wi-Fi may be referred to as Wi-Fi.

* Wi-Fi is a brand name that indicates interoperability certification of Wi-Fi devices.



Connecting to a Smartphone

Simply press the  button to connect via Wi-Fi to Wi-Fi-equipped smartphones and tablet computers registered on the camera. On connected devices, you can view and save images from the camera. You can also geotag your shots from a connected smartphone or tablet. Installation of a dedicated application on the smartphone or tablet is required. See the Canon website for details.

For convenience in this manual, smartphones and tablets are collectively referred to as *smartphones*.



Connecting to Web Services

CANON IMAGE GATEWAY is an online photo service available to those who have purchased this product. If you register for free as a member, you can use CANON IMAGE GATEWAY to access various Web services, such as social networking services set on a computer. Images on the camera can also be sent automatically to a computer via CANON IMAGE GATEWAY.



Connecting to Another Camera

Use the Wi-Fi function to send images between Canon-brand, compact digital cameras.



Connecting to a Computer

Use the included software to wirelessly send images from the camera to a computer. Refer to the *Software Guide* for details.



Connecting to a Printer

Send images wirelessly to a PictBridge-compatible printer (supporting DPS over IP) to print them.

Cover

Preliminary Notes and
Legal Information

Contents: Basic
Operations

Basic Guide

Advanced Guide

1 Camera Basics

2 Creative Shot
Mode

3 Auto Mode/
Hybrid Auto Mode

4 Other Shooting
Modes

5 P Mode

6 Playback Mode

7 Wi-Fi Functions

8 Setting Menu

9 Accessories



10 Appendix

Index



Using Wi-Fi to Send Images From the Camera















Via a Smartphone Connection

After installing CameraWindow on the smartphone, press the  button on the camera to connect to the smartphone. You can then use the smartphone to acquire camera images (85).



- You can also register smartphones by accessing the Wi-Fi menu (87).

Via a Connection to Other Devices or Web Services

| | | Device |  |  |  |  |
|-------------------|--|--------|--|--|--|--|
| Preparations | Operation | | | | | |
| | Registering a camera nickname ( 88) | | ○ | ○ | ○ | ○ |
| | Installing the included software ( 19)*1 | | ○ | — | ○ | — |
| Connection | Adjusting settings for using Web services from CANON iMAGE GATEWAY ( 89) | | ○ | — | — | — |
| | Establishing a connection with the camera | | ○ ( 89) | ○ ( 91) | ○ ( 92) | ○ ( 98) |
| | Sending images ( 99) | | ○*2 | ○ | — | — |
| Send/Print/Import | Transferring images to a computer ( 97) | | — | — | ○ | — |
| | Printing images ( 98)*3 | | — | — | — | ○ |

*1 Instructions in this guide apply when the software has been installed correctly from the included CD-ROM (19).

*2 Images are sent automatically when transferred via a server (101).

*3 For detailed printing instructions, see “Printing Images” (115).

| |
|---|
| Cover |
| Preliminary Notes and Legal Information |
| Contents: Basic Operations |
| Basic Guide |
| Advanced Guide |
| 1 Camera Basics |
| 2 Creative Shot Mode |
| 3 Auto Mode/Hybrid Auto Mode |
| 4 Other Shooting Modes |
| 5 P Mode |
| 6 Playback Mode |
| 7 Wi-Fi Functions |
| 8 Setting Menu |
| 9 Accessories |
| 10 Appendix |
| Index |



Wi-Fi (Wireless LAN) Precautions

- The model number is PC1864 or PC2004 (including WLAN module model WM219). To identify your model, check the label on the back of the camera body (behind the monitor) for a number beginning with **PC**.
- Countries and Regions Permitting WLAN Use
 - Use of WLAN is restricted in some countries and regions, and illegal use may be punishable under national or local regulations. To avoid violating WLAN regulations, visit the Canon website to check where use is allowed. Note that Canon cannot be held liable for any problems arising from WLAN use in other countries and regions.
- Doing any of the following may incur legal penalties:
 - Altering or modifying the product
 - Removing the certification labels from the product
- According to foreign exchange and foreign trade law regulations, export permission (or service transaction permission) from the Japanese government is necessary to export strategic resources or services (including this product) outside Japan.
- Because this product includes American encryption software, it falls under U.S. Export Administration Regulations, and cannot be exported to or brought into a country under U.S. trade embargo.
- Be sure to make notes of the wireless LAN settings you use.

The wireless LAN settings saved to this product may be erased due to incorrect operation of the product, the effects of radio waves or static electricity, accident or malfunction. Be sure to make notes of wireless LAN settings as a precaution. Please note that Canon accepts no responsibility for degradation of content, direct or indirect damages or loss of revenue arising from use of the product.

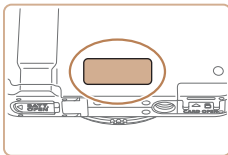

- When transferring this product to another person, disposing of it, or sending it for repair, be sure to note the wireless LAN settings and reset the product to its default settings (erase settings) if necessary.
- Canon will not make compensation for loss or theft of the product. Canon accepts no responsibility for damages incurred due to unauthorized access to registered data (image transfer destinations, etc.) if the product is lost or stolen.
- Be sure to use the product as directed in this guide.

Be sure to use the wireless LAN function of this product within the guidelines noted in this guide. Canon accepts no responsibility for damages or loss if the function and product are used in ways other than as described in this guide.
- Do not use the wireless LAN function of this product near medical equipment or other electronic equipment.

Use of the wireless LAN function near medical equipment or other electronic equipment may affect operation of those devices.

Radio Wave Interference Precautions

- This product may receive interference from other devices that emit radio waves. To avoid interference, be sure to use this product as far away as possible from such devices, or avoid using the devices at the same time as this product.

Cover

Preliminary Notes and Legal Information

Contents: Basic Operations

Basic Guide

Advanced Guide

1 Camera Basics

2 Creative Shot Mode

3 Auto Mode/ Hybrid Auto Mode

4 Other Shooting Modes

5 P Mode

6 Playback Mode

7 Wi-Fi Functions

8 Setting Menu

9 Accessories

10 Appendix

Index



Security Precautions

Because Wi-Fi uses radio waves to transmit signals, security precautions more stringent than when using a LAN cable are required.

Keep the following points in mind when using Wi-Fi.

- Only use networks you are authorized to use.

This product searches for Wi-Fi networks in the vicinity and displays the results on the screen. Networks you are not authorized to use (unknown networks) may also be displayed. However, attempting to connect to or using such networks could be regarded as unauthorized access. Be sure to use only networks you are authorized to use, and do not attempt to connect to other unknown networks.

If security settings have not been properly set, the following problems may occur.

- Transmission monitoring

Third parties with malicious intent may monitor Wi-Fi transmissions and attempt to acquire the data you are sending.

- Unauthorized network access

Third parties with malicious intent may gain unauthorized access to the network you are using to steal, modify, or destroy information. Additionally, you could fall victim to other types of unauthorized access such as impersonation (where someone assumes an identity to gain access to unauthorized information) or springboard attacks (where someone gains unauthorized access to your network as a springboard to cover their tracks when infiltrating other systems).

To prevent these types of problems from occurring, be sure to thoroughly secure your Wi-Fi network.

Only use this camera's Wi-Fi function with a proper understanding of Wi-Fi security, and balance risk and convenience when adjusting security settings.

Glossary

Wi-Fi related terms are explained here. Also refer to the explanations of terms given in the respective sections of this guide.

- Access point

A device that relays radio wave signals to create a Wi-Fi network. This term also refers to a network that you can use to connect to the Internet via Wi-Fi.

- Firewall

This is a system that protects networks from computer viruses, external unauthorized access, and security threats. This is set on the Wi-Fi router or computer.

- SSID/ESSID

Preconfigured numbers and letters used to identify a specific access point. Also called the "access point name" or "network name".

- Encryption key

This is a key used to encrypt data for transmission to and from an access point.

- IP address

This is an address used to identify a device within a network.

- MAC address

This is a unique address pre-assigned to a network device. It is also referred to as a "physical address".

Cover

Preliminary Notes and
Legal Information

Contents: Basic
Operations

Basic Guide

Advanced Guide

1 Camera Basics

2 Creative Shot
Mode

3 Auto Mode/
Hybrid Auto Mode

4 Other Shooting
Modes

5 P Mode

6 Playback Mode

7 Wi-Fi Functions

8 Setting Menu

9 Accessories

10 Appendix

Index





The camera can print to PictBridge-compatible printers via Wi-Fi. PictBridge technical standards make it easy to connect digital cameras, printers, and other devices directly. Additionally, a new standard called DPS over IP enables PictBridge connections in network environments, and the camera is also compatible with this standard.

Connecting to a Smartphone

Once you have connected to a smartphone initially via Wi-Fi by pressing the button, you can simply press the button after that to connect again and view and save camera images on connected devices.

Installing CameraWindow on a Smartphone

Before connecting your camera to a smartphone, first install the free dedicated application, CameraWindow, on your smartphone.



1 Connect the smartphone to a network.



2 Install CameraWindow.

- For an iPhone, iPad, or iPod touch, download and install CameraWindow from the Mac App Store.
- For an Android device, download and install CameraWindow from Google Play.



3 Register the smartphone name.

- On the smartphone, start CameraWindow and enter a name for the smartphone that will be displayed on the camera.



- For details on this application (supported smartphones and included functions), refer to the Canon website.

Cover

Preliminary Notes and Legal Information

Contents: Basic Operations

Basic Guide

Advanced Guide

1 Camera Basics

2 Creative Shot Mode

3 Auto Mode/Hybrid Auto Mode

4 Other Shooting Modes

5 P Mode

6 Playback Mode

7 Wi-Fi Functions

8 Setting Menu

9 Accessories

10 Appendix

Index



Establishing the Smartphone Connection

When establishing a Wi-Fi connection with a smartphone, you can either use the camera as an access point or use another access point. Follow these instructions when using the camera as an access point. When using another access point, see “Connecting to Access Points in the List” (p.96).

Note that only one smartphone can be assigned to the  button.

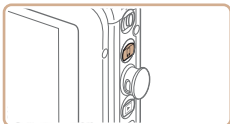

1 Press the button.

2 Register a nickname.

- Touch inside the frame shown at left to display the keyboard. Enter a nickname (p.88). (This nickname is displayed on the screen of target devices.)
- Up to 16 characters can be used.

3 Confirm the details, and touch [OK].

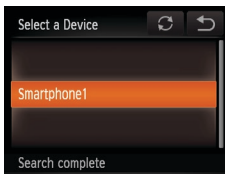
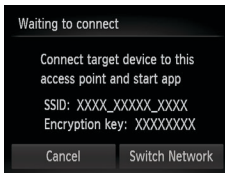
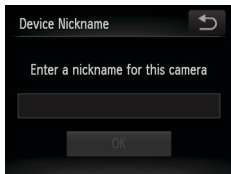

- ▶ The camera's SSID and encryption key are displayed on the screen.

4 Use the smartphone to connect to the network displayed on the camera screen.

- Choose the displayed SSID (network name) from the smartphone's Wi-Fi setting menu.
- Enter the encryption key displayed on the camera screen into the password field on the smartphone.

5 Start CameraWindow on the smartphone.

- ▶ Once the smartphone is recognized on the camera, the device connection screen will be displayed on the camera.

6 Choose a smartphone to connect to.

- Touch the name of the smartphone you want to connect to.

| |
|---|
| Cover |
| Preliminary Notes and Legal Information |
| Contents: Basic Operations |
| Basic Guide |
| Advanced Guide |
| 1 Camera Basics |
| 2 Creative Shot Mode |
| 3 Auto Mode/Hybrid Auto Mode |
| 4 Other Shooting Modes |
| 5 P Mode |
| 6 Playback Mode |
| 7 Wi-Fi Functions |
| 8 Setting Menu |
| 9 Accessories |
| 10 Appendix |
| Index |





- ▶ After a connection is established with the smartphone, the smartphone name is displayed on the camera. (This screen will close in about one minute.)

7 Import images.

- Use the smartphone to import images from the camera to the smartphone.
- Use the smartphone to end the connection; the camera will automatically turn off.



- When you are in the vicinity of an access point that you have previously connected to, the camera will automatically connect to it in step 3. To change access points, select [Switch Network] from the screen that will be displayed when the connection is being established, and follow steps 4 – 6 in “Adding a Computer” (89).



- To control the camera manually, either end the connection from the smartphone or restart the camera after pressing the ON/OFF button to turn it off momentarily.
- Once a connection has been established with a smartphone, you can automatically reconnect to the registered device by simply pressing the button, even if the camera has been turned off.
- The image quality level for movies that can be sent may differ depending on the smartphone. Refer to the instruction manual provided with your smartphone for details.
- To remove a registered smartphone, touch [FUNC.] and then [MENU], and on the [↑] tab, choose [Mobile Device Connect Button]. After the confirmation message, touch [OK].
- If the date and time have not been set, the [Date/Time] screen will be displayed in step 2. Set them following the steps in “Setting the Date and Time” (13).



Adding Other Smartphones

Only one smartphone can be assigned to the button.

- To assign a different one, clear the current assignment. Touch [FUNC.] and then [MENU], and on the [↑] tab, choose [Mobile Device Connect Button]. After the confirmation message, touch [OK], and then assign the new smartphone to the button.
- When registering multiple smartphones, add them to your list of devices to connect to in the Wi-Fi menu (87).



Adding a Smartphone Using the Wi-Fi Menu

You can also add a smartphone by touching [Wi-Fi] in Playback mode and then touching [Wi-Fi], which is displayed in the Wi-Fi menu.

The procedure for adding a smartphone through the Wi-Fi menu varies from the button approach as follows:

- The connection is established through the Wi-Fi menu (88). You cannot connect to a smartphone by pressing the button.
- The camera will remain on, even after you have disconnected from the smartphone.
- You can operate the camera to send images to the smartphone.
- Multiple smartphones can be added.
- After selecting a smartphone in step 6 of “Establishing the Smartphone Connection” (86), the privacy settings screen (where you decide whether to allow images on the camera to be displayed on the smartphone) is displayed. If you select [No], images on the camera will not be displayed on the smartphone.



- To change privacy settings for registered smartphones, choose the smartphone in [Edit a Device] (102), and then choose [View Settings].
- When a connection destination is set using the Touch Actions setting (76), you can automatically access the function to connect to the last connected destination from the next time by just dragging on the screen without needing to perform the connection operation.

Cover

Preliminary Notes and
Legal Information

Contents: Basic
Operations

Basic Guide

Advanced Guide

1 Camera Basics

2 Creative Shot
Mode

3 Auto Mode/
Hybrid Auto Mode

4 Other Shooting
Modes

5 P Mode

6 Playback Mode

7 Wi-Fi Functions

8 Setting Menu

9 Accessories

10 Appendix

Index



Accessing the Wi-Fi Menu

Initial Connection via Wi-Fi

First, register a nickname for the camera, if you have not already named it. This nickname will be displayed on the screen of target devices when connecting to other devices via Wi-Fi.



1 Access the Wi-Fi menu.

- Press the <[▶]> button to turn the camera on.
- Touch [(Ⓜ)].
- [(Ⓜ)] will be displayed during single-image display. It will not be displayed in index display.

2 Access the keyboard.

- Touch inside the frame shown at left.

3 Enter a nickname.

- Touch characters on the keyboard to enter them.
- Up to 16 characters can be used.
- Touch [<][>] to move the cursor.

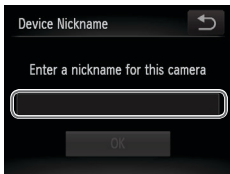

- Touch [↵] to enter capital letters.
- Touch [123] to enter numbers or symbols.
- Touch [✕] to delete the previous character.
- Touch [↩], and then touch [OK].
- ▶ The Wi-Fi menu is displayed.



- When connecting wirelessly to any device other than a computer, a memory card must be inserted in the camera. Additionally, the memory card must contain images in order for you to access Web services or connect to a smartphone or printer wirelessly.
- To change the camera's nickname, choose [Wi-Fi Settings] on the [(Ⓜ)] tab, and then choose [Change Device Nickname].

After the Initial Wi-Fi Connection

Once you have connected to other devices via Wi-Fi, recent device names will be listed first when you touch [(Ⓜ)]. Simply choose the device name to connect again.

You can register new devices by dragging left or right to access the device selection screen.



- If you prefer not to display recent target devices, touch [FUNC.] and then [MENU], and on the [(Ⓜ)] tab, choose [Wi-Fi Settings] > [Target History] > [Off].

Cover

Preliminary Notes and
Legal Information

Contents: Basic
Operations

Basic Guide

Advanced Guide

1 Camera Basics

2 Creative Shot
Mode

3 Auto Mode/
Hybrid Auto Mode

4 Other Shooting
Modes

5 P Mode

6 Playback Mode

7 Wi-Fi Functions

8 Setting Menu

9 Accessories

10 Appendix

Index



Connecting to Web Services

Set up the camera to use a variety of Web services as follows.

Adjusting Settings for Using Web Services From CANON iMAGE GATEWAY

Adjust account settings for the Web services you want to use.

- A computer is required for Web service settings, starting with CANON iMAGE GATEWAY.
- Because CameraWindow is used to adjust settings, be sure to install it from the included CD-ROM beforehand (📖21). See “System Requirements” (📖20) for server transfer system requirements.
- For information on countries and regions where CANON iMAGE GATEWAY is available, visit the Canon website (<http://canon.com/cig>).

1 Register as a CANON iMAGE GATEWAY member.

- From a computer or other device connected to the Internet, access <http://canon.com/cig> and visit the CANON iMAGE GATEWAY site for your region.
- Follow the instructions displayed to complete member registration (free of charge).
- When you will also use other Web services other than CANON iMAGE GATEWAY, you must also create an account for those services. For further details, check the websites for each Web service you want to register.

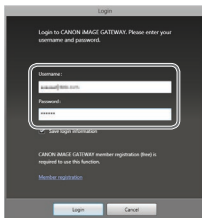
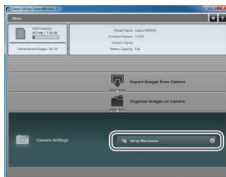

2 Connect the camera to a computer with the interface cable (📖21).

- On a computer running Windows, there is no need to connect the interface cable if you complete settings in advance (📖93). In this case, you can connect via Wi-Fi.

3 Display CameraWindow (📖22).

4 Access the CANON iMAGE GATEWAY login screen.

- Click [Camera Settings], and then click [Set Up Web Services].

5 Login to CANON iMAGE GATEWAY.

- Enter your CANON iMAGE GATEWAY login name and password, and then click [Login].

Cover

Preliminary Notes and Legal Information

Contents: Basic Operations

Basic Guide

Advanced Guide

1 Camera Basics

2 Creative Shot Mode

3 Auto Mode/Hybrid Auto Mode

4 Other Shooting Modes

5 P Mode

6 Playback Mode

7 Wi-Fi Functions

8 Setting Menu

9 Accessories

10 Appendix

Index



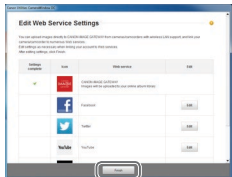



6 Set a Web service you want to use.

- Follow the on-screen instructions to complete settings for Web services you want to use.
- Once the Web service settings are complete, click [Finish] at the bottom of the window to close it.



7 Apply Web service settings to the camera.

- Choose the name of the Web service you want to set on the camera, and click  in the middle of the lists.
- ▶ The name of the Web service that will be saved to the camera will be displayed in the [Camera] list.
- Click  or  to change the order of the Web services that will be displayed in the camera's Wi-Fi menu.
- After you finish adjusting settings in the [Camera] list to your liking, close the window.
- ▶ The settings of Web services and for transferring images via the server are applied to the camera.



- An Internet connection is required to access CANON iMAGE GATEWAY (an Internet browser must be installed on the computer, you must have an account with an Internet service provider, and an Internet connection must be established).



- When connecting to CANON iMAGE GATEWAY, check the CANON iMAGE GATEWAY website for browser (Microsoft Internet Explorer, etc.) settings, conditions, and version information.
- Separate ISP connection and access point fees may be applicable.



- After logging in to CANON iMAGE GATEWAY the second time in step 5, the screen in step 7 will be displayed. To change settings for Web services you use, click [Edit Web Services].
- To add or change Web services, repeat the above procedures starting from step 2.

Establishing Web Service Connections

Connect to Web services registered to the camera.

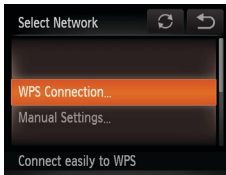

1 Access the Wi-Fi menu.

- Touch [, (p)88].

2 Choose a Web service.

- Touch the icon for the Web service you want to send images to.
- If multiple recipients are available for the same service, touch the desired recipient on the [Select Recipient] screen.

3 Connect to an access point.

- With a WPS-compatible access point, connect to the access point by following steps 4 – 6 in “Adding a Computer” (p95).
- With an access point that is not WPS-compatible, connect to the access point by following steps 2 – 3 in “Connecting to Access Points in the List” (p96).

Cover

Preliminary Notes and Legal Information

Contents: Basic Operations

Basic Guide

Advanced Guide

1 Camera Basics

2 Creative Shot Mode

3 Auto Mode/Hybrid Auto Mode

4 Other Shooting Modes

5 P Mode

6 Playback Mode

7 Wi-Fi Functions

8 Setting Menu

9 Accessories

10 Appendix

Index



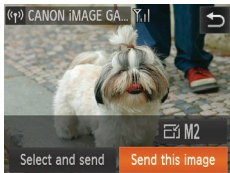

- ▶ When you have connected to the Web service, the image transfer screen will be displayed. Proceed to “Sending Images” (109).
- ▶ When [Send via Server] is selected, images will be sent as soon as a connection is established (101).

- ! When you are in the vicinity of an access point that you have previously connected to, the camera will automatically connect to it in step 2. To change access points, select [Switch Network] from the screen that will be displayed when the connection is being established, and follow steps 4 – 5 in “Adding a Computer” (95).

- ✎ When a connection destination is set using the Touch Actions setting (76), you can automatically access the function to connect to the last connected destination from the next time by just dragging on the screen without needing to perform the connection operation.

Connecting to Another Camera

Connect two cameras via Wi-Fi and send images between them as follows.



- Only Canon-brand cameras equipped with a Wi-Fi function can be connected to wirelessly. Even Canon-brand cameras that support Eye-Fi cards cannot be connected to if they do not have a Wi-Fi function. You cannot connect to DIGITAL IXUS WIRELESS cameras with this camera.

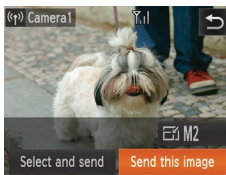
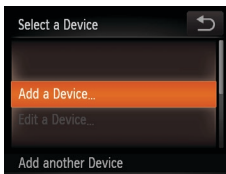
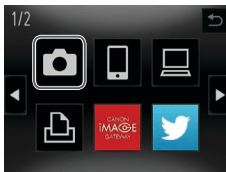

1 Access the Wi-Fi menu.

- Touch [Wi-Fi] (88).

2 Choose a camera.

- Touch [Camera].

3 Choose [Add a Device].

- Touch [Add a Device].
- Follow steps 1 – 3 on the target camera.
- ▶ Camera connection information will be added when [Start connection on target camera] is displayed on both camera screens.
- ▶ When the target camera has been added successfully, the image transfer screen will be displayed. Proceed to “Sending Images” (99).

Cover

Preliminary Notes and Legal Information

Contents: Basic Operations

Basic Guide

Advanced Guide

1 Camera Basics

2 Creative Shot Mode

3 Auto Mode/ Hybrid Auto Mode

4 Other Shooting Modes

5 P Mode

6 Playback Mode

7 Wi-Fi Functions

8 Setting Menu

9 Accessories

10 Appendix

Index





- To add multiple cameras, repeat the above procedures starting from step 1.
- Once a camera is added, the camera nickname will be displayed on the screen in step 3. To connect to a camera again, simply choose the camera nickname from the list.
- When a connection destination is set using the Touch Actions setting (📖76), you can automatically access the function to connect to the last connected destination from the next time by just dragging on the screen without needing to perform the connection operation.



Connecting to a Computer

Configure computer settings for the connection, add the computer as a connection destination, and transfer images to the computer wirelessly using the included software CameraWindow as follows.



- When connected to a computer, the camera is used to establish the connection and then the computer (included software CameraWindow) is used to transfer images.



Preparing to Register a Computer

Prepare to register a computer.



Checking Your Computer Environment

For computer environments that allow Wi-Fi connection with a camera, refer to “System Requirements” (📖20).

Additionally, the included software CameraWindow must be installed (📖21).



- Windows 7 Starter and Home Basic editions are not supported.
- Windows 7 N (European version) and KN (South Korean version) require a separate download and installation of Windows Media Feature Pack.

For further details, see the following website.

<http://go.microsoft.com/fwlink/?LinkId=159730>

Cover

Preliminary Notes and
Legal Information

Contents: Basic
Operations

Basic Guide

Advanced Guide

1 Camera Basics

2 Creative Shot
Mode

3 Auto Mode/
Hybrid Auto Mode

4 Other Shooting
Modes

5 P Mode

6 Playback Mode

7 Wi-Fi Functions

8 Setting Menu

9 Accessories

10 Appendix

Index



■ Checking Your Wi-Fi Environment

To use Wi-Fi, a Wi-Fi base unit (Wi-Fi router, etc.) that acts as your access point must be connected to a computer. Be sure to use a Wi-Fi base unit that conforms to the Wi-Fi standard listed in “Specifications” (129).

If you are already using Wi-Fi, confirm the following items and mark each one on the Check sheet. For instructions on checking network settings, refer to the access point user guide.



- If system administrator status is needed to adjust network settings, contact the system administrator for details.
- These settings are very important for network security. Exercise adequate caution when changing these settings.

Check sheet

| | |
|---|---|
| Network name (SSID/ESSID) The SSID or ESSID for the access point you use. | |
| Network certificate/data encryption (encryption method/encryption mode) The method for encrypting data during transmission via Wi-Fi. | <ul style="list-style-type: none">○ None○ WEP (open system authentication)○ WPA-PSK (TKIP)○ WPA-PSK (AES)○ WPA2-PSK (TKIP)○ WPA2-PSK (AES) |
| Encryption key (network key) The data encryption key used for transmission via Wi-Fi. | |
| Key index (sent key) The key specified when using WEP for Network certificate/data encryption. | <ul style="list-style-type: none">○ 1 |



- A router is a device that creates a network (LAN) structure for connecting multiple computers. A router that contains an internal Wi-Fi function is called a “Wi-Fi router”.
- This guide refers to all Wi-Fi routers and base stations as “access points”.
- If you use MAC address filtering on your Wi-Fi network, be sure to add the camera’s MAC address to your access point. You can check your camera’s MAC address by choosing the [↑↑] tab, [Wi-Fi Settings], and then [Check MAC Address].

■ Computer Settings for Connecting via Wi-Fi (Windows only)

On a computer running Windows, you must configure the following settings before you can connect the camera to the computer wirelessly.



1 Confirm the computer is connected to Wi-Fi.

- For instructions on checking your network connection, refer to the computer user manual.

2 Configure the setting.

- Click in the following order: [Start] menu ► [All Programs] ► [Canon Utilities] ► [CameraWindow] ► [Wi-Fi connection setup].
- In the application that opens, follow the on-screen instructions and configure the setting.

Cover

Preliminary Notes and Legal Information

Contents: Basic Operations

Basic Guide

Advanced Guide

1 Camera Basics

2 Creative Shot Mode

3 Auto Mode/Hybrid Auto Mode

4 Other Shooting Modes

5 P Mode

6 Playback Mode

7 Wi-Fi Functions

8 Setting Menu

9 Accessories

10 Appendix

Index





- The following Windows settings are configured when you run the utility in step 2.
 - Turn on media streaming.
 - This will enable the camera to find the computer to access via Wi-Fi.
 - Turn on network discovery.
 - This will enable the computer to find the camera.
 - Turn on ICMP (Internet Control Message Protocol).
 - This allows you to check the network connection status.
 - Enable Universal Plug & Play (UPnP).
 - This will enable network devices to detect each other automatically.
- Some security software may prevent you from completing the settings as described here. Check the settings of your security software.



Adding a Computer

Add a computer to your list of devices to connect to via Wi-Fi. Follow these instructions when using a Wi-Fi Protected Setup (WPS) compatible access point to establish a push-button connection. If your access point is not WPS-compatible, establish a connection as described in “Connecting to Access Points in the List” (📖96).



- WPS makes it easy to complete settings when connecting devices over Wi-Fi. You can use either Push Button Configuration Method or PIN Method for settings on a WPS supported device.
 - Refer to the user guide provided with your access point to check if it supports WPS.
 - Be sure to also read the user guide included with your access point.

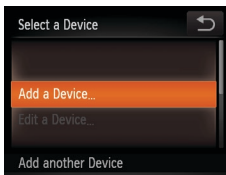

1 Access the Wi-Fi menu.

- Touch [Wi-Fi] (📖88).

2 Choose a computer.

- Touch [📖].

3 Choose [Add a Device].

- Touch [Add a Device].
 - ▶ A list of detected access points will be displayed in the [Select Network] screen.

Cover

Preliminary Notes and Legal Information

Contents: Basic Operations

Basic Guide

Advanced Guide

1 Camera Basics

2 Creative Shot Mode

3 Auto Mode/ Hybrid Auto Mode

4 Other Shooting Modes

5 P Mode

6 Playback Mode

7 Wi-Fi Functions

8 Setting Menu

9 Accessories

10 Appendix

Index



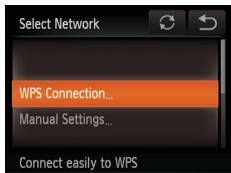

4 Choose [WPS Connection].

- Touch [WPS Connection].

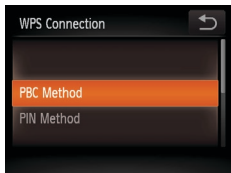

5 Choose [PBC Method].

- Touch [PBC Method].

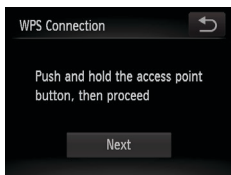

6 Establish the connection.

- On the access point, hold down the WPS connection button for a few seconds.
- Touch [Next].
- ▶ The camera will connect to the access point.
- ▶ A list of computers connected to the access point will appear in the [Select a Device] screen.

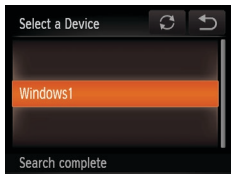

7 Choose a computer to connect to.

- Touch the name of the computer you want to connect to.
- When using a Macintosh computer, see “Using CameraWindow to Transfer Images to a Computer” (📖97).

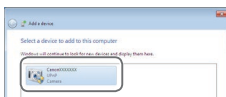

8 Install a driver (first Windows connection only).

- When the screen at left is displayed on the camera, click the Start menu on the computer, click [Control Panel], and then click [Add a device].

- Double click the connected camera icon.
- ▶ Driver installation will begin.
- ▶ After driver installation is complete, and the camera and computer connection is enabled, the AutoPlay screen will be displayed. Nothing will be displayed on the camera screen.
- Proceed to “Using CameraWindow to Transfer Images to a Computer” (📖97).

- ⚠ When you are in the vicinity of an access point that you have previously connected to, the camera will automatically connect to it in step 3. To change access points, select [Switch Network] from the screen that will be displayed when the connection is being established, and follow steps 4 – 5 in “Adding a Computer” (📖95).

| |
|---|
| Cover |
| Preliminary Notes and Legal Information |
| Contents: Basic Operations |
| Basic Guide |
| Advanced Guide |
| 1 Camera Basics |
| 2 Creative Shot Mode |
| 3 Auto Mode/Hybrid Auto Mode |
| 4 Other Shooting Modes |
| 5 P Mode |
| 6 Playback Mode |
| 7 Wi-Fi Functions |
| 8 Setting Menu |
| 9 Accessories |
| 10 Appendix |
| Index |





- If you chose [PIN Method] in step 5, a PIN code will be displayed on the screen. Be sure to set this code in the access point. Choose a device in the [Select a Device] screen. For further details, refer to the user guide included with your access point.
- To add multiple computers, repeat the above procedures starting from step 1.
- When finished adding computers, touch [↶] in the upper right of the image transfer screen displayed after you connect to a computer in step 7. Touch [OK] after the confirmation message.
- To disconnect from the camera, turn off the camera.
- When a connection destination is set using the Touch Actions setting (📖76), you can automatically access the function to connect to the last connected destination from the next time by just dragging on the screen without needing to perform the connection operation.

Connecting to Access Points in the List

1 View the listed access points.

- View the listed access points as described in steps 1 – 3 of “Adding a Computer” (📖94).

2 Choose an access point.

- Touch the network (access point) that you want to connect to.

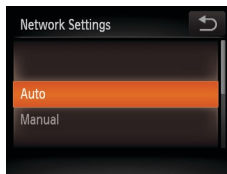
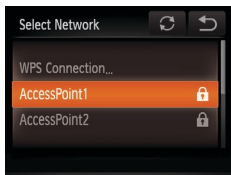

3 Enter the access point's encryption key.

- Touch inside the frame shown at left to access the keyboard, and then enter the encryption key (📖88).
- Touch [Next].

4 Choose [Auto].

- Touch [Auto].
- ▶ A list of other devices connected to the access point will appear in the [Select a Device] screen.

5 Choose a computer to connect to.

- Choose the computer to connect to, following steps 7 – 8 in “Adding a Computer” (📖95). The computer is now added to the list.



- For information on the access point's encryption key, refer to the body of the access point or its user manual.
- Up to 16 access points will be displayed. If no access points are detected, choose [Manual Settings] in step 2 to manually set an access point. Follow on-screen instructions and enter an SSID, security settings, and an encryption key.
- When you use an access point that you have already connected to for connecting to another device, [*] is displayed for the encryption key in step 3. To use the same encryption key, touch [Next].
- To add multiple computers, repeat the above procedures starting from step 1.

Cover

Preliminary Notes and Legal Information

Contents: Basic Operations

Basic Guide

Advanced Guide

1 Camera Basics

2 Creative Shot Mode

3 Auto Mode/Hybrid Auto Mode

4 Other Shooting Modes

5 P Mode

6 Playback Mode

7 Wi-Fi Functions

8 Setting Menu

9 Accessories

10 Appendix

Index



Using CameraWindow to Transfer Images to a Computer

Use the computer (included software CameraWindow) to transfer images from the camera to the computer.



- For details on how to use CameraWindow, see the *Software Guide* (📖20).

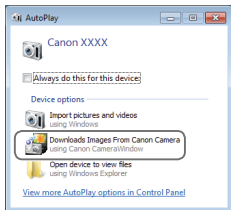

1 Display CameraWindow.

- In Windows, click [Downloads Images From Canon Camera using Canon CameraWindow].
 - ▶ CameraWindow will be displayed.
 - ▶ On a Macintosh computer, CameraWindow is automatically displayed when a Wi-Fi connection is established between the camera and computer.

2 Import images.

- Click [Import Images from Camera], and then click [Import Untransferred Images].
 - ▶ Images are now saved to the Pictures folder on the computer, in separate folders named by date.
- Click [OK] in the screen that is displayed after image import is complete.

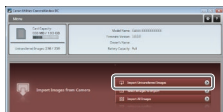
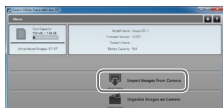

- If CameraWindow is not displayed when using a Macintosh computer, click the [CameraWindow] icon in the Dock.
- Movies will take longer to import since the file size is larger than still images.
- To disconnect from the camera, turn off the camera.
- You can also specify to save all images or only selected images to the computer, and you can change the destination folder. Refer to the *Software Guide* (📖20) for details.

Cover

Preliminary Notes and Legal Information

Contents: Basic Operations

Basic Guide

Advanced Guide

1 Camera Basics

2 Creative Shot Mode

3 Auto Mode/Hybrid Auto Mode

4 Other Shooting Modes

5 P Mode

6 Playback Mode

7 Wi-Fi Functions

8 Setting Menu

9 Accessories

10 Appendix

Index



Connecting to a Printer

Connect the camera to a printer via Wi-Fi to print as follows. When establishing a Wi-Fi connection with a printer, you can either use the camera as an access point (Camera Access Point mode) or use another access point.

Follow these instructions when using the camera as an access point. When using another access point, see “Connecting to Access Points in the List” (96) in “Adding a Computer”.

1 Access the Wi-Fi menu.

- Touch [(Wi-Fi)] (88).

2 Choose a printer.

- Touch [Printer1].

3 Choose [Add a Device].

- Touch [Add a Device].

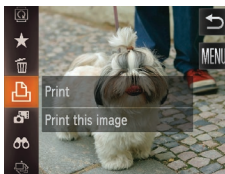
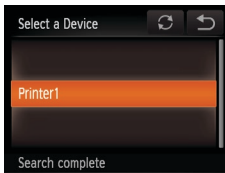
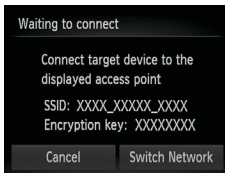
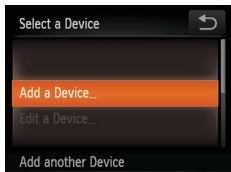
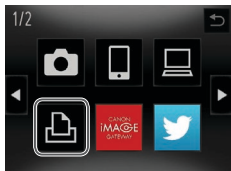

4 Use the printer to connect to the network displayed on the camera screen.

- Choose the displayed SSID (network name) from the printer's Wi-Fi setting menu.

5 Choose the printer.

- Once the printer is ready for the connection, touch the printer name when it is displayed on the camera.
- ▶ When the printer has been added successfully, the printing screen will be displayed.

6 Choose an image to print.

- Drag left or right across the screen to choose an image. Touch [FUNC.] and then [Print].
- ▶ Printing now begins.
- For detailed printing instructions, see “Printing Images” (115).

- ✎ You can connect to access points that you have already connected to by choosing them on the [Select a Device] screen in step 3.
- When a connection destination is set using the Touch Actions setting (76), you can automatically access the function to connect to the last connected destination from the next time by just dragging on the screen without needing to perform the connection operation.

Cover

Preliminary Notes and Legal Information

Contents: Basic Operations

Basic Guide

Advanced Guide

1 Camera Basics

2 Creative Shot Mode

3 Auto Mode/Hybrid Auto Mode

4 Other Shooting Modes

5 P Mode

6 Playback Mode

7 Wi-Fi Functions

8 Setting Menu

9 Accessories

10 Appendix

Index



Sending Images

Send images wirelessly to destinations registered on the camera as follows.



- Images can be uploaded to social networking services or sent to email addresses, via CANON iMAGE GATEWAY. See CANON iMAGE GATEWAY for details.
- Up to 50 images can be sent together at once. You can send movies together as long as the total playback time is within two minutes. However, if the destination is a Web service, the number of movies and images that can be sent may be less depending on the Web service. See the desired Web service for details.
- Depending on the condition of the network you are using, it may take a long time to send movies. Be sure to keep an eye on the camera battery level.
- When connected to a computer, images are transferred using the computer (included software CameraWindow) instead of the camera (97).

Sending Images Individually

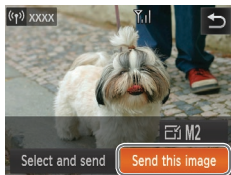

1 Choose an image.

- Drag left or right across the screen to choose an image to send.

2 Send the image.

- Touch [Send this image].
- When uploading to YouTube, read the terms of service, and touch [I Agree].
- ▶ Image transfer will begin.

- ▶ After images are uploaded to a Web service, touch [OK] on the screen that is displayed to return to the playback screen.
- ▶ After sending images to a camera or smartphone, [Transfer completed] will be displayed, and the display will return to the image transfer screen.



- Keep your fingers or other objects off the Wi-Fi transmitter-receiver (3). Covering this may decrease the speed of your image transfers.
- On the screen, wireless signal strength is indicated by the following icons: [Full bars] high, [3 bars] medium, [2 bars] low, [1 bar] weak. However, no icon is displayed when the camera is used as an access point.
- To disconnect from the camera, touch [Disconnect] in the upper right of the screen, and then touch [OK] in the disconnection confirmation screen. You can also use the smartphone to end the connection.

Choosing the Image Resolution (Size)

You can choose the resolution (size) of images to send by touching [M] on the image transmission screen.

- To send images at original size, select [No] as the resizing option.
- Choosing [M2] or [S] will resize images that are larger than the selected size before sending.



- Movies cannot be resized.

Cover

Preliminary Notes and Legal Information

Contents: Basic Operations

Basic Guide

Advanced Guide

1 Camera Basics

2 Creative Shot Mode

3 Auto Mode/ Hybrid Auto Mode

4 Other Shooting Modes

5 P Mode

6 Playback Mode

7 Wi-Fi Functions

8 Setting Menu

9 Accessories

10 Appendix

Index



Sending Multiple Images

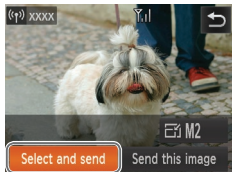

1 Choose [Select and send].

- Touch [Select and send].



2 Choose images.

- Touching an image to send will label it with a [✓] icon.
- To cancel selection, touch the image again. [✓] is no longer displayed.
- Repeat this process to choose additional images.
- After you finish choosing images, touch [OK].

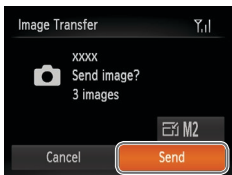

3 Send the images.

- Touch [Send].



- You can also choose images by switching to single-image display (📖68) in step 2 and dragging left or right across the screen.
- In step 3, you can choose the resolution (size) to resize images to before sending (📖99).

Adding Comments

Using the camera, you can add comments (alphanumeric characters and symbols) to images that you send to email addresses, social networking services, etc. The number of characters and symbols that can be entered may differ depending on the Web service.

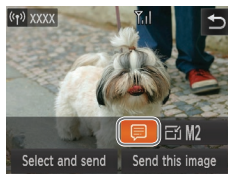

1 Choose [🗨️].

- Touch [🗨️].

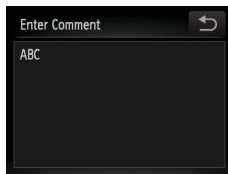

2 Add a comment.

- Follow step 3 in “Initial Connection via Wi-Fi” (📖88) to add a comment.

3 Send the image.

- Follow the steps in “Sending Images Individually” (📖99) to send the image.



- When a comment is not entered, the comment set in CANON iMAGE GATEWAY is automatically sent.

Cover

Preliminary Notes and Legal Information

Contents: Basic Operations

Basic Guide

Advanced Guide

1 Camera Basics

2 Creative Shot Mode

3 Auto Mode/ Hybrid Auto Mode

4 Other Shooting Modes

5 P Mode

6 Playback Mode

7 Wi-Fi Functions

8 Setting Menu

9 Accessories

10 Appendix

Index



Sending Images to a Computer via CANON IMAGE GATEWAY

Images on the memory card that have not been transferred already can be sent to a computer via CANON iMAGE GATEWAY.

If the computer that you intend to send images to is turned off, the images will be stored temporarily on the CANON iMAGE GATEWAY server. However, the images will be deleted after a while. Start up the computer so that they can be saved.

1 Choose the type of images to send (only when sending movies with images).

- Touch [FUNC.], touch [MENU], and choose [Wi-Fi Settings] on the [↑↑] tab (p.30).
- Choose [Send via Server], and then choose [Stills/Movies].
- When sending only still images, go to step 2.

2 Send the images.

- Follow the steps in “Establishing Web Service Connections” (p.90) to choose [↑].
- ▶ Once the connection is established, the images are sent. (The screen will close in about one minute.)
- After the images are sent, touch [OK] to return to the playback screen.
- ▶ When the images have been sent successfully to the CANON iMAGE GATEWAY server, [↑↑] is displayed on the screen.

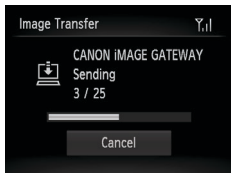
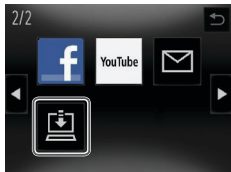

3 Turn on the computer.

- Images are automatically saved to the computer when you turn it on.



- When sending images, you should use a fully charged battery or an AC adapter kit (sold separately, p.112).



- Even if images were imported to the computer through a different method, any images not sent to the computer via CANON iMAGE GATEWAY will be sent to the computer.

Cover

Preliminary Notes and
Legal Information

Contents: Basic
Operations

Basic Guide

Advanced Guide

1 Camera Basics

2 Creative Shot
Mode

3 Auto Mode/
Hybrid Auto Mode

4 Other Shooting
Modes

5 P Mode

6 Playback Mode

7 Wi-Fi Functions

8 Setting Menu

9 Accessories

10 Appendix

Index



Geotagging Images on the Camera

GPS data recorded on a smartphone using the dedicated CameraWindow application (📖85) can be added to images on the camera. Images are tagged with information including the latitude, longitude, and elevation.



- Before shooting, make sure the date and time and your home time zone are set correctly. (See “Setting the Date and Time” (📖13).) Additionally, in [Time Zone] (📖106), specify any shooting destinations that are in other time zones.
- The smartphone you will use for geotagging must be authorized to view the images on the camera (📖87).
- Others may be able to locate or identify you by using location data in your geotagged still images or movies. Be careful when sharing these images with others, as when posting images online where many others can view them.

Editing or Erasing Wi-Fi Settings

Edit or erase Wi-Fi settings as follows.

Editing Connection Information

Edit connection information saved to the camera. You can change device nicknames (display names) that are displayed on the camera, and erase connection information.

The following explains the procedure when the target device is a computer.

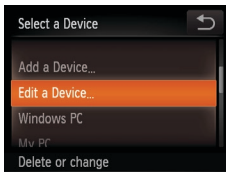
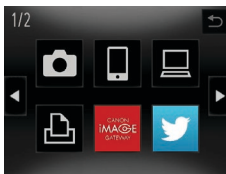

1 Access the Wi-Fi menu.

- Touching [☰] will show recent target devices. To access the Wi-Fi menu, touch [◀|▶].

2 Choose a device to edit.

- Touch the icon for the device you want to edit.

3 Choose [Edit a Device].

- Touch [Edit a Device].

Cover

Preliminary Notes and Legal Information

Contents: Basic Operations

Basic Guide

Advanced Guide

1 Camera Basics

2 Creative Shot Mode

3 Auto Mode/ Hybrid Auto Mode

4 Other Shooting Modes

5 P Mode

6 Playback Mode

7 Wi-Fi Functions

8 Setting Menu

9 Accessories

10 Appendix

Index



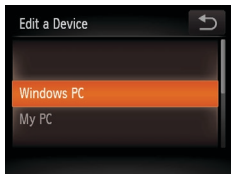

4 Choose a device to edit.

- Touch the device you want to edit.

5 Choose an option to edit.

- Touch the option you want to edit.
- The settings you can change depend on what device or service the camera will access.

| Configurable Settings | Connection | | | | |
|---------------------------------|------------|---|---|---|--------------|
| | | | | | Web Services |
| [Change Device Nickname] (📖103) | ○ | ○ | ○ | ○ | – |
| [View Settings] (📖87) | – | ○ | – | – | – |
| [Erase Connection Info] (📖103) | ○ | ○ | ○ | ○ | – |

○ : Configurable – : Not configurable

Changing a Device Nickname

You can change the device nickname (display name) that is displayed on the camera.

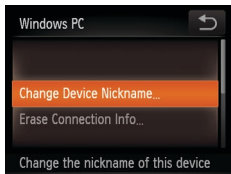

- Following step 5 in “Editing Connection Information” (📖103), touch [Change Device Nickname] to choose it.
- Touch the input field and a keyboard will be displayed. Enter the new nickname (📖88).

Erasing Connection Information

Erase connection information (information about devices that you have connected to) as follows.

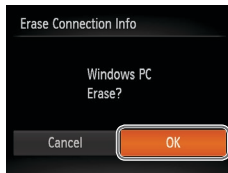

- Following step 5 in “Editing Connection Information” (📖103), touch [Erase Connection Info] to choose it.
- When [Erase (connection information)?] is displayed, touch [OK].
- ▶ The connection information is now erased, and the display reverts to the screen in step 1.

Returning the Wi-Fi Settings to Default

Return the Wi-Fi settings to default if you transfer ownership of the camera to another person, or dispose of it.



1 Choose [Wi-Fi Settings].

- Touch [FUNC.], touch [MENU], and choose [Wi-Fi Settings] on the [FUNC.] tab (📖30).

Cover

Preliminary Notes and Legal Information

Contents: Basic Operations

Basic Guide

Advanced Guide

1 Camera Basics

2 Creative Shot Mode

3 Auto Mode/ Hybrid Auto Mode

4 Other Shooting Modes

5 P Mode

6 Playback Mode

7 Wi-Fi Functions

8 Setting Menu

9 Accessories

10 Appendix

Index



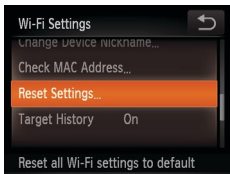

2 Choose [Reset Settings].

- Touch [Reset Settings].

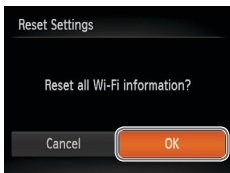

3 Restore the default settings.

- Touch [OK].
- ▶ The Wi-Fi settings are now reset.



- Settings assigned to the $\langle \square \rangle$ button (📖85) are also reset.
- When returning the Wi-Fi settings to defaults, all Web services set using a computer will also be erased from the camera. Be sure that you want to reset all Wi-Fi settings before using this option. To clear the settings completed in “Sending Images to a Computer via CANON iMAGE GATEWAY” (📖101), connect your camera to the computer and use CameraWindow to erase the connection information.
- To reset other settings (aside from Wi-Fi) to defaults, choose [Reset All] in the [📏] tab.

Cover

Preliminary Notes and Legal Information

Contents: Basic Operations

Basic Guide

Advanced Guide

1 Camera Basics

2 Creative Shot Mode

3 Auto Mode/Hybrid Auto Mode

4 Other Shooting Modes

5 P Mode

6 Playback Mode

7 Wi-Fi Functions

8 Setting Menu

9 Accessories

10 Appendix

Index



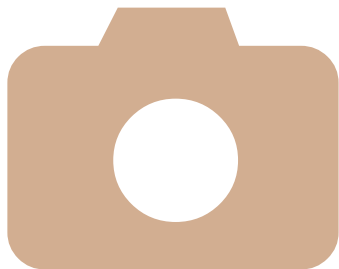

8

Setting Menu

Customize or adjust basic camera functions for greater convenience

Adjusting Basic Camera
Functions.....106

- Cover
- Preliminary Notes and Legal Information
- Contents: Basic Operations
- Basic Guide
- Advanced Guide
- 1 Camera Basics
- 2 Creative Shot Mode
- 3 Auto Mode/Hybrid Auto Mode
- 4 Other Shooting Modes
- 5 P Mode
- 6 Playback Mode
- 7 Wi-Fi Functions
- 8 Setting Menu**
- 9 Accessories
- 10 Appendix
- Index



Adjusting Basic Camera Functions

Functions can be configured on the [Y/T] tab. Customize commonly used functions as desired, for greater convenience (📖30).

Silencing Camera Operations

Silence camera sounds and movies as follows.

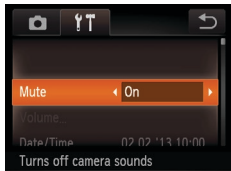

- Choose [Mute], and then choose [On].



- Sound is not played during movies if you mute camera sounds (📖65). To restore sound during movies, drag up across the screen. Adjust volume by dragging up or down, as needed.

Adjusting the Volume

Adjust the volume of individual camera sounds as follows.

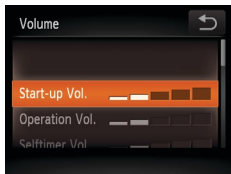

- Touch [Volume].
- Drag up or down to choose an item, and then adjust the volume by touching the desired position on the bar.

Date and Time

Adjust the date and time as follows.

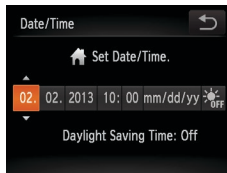

- Touch [Date/Time].
- Touch the item to configure, and then touch [▲][▼] to adjust the setting.

World Clock

To ensure that your shots will have the correct local date and time when you travel abroad, simply register the destination in advance and switch to that time zone. This convenient feature eliminates the need to change the Date/Time setting manually.

Before using the world clock, be sure to set the date and time and your home time zone, as described in “Setting the Date and Time” (📖13).

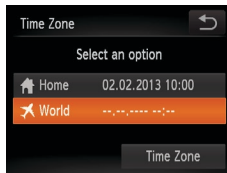

1 Specify your destination.

- Touch [Time Zone].
- Touch [✈ World], and then touch [Time Zone].
- Touch [◀|▶] to choose the destination time zone.
- To set daylight saving time (1 hour ahead), touch [☀] and choose [☀].
- Touch [↶].

Cover

Preliminary Notes and Legal Information

Contents: Basic Operations

Basic Guide

Advanced Guide

1 Camera Basics

2 Creative Shot Mode

3 Auto Mode/Hybrid Auto Mode

4 Other Shooting Modes

5 P Mode

6 Playback Mode

7 Wi-Fi Functions

8 Setting Menu

9 Accessories

10 Appendix

Index



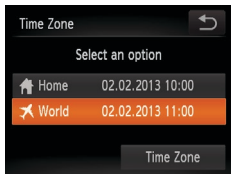

2 Switch to the destination time zone.

- Touch [World], and then touch [].
- ▶ [] is now shown on the shooting screen (124).



- Adjusting the date or time while in [] mode (13) will automatically update your [Home] time and date.

Lens Retraction Timing

The lens is normally retracted for safety about one minute after you press the button in Shooting mode (26). To have the lens retracted immediately after you press the button, set the retraction timing to [0 sec.].



- Choose [Lens Retract], and then choose [0 sec.].

Using Eco Mode

This function allows you to conserve battery power in Shooting mode. When the camera is not in use, the screen quickly darkens to reduce battery consumption.



1 Configure the setting.

- Choose [Eco Mode], and then choose [On].
- ▶ [] is now shown on the shooting screen (124).
- ▶ The screen darkens when the camera is not used for approximately two seconds; approximately ten seconds after darkening, the screen turns off. The camera turns off after approximately three minutes of inactivity.

2 Shoot.

- To activate the screen and prepare for shooting when the screen is off but the lens is still out, press the shutter ring halfway.

Cover

Preliminary Notes and Legal Information

Contents: Basic Operations

Basic Guide

Advanced Guide

1 Camera Basics

2 Creative Shot Mode

3 Auto Mode/ Hybrid Auto Mode

4 Other Shooting Modes

5 P Mode

6 Playback Mode

7 Wi-Fi Functions

8 Setting Menu

9 Accessories

10 Appendix

Index



Screen Brightness

Adjust screen brightness as follows.

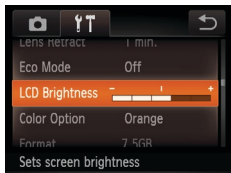

- Choose [LCD Brightness], and then touch the desired position on the bar to adjust the brightness.

Screen Color Scheme

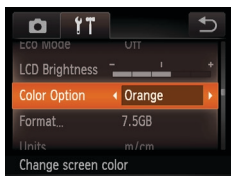

- Choose [Color Option], and then choose an option.

Formatting Memory Cards

Before using a new memory card or a card formatted in another device, you should format the card with this camera.

Formatting erases all data on a memory card. Before formatting, copy images on the memory card to a computer, or take other steps to back them up.

1 Access the [Format] screen.

- Touch [Format].

2 Choose [OK].

- Touch [OK].

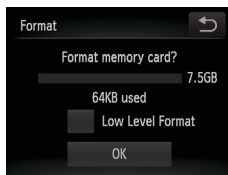

3 Format the memory card.

- To begin the formatting process, touch [OK].
- When formatting is finished, [Memory card formatting complete] is displayed. Touch [OK].

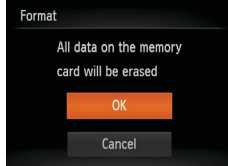

- ⚠ • Formatting or erasing data on a memory card only changes file management information on the card and does not erase the data completely. When transferring or disposing of memory cards, take steps to protect personal information if necessary, as by physically destroying cards.

- ✎ • The total card capacity indicated on the formatting screen may be less than the advertised capacity.

Cover

Preliminary Notes and Legal Information

Contents: Basic Operations

Basic Guide

Advanced Guide

1 Camera Basics

2 Creative Shot Mode

3 Auto Mode/Hybrid Auto Mode

4 Other Shooting Modes

5 P Mode

6 Playback Mode

7 Wi-Fi Functions

8 Setting Menu

9 Accessories

10 Appendix

Index



Low-Level Formatting

Perform low-level formatting in these cases: [Memory card error] is displayed, the camera is not working correctly, card image reading/writing is slower, continuous shooting is slower, or movie recording suddenly stops. Low-level formatting erases all data on a memory card. Before low-level formatting, copy images on the memory card to a computer, or take other steps to back them up.

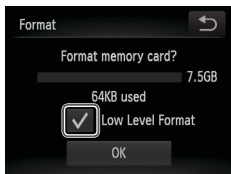

- Touch the field to the left of [Low Level Format] to select it (mark with a [✓]).
- Follow steps 2 – 3 in “Formatting Memory Cards” (📖108) to continue with the formatting process.



- Low-level formatting takes longer than “Formatting Memory Cards” (📖108), because data is erased from all storage regions of the memory card.
- You can cancel low-level formatting in progress by touching [Stop]. In this case, all data will be erased, but the memory card can be used normally.

Metric/Non-Metric Display

Change the unit of measurement shown in GPS information for elevation (📖67) and elsewhere from m/cm to ft/in as needed.



- Choose [Units], and then choose [ft/in].

Increasing Touch-Screen Panel Sensitivity

Sensitivity of the touch-screen panel can be increased, so that the camera responds to a lighter touch.



- Choose [Touch Response], and then choose [High].

Adjusting Wi-Fi Settings

The following options are available by choosing [Wi-Fi Settings] > [Mobile Device Connect Button].

- Change the nickname (📖103)
- Check the camera's MAC address (📖93)
- Reset the Wi-Fi settings (📖103)
- Disable display of recent target devices (📖88)
- Remove smartphones assigned to the button (📖104)

Cover

Preliminary Notes and Legal Information

Contents: Basic Operations

Basic Guide

Advanced Guide

1 Camera Basics

2 Creative Shot Mode

3 Auto Mode/Hybrid Auto Mode

4 Other Shooting Modes

5 P Mode

6 Playback Mode

7 Wi-Fi Functions

8 Setting Menu

9 Accessories

10 Appendix

Index



Checking Certification Logos

Some logos for certification requirements met by the camera can be viewed on the screen. Other certification logos are printed in this guide, on the camera packaging, or on the camera body.

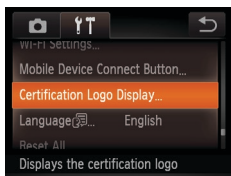

- Touch [Certification Logo Display].

Display Language

Change the display language as needed.

| | | |
|-------------|-----------|---------|
| English | Suomi | Magyar |
| Deutsch | Norsk | Türkçe |
| Français | Svenska | 繁體中文 |
| Nederlands | Español | 한국어 |
| Dansk | 简体中文 | മലയാളം |
| Italiano | Русский | العربية |
| Українська | Português | Română |
| B. Malaysia | Ελληνικά | فارسی |
| Indonesian | Polski | हिन्दी |
| Tiếng Việt | Čeština | 日本語 |

- Touch [Language].
- Touch a display language to choose it, and then touch the language again.



- You can also access the [Language] screen in Playback mode by touching [FUNC.] and then touching and holding [MENU].

Restoring Defaults

If you accidentally change a setting, you can restore default camera settings.

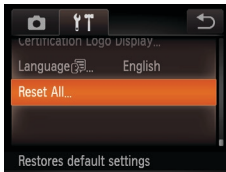

- Touch [Reset All].
- Touch [OK].
- ▶ Default settings are now restored.



- The following functions are not restored to default settings.
 - Information registered using Face ID (106)
 - [Wi-Fi] tab settings [Date/Time] (106), [Time Zone] (106), and [Language] (110)
 - Shooting mode (53)
 - Wi-Fi settings (80)

Cover

Preliminary Notes and Legal Information

Contents: Basic Operations

Basic Guide

Advanced Guide

1 Camera Basics

2 Creative Shot Mode

3 Auto Mode/Hybrid Auto Mode

4 Other Shooting Modes

5 P Mode

6 Playback Mode

7 Wi-Fi Functions

8 Setting Menu

9 Accessories

10 Appendix

Index



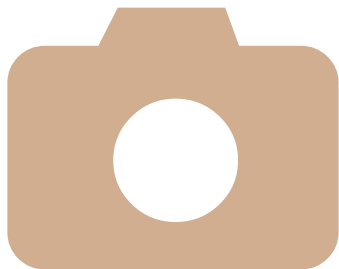

9

Accessories

Enjoy the camera in more ways with optional Canon accessories and other compatible accessories sold separately

| | |
|------------------------------------|-----|
| Optional Accessories..... | 112 |
| Using Optional Accessories..... | 113 |
| Printing Images | 115 |

| |
|--|
| Cover |
| Preliminary Notes and Legal Information |
| Contents: Basic Operations |
| Basic Guide |
| Advanced Guide |
| 1 Camera Basics |
| 2 Creative Shot Mode |
| 3 Auto Mode/ Hybrid Auto Mode |
| 4 Other Shooting Modes |
| 5 P Mode |
| 6 Playback Mode |
| 7 Wi-Fi Functions |
| 8 Setting Menu |
| 9 Accessories |
| 10 Appendix |
| Index |



Optional Accessories

The following camera accessories are sold separately. Note that availability varies by area, and some accessories may no longer be available.

Power Supplies

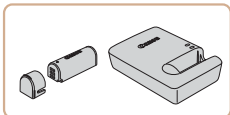

Battery Pack NB-9L

- Rechargeable lithium-ion battery

Battery Charger CB-2LB/CB-2LBE

- Charger for Battery Pack NB-9L

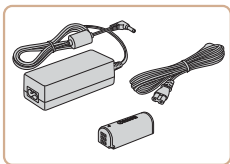

AC Adapter Kit ACK-DC70

- For powering the camera using household power. Recommended when using the camera over extended periods, or when connecting the camera to a printer or computer. Cannot be used to charge the camera battery.



- The battery charger and AC adapter kit can be used in areas with 100 – 240 V AC power (50/60 Hz).
- For power outlets in a different format, use a commercially available adapter for the plug. Never use an electrical transformer designed for traveling, which may damage the battery.

Printers

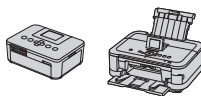

Canon-brand PictBridge-Compatible Printers

- Printing images without a computer is possible by connecting the camera to a Canon-brand PictBridge-compatible printer. For details, visit your nearest Canon dealer.

Cover

Preliminary Notes and Legal Information

Contents: Basic Operations

Basic Guide

Advanced Guide

1 Camera Basics

2 Creative Shot Mode

3 Auto Mode/Hybrid Auto Mode

4 Other Shooting Modes

5 P Mode

6 Playback Mode

7 Wi-Fi Functions

8 Setting Menu

9 Accessories

10 Appendix

Index



Using Optional Accessories

Using the Battery Charger to Charge the Battery

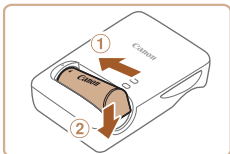

1 Insert the battery.

- After aligning the ▲ marks on the battery and charger, insert the battery by pushing it in (①) and down (②).

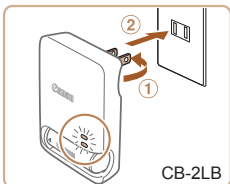

CB-2LB

2 Charge the battery.

- **CB-2LB:** Flip out the plug (①) and plug the charger into a power outlet (②).
- **CB-2LBE:** Plug the power cord into the charger, then plug the other end into a power outlet.
- ▶ The charging lamp turns orange and charging begins.
- ▶ When charging is finished, the lamp turns green.

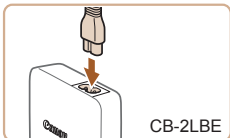

CB-2LBE

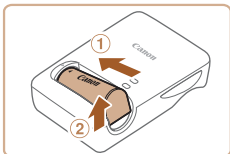

3 Remove the battery.

- After unplugging the battery charger, remove the battery by pushing it in (①) and up (②).



- To protect the battery and keep it in optimal condition, do not charge it continuously for more than 24 hours.
- For battery chargers that use a power cord, do not attach the charger or cord to other objects. Doing so could result in malfunction or damage to the product.



- For details on charging time and the number of shots and recording time possible with a fully charged battery, see "Number of Shots/Recording Time, Playback Time" (📖 130).
- Charged batteries gradually lose their charge, even when they are not used. Charge the battery on (or immediately before) the day of use.
- The charger can be used in areas with 100 – 240 V AC power (50/60 Hz). For power outlets in a different format, use a commercially available adapter for the plug. Never use an electrical transformer designed for traveling, which may damage the battery.

Powering the Camera with Household Power

Powering the camera with AC Adapter Kit ACK-DC70 (sold separately) eliminates the need to monitor the remaining battery level.

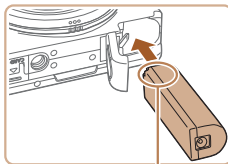

Terminals

1 Make sure the camera is off.

2 Insert the coupler.

- Follow step 1 in "Inserting and Charging the Battery" (📖 11) to open the cover.
- Insert the coupler facing the direction shown, just as you would a battery (following step 2 in "Inserting and Charging the Battery" (📖 11)).
- Follow step 3 in "Inserting and Charging the Battery" (📖 11) to close the cover.



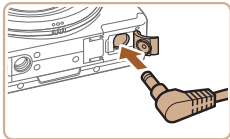

3 Connect the adapter to the coupler.

- Open the cover and insert the adapter plug fully into the coupler.

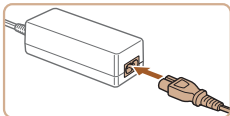

4 Connect the power cord.

- Insert one end of the power cord into the compact power adapter, and then plug the other end into a power outlet.
- Turn the camera on and use it as desired.
- When finished, turn the camera off and unplug the power cord from the outlet.



- Do not disconnect the adapter or unplug the power cord while the camera is still on. This may erase your shots or damage the camera.
- Do not attach the adapter or adapter cord to other objects. Doing so could result in malfunction or damage to the product.

Cover

Preliminary Notes and
Legal Information

Contents: Basic
Operations

Basic Guide

Advanced Guide

1 Camera Basics

2 Creative Shot
Mode

3 Auto Mode/
Hybrid Auto Mode

4 Other Shooting
Modes

5 P Mode

6 Playback Mode

7 Wi-Fi Functions

8 Setting Menu

9 Accessories

10 Appendix

Index



Printing Images

Your shots can easily be printed by connecting the camera to a printer. A Canon SELPHY CP series compact photo printer is used here for the sake of illustration. Screens displayed and available functions vary by printer. Also refer to the printer manual for additional information.

Printing Still Images

Easily print your shots by connecting the camera to a PictBridge-compatible printer (sold separately) with the included interface cable (📖 2).

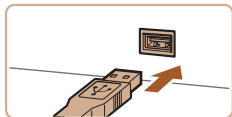
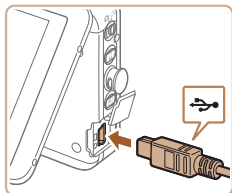

1 Make sure the camera and printer are off.

2 Connect the camera to the printer.

- Open the cover. Holding the smaller cable plug in the orientation shown, insert the plug fully into the camera terminal.
- Connect the larger cable plug to the printer. For other connection details, refer to the printer manual.

3 Turn the printer on.

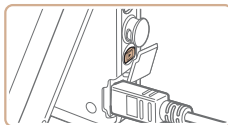

4 Turn the camera on.

- Press the <▶> button to turn the camera on.

5 Choose an image.

- Browse images by dragging left or right, and then touch an image to choose it.

6 Print the image.

- Touch [FUNC.], and then touch [🖨️].
- ▶ Printing now begins.
- To print other images, repeat the above procedures starting from step 5 after printing is finished.
- When you are finished printing, turn the camera and printer off and disconnect the cable.

- ⚠️ Use the printer to configure the paper size, layout, and so on. These settings cannot be configured from the camera.
- If the printer or settings are unconfigurable, default printer settings will be used. For details on default printer settings, refer to the printer manual.

- ✎ For Canon-brand PictBridge-compatible printers (sold separately), see "Printers" (📖 112).



Printing Movie Scenes

Print the current still image in a paused movie as follows.

1 Access the printing screen.

- Follow steps 1 – 5 in “Printing Still Images” (115) to choose a movie.

2 Choose the scene to print.

- Touch the screen to start movie playback, and touch it again when the desired scene is displayed.
- ▶ Playback is paused, and the movie control panel is displayed.

3 Print the image.

- Touch [Print].
- ▶ Printing now begins.



Adding Images to a Photobook

Photobooks can be set up on the camera by choosing up to 998 images on a memory card and importing them into the included software on your computer, where they are stored in their own folder. This is convenient when ordering printed photobooks online or printing photobooks with your own printer.

Choosing a Selection Method



- Touch [FUNC.], touch [MENU], and then touch [Photobook Set-up] on the [Play] tab, and then choose how you will select images.

- ⓘ [Info] may be displayed on the camera to warn you that the memory card has print settings that were configured on another camera. Changing the print settings using this camera may overwrite all previous settings.

- ✎ After importing images to your computer, also refer to the *Software Guide* (20) and the printer manual for further information.

Adding Images Individually

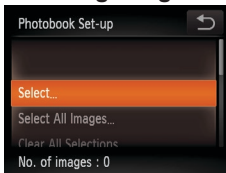

1 Choose [Select].

- Following the procedure in “Choosing a Selection Method” (116), touch [Select] to choose it.





2 Choose an image.

- Drag left or right to browse images, and then touch an image to choose it.
- ▶ [✓] is displayed.
- To remove the image from the photobook, touch the screen again. [✓] is no longer displayed.
- Repeat this process to specify other images.
- When finished, touch [OK] to return to the menu screen.

Still Images

Adding All Images to a Photobook

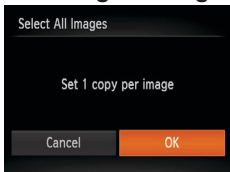

- Following the procedure in “Choosing a Selection Method” (📖 116), touch [Select All Images] to choose it.
- Touch [OK].

Still Images

Removing All Images from a Photobook

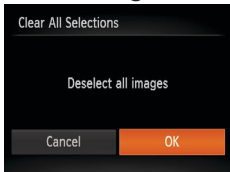

- Following the procedure in “Choosing a Selection Method” (📖 116), touch [Clear All Selections] to choose it.
- Touch [OK].

Cover

Preliminary Notes and Legal Information

Contents: Basic Operations

Basic Guide

Advanced Guide

1 Camera Basics

2 Creative Shot Mode

3 Auto Mode/Hybrid Auto Mode

4 Other Shooting Modes

5 P Mode

6 Playback Mode

7 Wi-Fi Functions

8 Setting Menu

9 Accessories

10 Appendix

Index





10

Appendix

Helpful information when using the camera

| | |
|------------------------------------|-----|
| Troubleshooting | 119 |
| On-Screen Messages | 122 |
| On-Screen Information | 124 |
| Functions and Menu Tables | 126 |
| Handling Precautions | 129 |
| Specifications | 129 |

Cover

Preliminary Notes and
Legal Information

Contents: Basic
Operations

Basic Guide

Advanced Guide

1 Camera Basics

2 Creative Shot
Mode

3 Auto Mode/
Hybrid Auto Mode

4 Other Shooting
Modes

5 P Mode

6 Playback Mode

7 Wi-Fi Functions

8 Setting Menu

9 Accessories

10 Appendix

Index



Troubleshooting

If you think there is a problem with the camera, first check the following. If the items below do not solve your problem, contact a Canon Customer Support Help Desk.

Power

Nothing happens when the ON/OFF button is pressed.

- Confirm that the battery is charged (📖11, 113).
- Confirm that the battery is inserted facing the correct way (📖11).
- Confirm that the memory card cover and battery cover are fully closed (📖11, 13).
- Dirty battery terminals reduce battery performance. Try cleaning the terminals with a cotton swab and reinserting the battery a few times.

The battery is depleted quickly.

- Battery performance decreases at low temperatures. Try warming the battery a little by putting it in your pocket, for example, ensuring that the terminals do not touch any metal objects.
- If these measures do not help and the battery is still depleted soon after charging, it has reached the end of its life. Purchase a new battery.

The lens is not retracted.

- Do not open the memory card cover or battery cover while the camera is on. Close the cover, turn the camera on, and then turn it off again (📖11, 13).

The battery is swollen.

- Battery swelling is normal and does not pose any safety concerns. However, if battery swelling prevents the battery from fitting in the camera, contact a Canon Customer Support Help Desk.

Shooting

Cannot shoot.

- Switch from Playback mode (📖15) to Shooting mode, if necessary, by pressing the <▶> button.

Strange display on the screen under low light (📖29).

Strange display on the screen when shooting.

Note that the following display problems are not recorded in still images but are recorded in movies.

- The screen may darken under bright light.
- The screen may flicker under fluorescent or LED lighting.
- Purplish banding may appear on the screen if you compose a shot that includes a bright light source.

No date stamp is added to images.

- Although date stamps cannot be added to images with this camera, images can be printed with the date as follows.
 - Use the included software to print
For details, refer to the *Software Guide* (📖20).
 - Print using printer functions

[📷] is displayed when the shutter ring is pressed halfway (📖44).

- Set [IS Mode] to [Continuous] (📖63).
- Set the flash mode to [📷] (📖63).
- Increase the ISO speed (📖61).
- Mount the camera on a tripod or take other measures to keep it still. In this case, you should set [IS Mode] to [Off] (📖63).

Shots are out of focus.

- Press the shutter ring halfway to focus on subjects before pressing it all the way down to shoot (📖27).
- Make sure subjects are within focusing range (📖130).
- Set [AF-assist Beam] to [On] (📖51).

Shots are blurry.

- Blurring may occur more often when Touch Shutter is used to shoot, depending on shooting conditions. Hold the camera still when shooting.

No AF frames are displayed and the camera does not focus when the shutter ring is pressed halfway.

- To have AF frames displayed and the camera focus correctly, try composing the shot with higher-contrast subject areas centered before you press the shutter ring halfway. Otherwise, try pressing the shutter ring halfway repeatedly.

Cover

Preliminary Notes and
Legal Information

Contents: Basic
Operations

Basic Guide

Advanced Guide

1 Camera Basics

2 Creative Shot
Mode

3 Auto Mode/
Hybrid Auto Mode

4 Other Shooting
Modes

5 P Mode

6 Playback Mode

7 Wi-Fi Functions

8 Setting Menu

9 Accessories

10 Appendix

Index



Subjects in shots look too dark.

- Set the flash mode to [👉] (📖63).
- Adjust brightness by using exposure compensation (📖60).
- Use spot metering (📖60).

Subjects look too bright, highlights are washed-out.

- Set the flash mode to [👉] (📖44).
- Adjust brightness by using exposure compensation (📖60).
- Use spot metering (📖60).
- Reduce the lighting on subjects.

Shots look too dark despite the flash firing (📖38).

- Shoot within flash range (📖130).
- Increase the ISO speed (📖61).

Subjects in flash shots look too bright, highlights are washed-out.

- Shoot within flash range (📖130).
- Set the flash mode to [👉] (📖44).

White dots or similar image artifacts appear in flash shots.

- This is caused by light from the flash reflecting off dust or airborne particles.

Shots look grainy.

- Lower the ISO speed (📖61).

Subjects are affected by red-eye.

- Edit images using red-eye correction (📖77).

Recording to the memory card takes too long, or continuous shooting is slower.

- Use the camera to perform low-level formatting of the memory card (📖109).

Shooting settings or FUNC. menu settings are not available.

- Available setting items vary by shooting mode. Refer to “Functions Available in Each Shooting Mode”, “FUNC. Menu”, and “Shooting Menu” (📖126 – 127).

The Babies or Children icon does not display.

- The Babies and Children icons will not display if the birthday is not set in face information (📖44). If the icons still do not display even when you set the birthday, re-register face information (📖44), or make sure that the date/time are set correctly (📖106).

Shooting Movies

The elapsed time shown is incorrect, or recording is interrupted.

- Use the camera to format the memory card, or switch to a card that supports high-speed recording. Note that even if the elapsed time display is incorrect, the length of movies on the memory card corresponds to the actual recording time (📖108, 130).

[🔴] is displayed and shooting stops automatically.

The camera's internal memory buffer filled up as the camera could not record to the memory card quickly enough. Try one of the following measures.

- Use the camera to perform low-level formatting of the memory card (📖109).
- Lower the image quality (📖50).
- Switch to a memory card that supports high-speed recording (📖130).

Zooming is not possible.

- Zooming is not possible when shooting movies in [📷] (📖55) and [📷] (📖57) modes.

Playback

Playback is not possible.

- Image or movie playback may not be possible if a computer is used to rename files or alter the folder structure. Refer to the *Software Guide* (📖20) for details on folder structure and file names.

Playback stops, or audio skips.

- Switch to a memory card that you have performed low-level formatting on with the camera (📖109).
- There may be brief interruptions when playing movies copied to memory cards that have slow read speeds.
- When movies are played on a computer, frames may be dropped and audio may skip if computer performance is inadequate.

Cover

Preliminary Notes and
Legal Information

Contents: Basic
Operations

Basic Guide

Advanced Guide

1 Camera Basics

2 Creative Shot
Mode

3 Auto Mode/
Hybrid Auto Mode

4 Other Shooting
Modes

5 P Mode

6 Playback Mode

7 Wi-Fi Functions

8 Setting Menu

9 Accessories

10 Appendix

Index



Sound is not played during movies.

- Adjust the volume (🔊 65) if you have activated [Mute] (🔇 106) or the sound in the movie is faint.
- No sound is played for movies shot in [📹] (📹 55) or [📹] (📹 57) mode because audio is not recorded in these modes.

Memory Card

The memory card is not recognized.

- Restart the camera, with the memory card in it (📷 13).

Wi-Fi

[Wi-Fi] is not displayed, and you cannot access the Wi-Fi menu.

- The Wi-Fi menu is not available in Shooting mode. Switch to Playback mode and try again.
- Touch the screen to switch to simple information display (📷 66).
- [Wi-Fi] will not be displayed, when using magnified display or index display. Switch to single-image display and try again.
- Similarly, [Wi-Fi] cannot be accessed during filtered image display according to specified conditions. Cancel the playback state of the image in image search mode.
- [Wi-Fi] will not be displayed when the camera is connected to a printer or computer with a cable. Disconnect the cable.

Cannot add a device/destination.

- A total of 20 items of connection information can be added to the camera. Erase unneeded connection information from the camera first, and then add new devices/destinations (📷 102).
- E-mail is the only Web service for which multiple accounts can be set. Use CameraWindow to change the desired Web service accounts (📷 89).
- To add a smartphone as a device, first install the dedicated application CameraWindow on your smartphone.
- To add a computer as a device, first install the included software CameraWindow on the computer. Also check your computer and Wi-Fi environment and settings (📷 92, 93).
- Do not use the camera near sources of Wi-Fi signal interference, such as microwave ovens, Bluetooth devices, or other equipment operating on the 2.4 GHz band.

- Bring the camera closer to the other device you are trying to connect to (such as the access point), and make sure there are no objects between the devices.

Cannot send images.

- The destination device has insufficient storage space. Increase the storage space on the destination device and resend the images.
- The write-protect tab of the memory card in the destination camera is set to the locked position. Slide the write-protect tab to the unlocked position.

Cannot resize images for sending.

- Images cannot be resized to be bigger than the resolution setting of their original size.
- Movies cannot be resized.

Images take a long time to send./The Wi-Fi connection is disrupted.

- Multiple images may take a long time to send. Try resizing the image to [M2] or [S] to reduce sending time (📷 99).
- Movies may take a long time to send.
- Do not use the camera near sources of Wi-Fi signal interference, such as microwave ovens, Bluetooth devices, or other equipment operating on the 2.4 GHz band. Note that images may take a long time to send even when [Wi-Fi] is displayed.
- Bring the camera closer to the other device you are trying to connect to (such as the access point), and make sure there are no objects between the devices.
- When sending images to a computer from a memory card with a large amount of images (approximately 1,000), the connection may be disrupted. Import any necessary images to a computer, and then reduce the number of images on the memory card by erasing unnecessary images.

Want to erase Wi-Fi connection information before disposing of the camera or giving it to someone else.

- Reset the Wi-Fi settings (📷 103).

Cover

Preliminary Notes and Legal Information

Contents: Basic Operations

Basic Guide

Advanced Guide

1 Camera Basics

2 Creative Shot Mode

3 Auto Mode/Hybrid Auto Mode

4 Other Shooting Modes

5 P Mode

6 Playback Mode

7 Wi-Fi Functions

8 Setting Menu

9 Accessories

10 Appendix

Index



On-Screen Messages

If an error message is displayed, respond as follows.

No memory card

- The memory card may be inserted facing the wrong way. Reinsert the memory card facing the correct way (📖13).

Cannot record!

- Shooting was attempted without a memory card in the camera. To shoot, insert a memory card facing the correct way (📖13).

Memory card error (📖109)

- If the same error message is displayed even after you have formatted a supported memory card (📖2) and have inserted it facing the correct way, contact a Canon Customer Support Help Desk (📖13).

Insufficient space on card

- There is not enough free space on the memory card to shoot (📖32, 35, 53, 59) or edit images (📖77). Either erase unneeded images (📖72, 73) or insert a memory card with enough free space (📖13).

Touch AF unavailable

- Touch AF is not available in the current shooting mode (📖126).

Touch AF canceled

- The subject selected for Touch AF can no longer be detected (📖43).

Charge the battery (📖11, 113)

No Image.

- The memory card does not contain any images that can be displayed.

Protected!

- It may not be possible to erase images that were protected on other cameras or a computer, to prevent accidental erasure.

Unidentified Image/Incompatible JPEG/Image too large./Cannot play back MOV/Cannot play back MP4

- Unsupported or corrupt images cannot be displayed.

- It may not be possible to display images that were edited or renamed on a computer, or images shot with another camera.

Cannot magnify!/Cannot rotate/Cannot modify image/Cannot modify/ Cannot assign to category/Unselectable image./No identification information

- The following functions may be unavailable for images that were renamed or already edited on a computer, or images shot with another camera. Note that starred (*) functions are not available for movies. Magnify* (📖71), Favorites (📖75), Rotate (📖74), Edit* (📖77), Photobook Set-up* (📖116), and Edit ID Info* (📖70).

Exceeded selection limit

- More than 998 images were selected for Photobook Set-up (📖116). Choose 998 images or less.
- Photobook Set-up (📖116) settings could not be saved correctly. Reduce the number of selected images and try again.
- You attempted to choose more than 500 images in Erase (📖72), Favorites (📖75), or Photobook Set-up (📖116).

Communication error

- An excessive amount of images (approx. 1,000) on the memory card prevented printing or image transfer to a computer. To transfer the images, use a commercially available USB card reader. To print, insert the memory card directly into the printer card slot.

Naming error!

- The folder could not be created or images could not be recorded, because the highest supported folder number (999) for storing images on the card has been reached and the highest supported image number (9999) for images in folders has been reached. Format the memory card (📖108).

Lens Error

- This error may occur if the lens is held while it is moving, or when the camera is used in dusty or sandy locations.
- Frequent display of this error message may indicate camera damage. In this case, contact a Canon Customer Support Help Desk.

Cover

Preliminary Notes and Legal Information

Contents: Basic Operations

Basic Guide

Advanced Guide

1 Camera Basics

2 Creative Shot Mode

3 Auto Mode/ Hybrid Auto Mode

4 Other Shooting Modes

5 P Mode

6 Playback Mode

7 Wi-Fi Functions

8 Setting Menu

9 Accessories

10 Appendix

Index



A camera error was detected (error number)

- If this error message is displayed immediately after a shot, the image may not have been saved. Switch to Playback mode to check for the image.
- Frequent display of this error message may indicate camera damage. In this case, write down the error number (*Exx*) and contact a Canon Customer Support Help Desk.

File Error

- Correct printing (📖115) may not be possible for photos from other cameras or images that have been altered using computer software, even if the camera is connected to the printer.

Print error

- Restart the printer and complete the setting on the camera again.

Ink absorber full

- Contact a Canon Customer Support Help Desk to request assistance with ink absorber replacement.

Wi-Fi

Connection failed

- No access points were recognized. Check the access point settings (📖94).
- A device could not be found. Turn the camera off and on again, and retry the connection.
- Check the device you want to connect to and make sure it is ready for connection.

Cannot determine access point

- The WPS buttons on numerous access points were pressed simultaneously. Try reconnecting again.

No access points found

- Check to make sure that the access point is turned on.
- When connecting to an access point manually, make sure that you entered the correct SSID.

Incorrect Wi-Fi encryption key/Incorrect Wi-Fi security settings

- Check the access point security settings (📖93).

IP address conflict

- Reset the IP address so that it does not conflict with another.

Disconnected/Receiving failed/Sending failed

- You may be in an environment where Wi-Fi signals are obstructed.
- Avoid using the camera's Wi-Fi function around microwave ovens, Bluetooth devices, and other devices that operate on the 2.4 GHz band.
- Bring the camera closer to the other device you are trying to connect to (such as the access point), and make sure there are no objects between the devices.
- Check the connected device to make sure it is not experiencing errors.

Sending failed

Memory card error

- If the same error message is displayed even when you have inserted a formatted memory card facing the correct way, contact a Canon Customer Support Help Desk.

Receiving failed

Insufficient space on card

- There is not enough free space on the memory card to receive images. Erase images to create space on the memory card, or insert a memory card with sufficient space.

Receiving failed

Naming error!

- When the highest folder number (999), and the highest image number (9999) have been reached on the receiving camera, images cannot be received.

Insufficient space on server

- Delete unnecessary images uploaded to CANON IMAGE GATEWAY to create space.
- Save the images sent via a server (📖101) on your computer.

SSL certificate not valid

Connect to a computer, use the supplied software to reset

- Check to make sure the date/time settings on the camera are correct. After confirming that the settings are correct, follow the on-screen instructions and reset the settings.

Check network settings

- Check to make sure your computer can connect to the Internet with the current network settings.

Cover

Preliminary Notes and
Legal Information

Contents: Basic
Operations

Basic Guide

Advanced Guide

1 Camera Basics

2 Creative Shot
Mode

3 Auto Mode/
Hybrid Auto Mode

4 Other Shooting
Modes

5 P Mode

6 Playback Mode

7 Wi-Fi Functions

8 Setting Menu

9 Accessories

10 Appendix

Index



On-Screen Information

Shooting (Information Display)

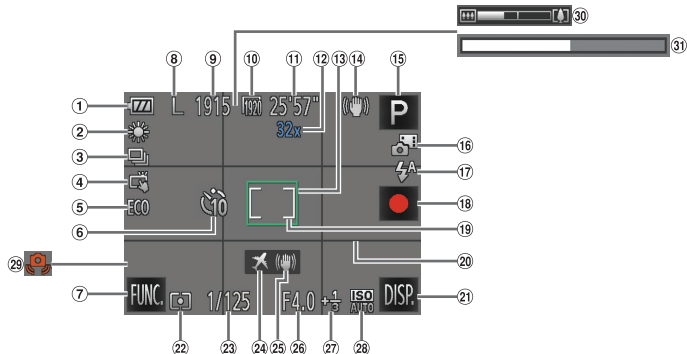

- ① Battery level (124)
- ② White balance (61)
- ③ Drive mode (62)
- ④ Touch Shutter (43)
- ⑤ Eco mode (107)
- ⑥ Self-timer (42)
- ⑦ FUNC. (Function) (29)
- ⑧ Still image resolution (49)
- ⑨ Recordable shots* (130)
- ⑩ Movie resolution (50)
- ⑪ Remaining time (130)
- ⑫ Digital zoom magnification (41)
- ⑬ AF frame (17)
- ⑭ IS mode icon (40)
- ⑮ Shooting mode (126), Scene icon (39)
- ⑯ Hybrid Auto mode (38)
- ⑰ Flash mode (44, 63)
- ⑱ Movie recording (37, 57)
- ⑲ Spot AE point frame (60)
- ⑳ Grid lines (50)
- ㉑ DISP. (Display) (29)
- ㉒ Metering method (60)
- ㉓ Shutter speed
- ㉔ Time zone (106)

- ㉕ Image stabilization (63)
- ㉖ Aperture value
- ㉗ Exposure compensation level (60)
- ㉘ ISO speed (61)
- ㉙ Camera shake warning (38)
- ㉚ Zoom bar (36)
- ㉛ Super slow motion movie (shooting time) (57)

* In [] mode, indicates the number of shots available.

Battery Level

An on-screen icon or message indicates the battery charge level.

| Display | Details |
|----------------------|---|
| | Sufficient charge |
| | Slightly depleted, but sufficient |
| | Nearly depleted—charge the battery soon |
| [Charge the battery] | Depleted—charge the battery immediately |
| | Charging in progress (11) |
| | Charging finished (11) |

Cover

Preliminary Notes and Legal Information

Contents: Basic Operations

Basic Guide

Advanced Guide

1 Camera Basics

2 Creative Shot Mode

3 Auto Mode/Hybrid Auto Mode

4 Other Shooting Modes

5 P Mode

6 Playback Mode

7 Wi-Fi Functions

8 Setting Menu

9 Accessories

10 Appendix

Index



Playback (Detailed Information Display)

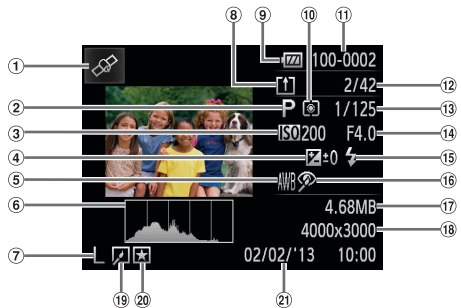

- | | | |
|---|--|----------------------------------|
| ① GPS information display (67) | ⑧ Images have been saved on a computer (101) | ⑯ Red-eye correction (77) |
| ② Shooting mode (126) | ⑨ Battery level (124) | ⑰ File size |
| ③ ISO speed (61), Playback speed (57, 55) | ⑩ Metering method (60) | ⑱ Still images: Resolution (130) |
| ④ Exposure compensation level (60) | ⑪ Folder number - File number | ⑲ Image editing (77) |
| ⑤ White balance (61) | ⑫ Current image no. / Total no. of images | ⑳ Favorites (75) |
| ⑥ Histogram (67) | ⑬ Shutter speed (still images), Image quality / Frame rate (movies) (50) | ㉑ Shooting date/time (13) |
| ⑦ Resolution (49), MOV (movies) | ⑭ Aperture value | |
| | ⑮ Flash (63) | |

Summary of Movie Control Panel in “Viewing” (65)

| | |
|--|---|
| | Touch to display the volume panel, and then touch [][] to adjust the volume. At a volume of 0, [] is displayed. |
| | Play |
| | Skip Backward* or Previous Clip (79) |
| | Previous Frame (For slow-rewind, keep touching this icon.) |
| | Next Frame (For slow-forward, keep touching this icon.) |
| | Skip Forward* or Next Clip (79) |
| | Erase Clip (displayed when a digest movie is selected (79)) |
| | Edit (78) |

* Displays the frame approx. 4 sec. before or after the current frame.



- To switch frames, touch the scrollbar or drag left or right.

Cover

Preliminary Notes and Legal Information

Contents: Basic Operations

Basic Guide

Advanced Guide

1 Camera Basics

2 Creative Shot Mode

3 Auto Mode/ Hybrid Auto Mode

4 Other Shooting Modes

5 P Mode

6 Playback Mode

7 Wi-Fi Functions

8 Setting Menu

9 Accessories

10 Appendix

Index



Functions and Menu Tables

Functions Available in Each Shooting Mode

| Function | Shooting Mode | | | | | | | | | |
|-----------------------------|---------------|----|---|----|----|---|----|----|----|----|
| | | | | | | | | | | |
| Digital Zoom (M41) | – | ○ | ○ | ○ | – | – | – | – | – | – |
| Touch AF (M43) | *1 | – | ○ | *1 | – | – | – | – | *1 | – |
| Touch Shutter (M43) | ○ | *2 | ○ | ○ | *3 | – | *2 | *2 | ○ | *2 |
| Switch Screen Display (M29) | | | | | | | | | | |
| Information Display | ○ | ○ | ○ | ○ | ○ | ○ | ○ | ○ | ○ | ○ |
| No Information Display | ○ | ○ | ○ | ○ | ○ | ○ | ○ | ○ | ○ | ○ |

○ Available or set automatically. – Not available.

*1 The frame is displayed in green when you press the shutter ring halfway, and the focus and brightness level cannot be changed.

*2 The frame is displayed in green when you touch the screen, and the focus and brightness level cannot be changed.

*3 Only available for shooting. Subject designation not available.

FUNC. Menu

| Function | Shooting Mode | | | | | | | | | |
|---------------------------------------|---------------|---|---|---|---|---|---|---|---|---|
| | | | | | | | | | | |
| Metering Method (M60) | | | | | | | | | | |
| | ○ | ○ | ○ | ○ | ○ | ○ | ○ | ○ | ○ | ○ |
| | – | – | – | ○ | – | – | – | – | – | – |
| White Balance (M61) | | | | | | | | | | |
| AWB | ○ | ○ | ○ | ○ | ○ | ○ | ○ | ○ | ○ | ○ |
| | – | – | – | ○ | – | – | – | – | – | – |
| ISO Speed (M61) | | | | | | | | | | |
| ISO AUTO | ○ | ○ | ○ | ○ | ○ | ○ | ○ | ○ | ○ | ○ |
| ISO 80 100 200 400 800 1600 3200 6400 | – | – | – | ○ | – | – | – | – | – | – |
| Flash (M44, 63) | | | | | | | | | | |
| | – | ○ | ○ | ○ | ○ | ○ | ○ | ○ | ○ | – |
| | – | – | – | ○ | ○ | ○ | ○ | ○ | ○ | – |
| | ○ | ○ | ○ | ○ | ○ | ○ | ○ | ○ | ○ | ○ |
| Exposure Compensation (M60) | – | – | – | ○ | ○ | ○ | ○ | ○ | ○ | – |
| Self-Timer (M42) | | | | | | | | | | |
| | ○ | ○ | ○ | ○ | ○ | ○ | ○ | ○ | ○ | ○ |
| Drive Mode (M62) | | | | | | | | | | |
| | ○ | ○ | ○ | ○ | ○ | ○ | ○ | ○ | ○ | ○ |
| | – | – | ○ | – | – | – | – | – | – | – |
| | – | – | – | ○ | ○ | ○ | ○ | ○ | ○ | – |

○ Available or set automatically. – Not available.

Cover

Preliminary Notes and Legal Information

Contents: Basic Operations

Basic Guide

Advanced Guide

1 Camera Basics

2 Creative Shot Mode

3 Auto Mode/Hybrid Auto Mode

4 Other Shooting Modes

5 P Mode

6 Playback Mode

7 Wi-Fi Functions

8 Setting Menu

9 Accessories

10 Appendix

Index



| Shooting Mode | | | | | | | | | | | |
|-------------------------------|--|---|------|---|---|---|----|---|---|---|---|
| Function | | | AUTO | P | | | | | | | |
| Still Image Aspect Ratio (49) | | | | | | | | | | | |
| 16:9 3:2 4:3 1:1 | | - | - | O | O | - | *1 | - | - | O | - |
| Resolution (49) | | | | | | | | | | | |
| L | | O | O | O | O | O | O | O | O | O | O |
| M1 M2 S | | - | O | O | O | - | - | - | - | - | O |
| Movie Quality (50) | | | | | | | | | | | |
| 1920 | | O | O | O | O | O | - | O | O | O | - |
| 1280 640 | | O | O | O | O | O | *2 | O | O | O | - |
| 420 4720 | | - | - | - | - | - | - | - | - | - | O |

O Available or set automatically. – Not available.

*1 Only [4:3] and [16:9] are available.

*2 Synchronizes with the aspect ratio setting and is automatically set (55).

Shooting Menu

| Shooting Mode | | | | | | | | | | | |
|----------------------------------|---------------------------|---|------|---|---|---|---|---|---|---|---|
| Function | | | AUTO | P | | | | | | | |
| Touch Shutter (43) | | | | | | | | | | | |
| On | | O | O | O | O | O | - | O | O | O | O |
| Off | | O | O | O | O | O | O | O | O | O | O |
| AF-assist Beam (51) | | | | | | | | | | | |
| On/Off | | O | O | O | O | O | O | O | O | O | O |
| Review image after shooting (51) | | | | | | | | | | | |
| Display Time | Off/Quick | - | O | O | O | O | O | O | O | O | - |
| | 2 sec./4 sec./8 sec./Hold | O | O | O | O | O | O | O | O | O | - |
| Display Info | Off | O | O | O | O | O | O | O | O | O | - |
| | Detailed | - | O | O | O | O | O | O | O | O | - |
| Grid Lines (50) | | | | | | | | | | | |
| On/Off | | O | O | O | O | O | O | O | O | O | O |
| IS Mode (63) | | | | | | | | | | | |
| Off/Continuous | | O | O | O | O | O | O | O | O | O | O |
| Shoot Only | | - | - | - | O | O | O | O | O | O | - |
| Face ID Settings (44) | | - | O | O | O | O | O | O | O | O | O |

O Available or set automatically. – Not available.

Cover

Preliminary Notes and Legal Information

Contents: Basic Operations

Basic Guide

Advanced Guide

1 Camera Basics

2 Creative Shot Mode

3 Auto Mode/Hybrid Auto Mode

4 Other Shooting Modes

5 P Mode

6 Playback Mode

7 Wi-Fi Functions

8 Setting Menu

9 Accessories

10 Appendix

Index



⚙️ Set up Menu

| Item | Ref. Page | Item | Ref. Page |
|----------------|-----------|--|------------|
| Mute | 📖 106 | Format | 📖 108, 109 |
| Volume | 📖 106 | Units | 📖 109 |
| Date/Time | 📖 13 | Touch Response | 📖 109 |
| Time Zone | 📖 106 | Wi-Fi Settings | 📖 80 |
| Lens Retract | 📖 107 | Mobile Device Connect Button | 📖 85 |
| Eco Mode | 📖 107 | Certification Logo Display | 📖 110 |
| LCD Brightness | 📖 108 | Language  | 📖 15 |
| Color Option | 📖 108 | Reset All | 📖 110 |

▶ Playback Menu

| Item | Ref. Page | Item | Ref. Page |
|--------------------|-----------|-------------------|-----------|
| Erase | 📖 72 | Face ID Info | 📖 68 |
| Rotate | 📖 74 | Group Images | 📖 33 |
| Favorites | 📖 75 | Auto Rotate | 📖 74 |
| Photobook Set-up | 📖 116 | Set Touch Actions | 📖 76 |
| Red-Eye Correction | 📖 77 | | |

▶ Playback Mode FUNC. Menu

| Item | Ref. Page | Item | Ref. Page |
|-----------|-----------|----------------------------|-----------|
| Rotate | 📖 74 | Play Linked Digest Movie*2 | 📖 67 |
| Favorites | 📖 75 | List/Play Digest Movies | 📖 68 |
| Erase | 📖 72 | Image Search | 📖 69 |
| Print*1 | 📖 115 | Slideshow | 📖 72 |

* 1 Shown when the camera is connected to a PictBridge-compatible printer (📖 115).

* 2 Displayed when still images shot in  mode are selected.

Cover

Preliminary Notes and Legal Information

Contents: Basic Operations

Basic Guide

Advanced Guide

1 Camera Basics

2 Creative Shot Mode

3 Auto Mode/Hybrid Auto Mode

4 Other Shooting Modes

5 P Mode

6 Playback Mode

7 Wi-Fi Functions

8 Setting Menu

9 Accessories

10 Appendix

Index



Handling Precautions

- The camera is a high-precision electronic device. Avoid dropping it or subjecting it to strong impact.
- Never bring the camera near magnets, motors, or other devices that generate strong electromagnetic fields, which may cause malfunction or erase image data.
- If water droplets or dirt adheres to the camera or screen, wipe with a dry soft cloth, such as an eyeglass cloth. Do not rub hard or apply force.
- Never use cleaners containing organic solvents to clean the camera or screen.
- Use a blower brush to remove dust from the lens. If cleaning is difficult, contact a Canon Customer Support Help Desk.
- To prevent condensation from forming on the camera after sudden temperature changes (when the camera is transferred from cold to warm environments), put the camera in an airtight, resealable plastic bag and let it gradually adjust to the temperature before removing it from the bag.
- If condensation does form on the camera, stop using it immediately. Continuing to use the camera in this state may damage it. Remove the battery and memory card, and wait until the moisture has evaporated before resuming use.
- Before long-term battery storage, use up the battery's remaining charge, remove it from the camera, and store it in a plastic bag or similar container. Storing a partially charged battery over extended periods (about a year) may shorten its life or affect performance.

Specifications

| | |
|--|---|
| Camera Effective Pixels (Max.) | Approx. 12.1 megapixels |
| Lens Focal Length | 8x zoom: 5.0 (W) – 40.0 (T) mm (35mm film equivalent: 28 (W) – 224 (T) mm) |
| LCD Monitor | 7.1 cm (2.8 in.) color TFT LCD (Touch-screen panel) Effective Pixels: Approx. 461,000 dots |
| File Format | Design rule for Camera File system, DPOF (version 1.1) compliant |
| Data Type | Still Images: Exif 2.3 (JPEG) Movies: MOV (Image data: H.264; Audio data: Linear PCM (monaural)) |
| Interface | Hi-speed USB |
| Wi-Fi Standards | IEEE802.11b/g/n* * 2.4 GHz band only |
| Wi-Fi Transmission Methods | OFDM modulation (IEEE 802.11g/n) DSSS modulation (IEEE 802.11b) |
| Wi-Fi Communication Modes | Infrastructure mode*, Ad hoc mode * Supports Wi-Fi Protected Setup |
| Supported Wi-Fi Channels | 1 – 11 (PC2004) or 1 – 13 (PC1864) Model numbers indicated in parentheses (83) |
| Wi-Fi Security | WEP, WPA-PSK (AES/TKIP), WPA2-PSK (AES/TKIP) |
| Power Source | Battery Pack NB-9L AC Adapter Kit ACK-DC70 |
| Dimensions (Based on CIPA Guidelines) | 78.6 x 60.2 x 29.3 mm (3.09 x 2.37 x 1.15 in.) |
| Weight (Based on CIPA Guidelines) | Approx. 195 g (approx. 6.88 oz.; including the battery and memory card) Approx. 174 g (approx. 6.14 oz.; camera body only) |

Cover

Preliminary Notes and Legal Information

Contents: Basic Operations

Basic Guide

Advanced Guide

1 Camera Basics

2 Creative Shot Mode

3 Auto Mode/ Hybrid Auto Mode

4 Other Shooting Modes

5 P Mode

6 Playback Mode

7 Wi-Fi Functions

8 Setting Menu

9 Accessories

10 Appendix

Index



Number of Shots/Recording Time, Playback Time

| | |
|-------------------------------|----------------------------|
| Number of Shots | Approx. 200 |
| in Eco mode | Approx. 280 |
| Movie Recording Time*1 | Approx. 35 minutes |
| Continuous Shooting*2 | Approx. 1 hour, 10 minutes |
| Playback Time | Approx. 4 hours |

*1 Time under default camera settings, when normal operations are performed, such as shooting, pausing, turning the camera on and off, and zooming.

*2 Time available when shooting the maximum movie length (until recording stops automatically) repeatedly.

- The number of shots that can be taken is based on measurement guidelines of the Camera & Imaging Products Association (CIPA).
- Under some shooting conditions, the number of shots and recording time may be less than mentioned above.
- Number of shots/time with a fully charged battery.

Number of 4:3 Shots per Memory Card

| Recording Pixels | Number of Shots per Memory Card (Approx. shots) | |
|--------------------------------------|---|-------|
| | 4 GB | 16 GB |
| L (Large) 12M/4000x3000 | 1077 | 4338 |
| M1 (Medium 1) 6M/2816x2112 | 1829 | 7362 |
| M2 (Medium 2) 2M/1600x1200 | 6354 | 25574 |
| S (Small) 0.3M/640x480 | 20124 | 80988 |

- The values in the table are measured according to Canon standards and may change depending on the subject, memory card and camera settings.

- The values in the table are based on 4:3 aspect ratio. If the aspect ratio is changed (📖49), more images can be shot because the data size per image will be smaller than with 4:3 images. However, since (M2) 16:9 images have a setting of 1920 x 1080 pixels, their data size will be larger than 4:3 images.

Recording Time per Memory Card

| Image Quality | Recording Time per Memory Card | |
|----------------|--------------------------------|-----------------------|
| | 4 GB | 16 GB |
| L 1920 | 14 min. 32 sec. | 58 min. 38 sec. |
| M1 1280 | 20 min. 41 sec. | 1 hr. 23 min. 26 sec. |
| M2 640 | 43 min. 37 sec. | 2 hr. 55 min. 56 sec. |

- The values in the table are measured according to Canon standards and may change depending on the subject, memory card and camera settings.
- Recording will automatically stop when the clip file size reaches 4 GB, or when the recording time reaches approximately 10 minutes when shooting in (L1920) or (M11280), or approximately 1 hour when shooting in (M2640).
- Recording may stop even if the maximum clip length has not been reached on some memory cards. SD Speed Class 6 or higher memory cards are recommended.

Flash Range

| | |
|-------------------------|----------------------------|
| Maximum wide angle (📷*) | 50 – 90 cm (1.6 – 3.0 ft.) |
|-------------------------|----------------------------|

- Macro scenes (determined by camera): 10 – 50 cm (3.9 in. – 1.6 ft.)
- Peripheral image areas may be dark, depending on subject distance.
- Flash metering may not be activated in some cases when the zoom is set toward telephoto (📷*).

* See step 3 in “Shooting (Smart Auto)” (📖36).

Shooting Range

| | |
|-------------------------|---------------------------|
| Maximum Wide Angle (📷*) | 1 cm (0.4 in.) – infinity |
| Maximum Telephoto (📷*) | 1 m (3.3 ft.) – infinity |

* See step 3 in “Shooting (Smart Auto)” (📖36).

Cover

Preliminary Notes and Legal Information

Contents: Basic Operations

Basic Guide

Advanced Guide

1 Camera Basics

2 Creative Shot Mode

3 Auto Mode/ Hybrid Auto Mode

4 Other Shooting Modes

5 P Mode

6 Playback Mode

7 Wi-Fi Functions

8 Setting Menu

9 Accessories

10 Appendix

Index



Continuous Shooting Speed

Approx. 2.3 shots/sec.

Shutter Speed

| | |
|--------------------------------------|-----------------|
| [AUTO] mode, automatically set range | 1 – 1/2000 sec. |
|--------------------------------------|-----------------|

Battery Pack NB-9L

| | |
|-------------------------|--|
| Type: | Rechargeable lithium-ion battery |
| Nominal Voltage: | 3.5 V DC |
| Nominal Capacity: | 870 mAh |
| Charging Cycles: | Approx. 300 times |
| Operating Temperatures: | 0 – 40 °C (32 – 104 °F) |
| Dimensions: | 14.6 x 43.1 x 15.3 mm (0.57 x 1.70 x 0.60 in.) |
| Weight: | Approx. 21 g (approx. 0.74 oz.) |

Compact Power Adapter CA-DC30/CA-DC30E

| | |
|-------------------------|---|
| Rated Input: | 100 – 240 V AC (50/60 Hz), 7 VA (100 V) – 10 VA (240 V), 0.07 A (100 V) – 0.045 A (240 V) |
| Rated Output: | 5.0 V DC, 0.55 A |
| Charging Time: | Approx. 3 hours (when charging NB-9L in the camera) |
| Operating Temperatures: | 5 – 40 °C (41 – 104 °F) |

Battery Charger CB-2LB/CB-2LBE (Sold Separately)

| | |
|-------------------------|---|
| Rated Input: | 100 – 240 V AC (50/60 Hz), 8.5 VA (100 V) – 12 VA (240 V), 0.085 A (100 V) – 0.05 A (240 V) |
| Rated Output: | 4.2 V DC, 0.7 A |
| Charging Time: | Approx. 1 hr. 50 min. (when using NB-9L) |
| Charge Indicator: | Charging: orange / Fully charged: green (two-indicator system) |
| Operating Temperatures: | 0 – 40 °C (32 – 104 °F) |

- All data is based on tests by Canon.
- Camera specifications or appearance are subject to change without notice.

Cover

Preliminary Notes and
Legal Information

Contents: Basic
Operations

Basic Guide

Advanced Guide

1 Camera Basics

2 Creative Shot
Mode

3 Auto Mode/
Hybrid Auto Mode

4 Other Shooting
Modes

5 P Mode

6 Playback Mode

7 Wi-Fi Functions

8 Setting Menu

9 Accessories

10 Appendix

Index



Index

| | |
|---|----------|
| A | |
| AC adapter kit..... | 112, 113 |
| Accessories..... | 112 |
| Access point | |
| Manual settings..... | 96 |
| Number of display items..... | 96 |
| Adding target devices | |
| Camera..... | 91 |
| Computer..... | 94 |
| Printer..... | 98 |
| Smartphone..... | 85 |
| Web services..... | 89 |
| Aspect ratio..... | 49 |
| Auto mode (shooting mode)..... | 16, 36 |
| B | |
| Batteries → Date/time (date/time battery) | |
| Power saving..... | 26 |
| Battery | |
| Charging..... | 11, 113 |
| Level..... | 124 |
| Power saving..... | 26 |
| Battery charger..... | 112 |
| C | |
| Camera | |
| Adding target devices..... | 91 |
| Nickname..... | 88 |
| Reset all..... | 110 |
| Camera shake..... | 63 |

| | |
|-----------------------------------|-------|
| CameraWindow | |
| Display..... | 97 |
| CANON IMAGE GATEWAY | |
| Settings..... | 89 |
| Color (white balance)..... | 61 |
| Compact power adapter..... | 2, 11 |
| Computer | |
| Adding target devices..... | 94 |
| Environment..... | 92 |
| Preparation..... | 92 |
| Connection | |
| Web services..... | 90 |
| Connection information | |
| Changing nickname..... | 103 |
| Editing..... | 102 |
| Continuous shooting..... | 62 |
| D | |
| Date/time | |
| Changing..... | 14 |
| Date/time battery..... | 15 |
| Settings..... | 13 |
| World clock..... | 106 |
| DC coupler..... | 113 |
| Defaults → Reset all | |
| DIGITAL CAMERA Solution Disk..... | 2 |
| Digital zoom..... | 41 |
| Display language..... | 15 |
| Drag..... | 10 |
| Drive mode..... | 62 |

| | |
|---------------------------------------|----------|
| E | |
| Editing | |
| Red-eye correction..... | 77 |
| Erasing..... | 72, 73 |
| Error messages..... | 122 |
| Exposure | |
| Compensation..... | 60 |
| F | |
| Face ID..... | 44 |
| Favorites..... | 75 |
| Fish-eye effect (shooting mode)..... | 54 |
| Flash | |
| Deactivating flash..... | 44 |
| On..... | 63 |
| Focusing | |
| Touch AF..... | 43 |
| FUNC. menu | |
| Basic operations..... | 29 |
| Table..... | 126, 128 |
| G | |
| GPS..... | 67 |
| Grid lines..... | 50 |
| H | |
| Household power..... | 113 |
| Hybrid Auto mode (shooting mode)..... | 38 |
| I | |
| Images | |
| Display period..... | 51 |
| Erasing..... | 72, 73 |
| Playback → Viewing | |

| | |
|--|----------|
| Indicator..... | 31, 51 |
| Interface cable..... | 2, 21 |
| ISO speed..... | 61 |
| M | |
| MAC address..... | 93 |
| Magnified display..... | 71 |
| Memory cards..... | 2, 88 |
| Recording time..... | 130 |
| Menu | |
| Basic operations..... | 30 |
| Table..... | 126 |
| Metering method..... | 60 |
| microSD/microSDHC/microSDXC memory cards → Memory cards | |
| Miniature effect (shooting mode)..... | 55 |
| Monochrome (shooting mode)..... | 57 |
| Movies | |
| Editing..... | 78 |
| Image quality (resolution/frame rate)..... | 50 |
| Recording time..... | 130 |
| N | |
| Nickname | |
| Camera..... | 88 |
| Device..... | 103 |
| P | |
| Package contents..... | 2 |
| Photobook set-up..... | 116 |
| PictBridge..... | 112, 115 |
| Playback → Viewing | |

Cover

Preliminary Notes and
Legal Information

Contents: Basic
Operations

Basic Guide

Advanced Guide

1 Camera Basics

2 Creative Shot
Mode

3 Auto Mode/
Hybrid Auto Mode

4 Other Shooting
Modes

5 P Mode

6 Playback Mode

7 Wi-Fi Functions

8 Setting Menu

9 Accessories

10 Appendix

Index



| | |
|-------------------------|-----|
| Power → AC adapter kit | |
| → Battery | |
| → Compact power adapter | |
| Power saving | 26 |
| Printing | 115 |
| Program AE | 60 |
| P (shooting mode) | 60 |

R

| | |
|-------------------------------|-----|
| Red-eye correction | 77 |
| Reset all | 110 |
| Resolution (image size) | 49 |
| Rotating | 74 |

S

| | |
|---|----------|
| Saving images to a computer | 97 |
| Screen | |
| Display language | 15 |
| Icons | 124, 125 |
| Menu → FUNC. menu, Menu | |
| Searching | 69 |
| Self-timer | 42 |
| 2-second self-timer | 42 |
| Sending images | 99 |
| Maximum number of images that can be sent together | 99 |
| Resizing images | 99, 100 |
| Sending individually | 99 |
| Sending multiple images | 100 |
| Shooting | |
| Shooting date/time → Date/time | |
| Shooting information | 124 |
| Smartphone | |
| Adding target devices | 85 |

| | |
|---|-------|
| Soft focus (shooting mode) | 56 |
| Software | |
| DIGITAL CAMERA Solution Disk | 2 |
| Installation | 21 |
| Saving images to a computer | 21 |
| Sounds | 106 |
| Strap | 2, 10 |
| Super slow motion movie (movie mode) | 57 |

T

| | |
|--|------------------|
| Terminal | 11, 21, 114, 115 |
| Touch | 10 |
| Touch Actions | 76 |
| Touch AF | 43 |
| Touch-screen panel | 10 |
| Touch Shutter | 43 |
| Toy camera effect (shooting mode) | 56 |
| Traveling with the camera | 106 |
| Troubleshooting | 119 |

V

| | |
|----------------------------|----|
| Viewing | 18 |
| Image search | 69 |
| Index display | 68 |
| Magnified display | 71 |
| Single-image display | 18 |

W

| | |
|-----------------------------|----|
| Web services | |
| Adding target devices | 89 |
| Connection | 90 |
| Display order | 90 |
| White balance (color) | 61 |

| | |
|--------------------------------|------------|
| Wi-Fi | 81 |
| Access point | 93 |
| Resetting Wi-Fi settings | 103 |
| Settings | 93 |
| Windows | |
| CameraWindow display | 97 |
| Settings | 93 |
| World clock | 106 |
| WPS | |
| PBC Method | 95 |
| PIN Method | 96 |
| Wrist strap → Strap | |
| | |
| Zoom | 16, 36, 41 |

Z

| |
|--|
| Cover |
| Preliminary Notes and Legal Information |
| Contents: Basic Operations |
| Basic Guide |
| Advanced Guide |
| 1 Camera Basics |
| 2 Creative Shot Mode |
| 3 Auto Mode/ Hybrid Auto Mode |
| 4 Other Shooting Modes |
| 5 P Mode |
| 6 Playback Mode |
| 7 Wi-Fi Functions |
| 8 Setting Menu |
| 9 Accessories |
| 10 Appendix |
| Index |



CAUTION

RISK OF EXPLOSION IF BATTERY IS REPLACED BY AN INCORRECT TYPE.
DISPOSE OF USED BATTERIES ACCORDING TO LOCAL REGULATION.

Complies with
IDA Standards
DB00671

This product is installed with the WLAN Module which is certified to standards set by IDA Singapore.

Trademark Acknowledgments

- The microSDXC logo is a trademark of SD-3C, LLC.
- This device incorporates exFAT technology licensed from Microsoft.
- Wi-Fi®, Wi-Fi Alliance®, WPA™, WPA2™ and Wi-Fi Protected Setup™ are trademarks or registered trademarks of the Wi-Fi Alliance.

About MPEG-4 Licensing

This product is licensed under AT&T patents for the MPEG-4 standard and may be used for encoding MPEG-4 compliant video and/or decoding MPEG-4 compliant video that was encoded only (1) for a personal and non-commercial purpose or (2) by a video provider licensed under the AT&T patents to provide MPEG-4 compliant video.

No license is granted or implied for any other use for MPEG-4 standard.

Disclaimer

- Reprinting, transmitting, or storing in a retrieval system any part of this guide without the permission of Canon is prohibited.
- Canon reserves the right to change the contents of this guide at any time without prior notice.
- Illustrations and screenshots in this guide may differ slightly from the actual equipment.
- The above items notwithstanding, Canon accepts no liability for damages due to mistaken operation of the products.

Cover

Preliminary Notes and
Legal InformationContents: Basic
Operations

Basic Guide

Advanced Guide

1 Camera Basics

2 Creative Shot
Mode3 Auto Mode/
Hybrid Auto Mode4 Other Shooting
Modes

5 P Mode

6 Playback Mode

7 Wi-Fi Functions

8 Setting Menu

9 Accessories

10 Appendix

Index

