



**LG**

Life's Good

ENGLISH

OWNER'S MANUAL

# MONITOR SIGNAGE

Please read this manual carefully before operating your set and retain it for future reference.

**MONITOR SIGNAGE MODELS**

M2901S

M3801S

[www.lg.com](http://www.lg.com)

**Note**

- Image sticking is a phenomenon that exhibits temporary retained image or permanent "ghost" image, due to the prolonged display of static images, which causes chemical or electrical damage on the display components.
- It is recommended to avoid displaying a fixed static image which is the most common cause of image sticking.
- When a displayed image is not required, it is recommended to display a Dynamic Image, or an Active moving Screen Saver.
- Typical Example of Image Sticking
  - 1) For general usage, such as television broadcasting, image sticking can occur on channel numbers or logos displayed in a fixed position for long periods of time.
  - 2) The displays used at airports and other public transportation stations for displaying customer information, tend to have the same image or similar contents. Image Sticking occurs when this type of format or content is used for a long period of time.
  - 3) Letter box format is consistently used with DVD or VCR.
  - 4) When OSD (On Screen Display) such as "Menu" is consistently present on the screen.
- Power down the product for a period of time that matches that which caused the issue. For example, if image sticking occurred after one hour with certain static image, it will take one hour to eliminate.
- This phenomenon is common to all manufactures and in consequence the manufactures warranty does not cover the product bearing this phenomenon.

<b>Using the Remote Control .....</b>	<b>4</b>
Name of the Remote Control Buttons.....	4
Inserting batteries into remote control. ....	4
<b>Name and Function of the Parts .....</b>	<b>5</b>
Rear View.....	5
<b>Connecting to External Devices.....</b>	<b>6</b>
When Connecting to your PC.....	6
When using the LAN.....	7
Daisy Chain Monitors .....	8
VESA FDMI wall Mounting .....	9
<b>User Menus .....</b>	<b>10</b>
Screen Adjustment options.....	10
OSD Menu .....	12
How to adjust the OSD (On Screen Display) screen .....	12
How to adjust the screen automatically .....	12
Adjusting Screen Color.....	13
Adjusting the Time function .....	15
Adjusting OSD image .....	17
Selecting the UTILITY .....	18
Adjusting UTILITY .....	19
<b>Troubleshooting .....</b>	<b>20</b>
<b>Specifications .....</b>	<b>23</b>
<b>Controlling the Multiple Product.....</b>	<b>A1</b>

# Using the Remote Control

## ● Name of the Remote Control Buttons

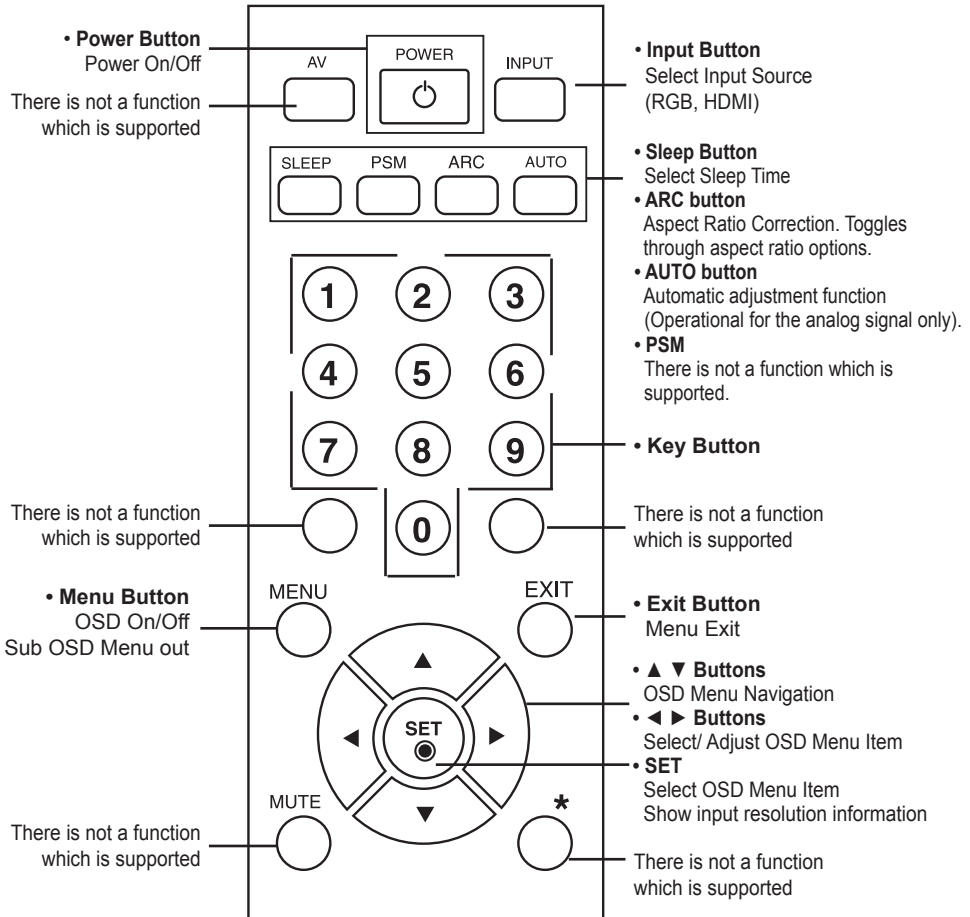

## ● Inserting batteries into remote control.

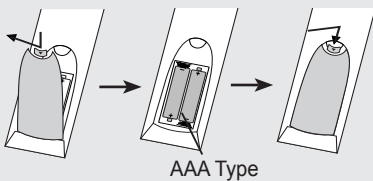

1. Open the battery compartment cover on the back side and install the batteries matching correct polarity (+ with +, - with -)
2. Install two 1.5 V AAA batteries. Don't mix old or used batteries with new ones.
3. Close cover.
4. To remove the batteries, perform the installation actions in reverse.

# Name and Function of the Parts

\* The product image in the user's guide could be different from the actual image.

## ● Rear View

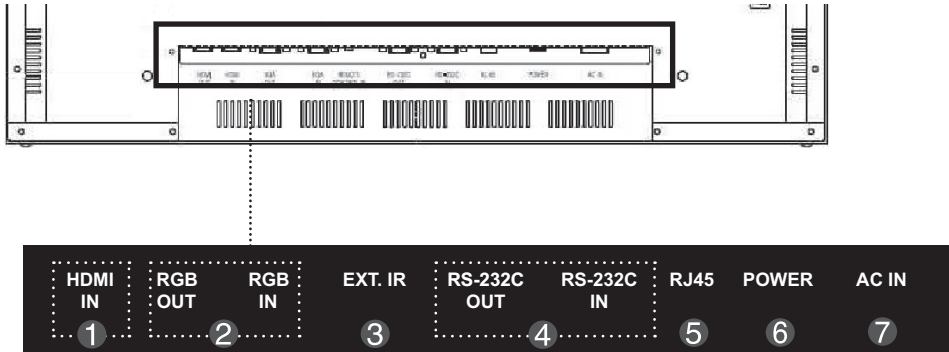

- ① **HDMI IN Ports** : HDMI signal to HDMI port with HDMI cable.
- ② **RGB IN/OUT** : RGB signal to RGB port with RGB cable.
- ③ **EXT. IR** : External IR
- ④ **RS-232C Serial IN/OUT Port** : Connect to the RS-232C port on a PC. For control the another set, connect a RS-232C Cable from RS-232C out port to another set's RS-232C input port.
- ⑤ **RJ45(eZNET) Port** : Connect the LAN cable for eZNET Manager control.
- ⑥ **Power Switch** : AC Power On/Off Switch
- ⑦ **AC Power Connector** : Connect the power cord

# Connecting to External Devices

## ● When Connecting to your PC

- 1 First of all, see if the computer, product and the peripherals are turned off. Then, connect the signal input cable.

- A When connecting with the D-Sub signal input cable.



- B When connecting with the HDMI signal input cable (not included).

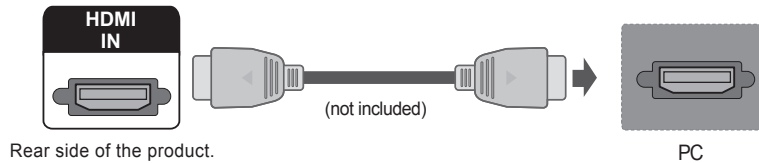

- C When connecting with the HDMI to DVI signal input cable (not included).

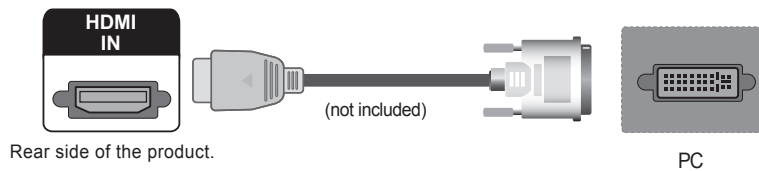

- 2 Connect the power cord.

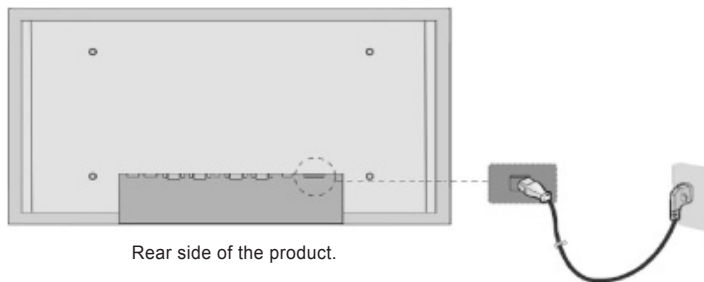

### Note

- If HDMI signal of input device is abnormal, Something wrong phenomenon or no signal can happen on screen.

# Connecting to External Devices

- ③ ① Turn on power by pressing the power button on the product.

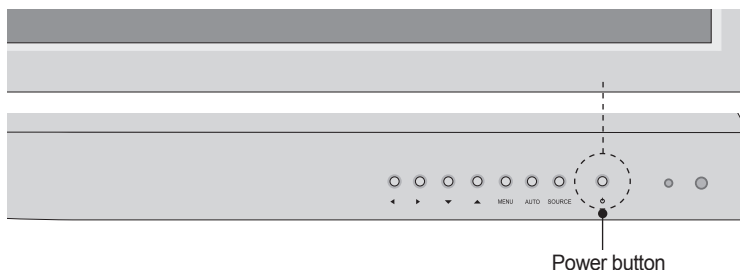

- ② Turn on the PC.

To change input source

Press the SOURCE button on the remote control to select the input signal.

Or, press the SOURCE button on the bottom of the product.

HDMI signal ↔ D-sub signal

## When using the LAN

- ① Connect the LAN cable as shown in the below figure .

- Ⓐ When connecting with a PC.

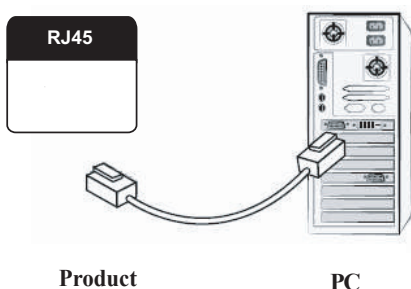

- Ⓑ When connecting with a Network.

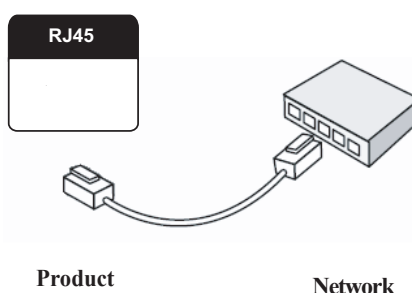

- ② Connect the LAN cable and install the eZ-Net Manager program on the CD-ROM. For more information about the program, please refer to eZ-Net Guide in the enclosed CD-ROM.

# Connecting to External Devices

## ● Daisy Chain Monitors

Use this function when displaying ANALOG RGB inputs of a PC to the other product.

- To use different products connected to each other

Connect one end of the signal input cable(15-pin D-Sub Signal Cable) to the RGB OUT connector of product 1 and connect the other RGB IN connector of other products.

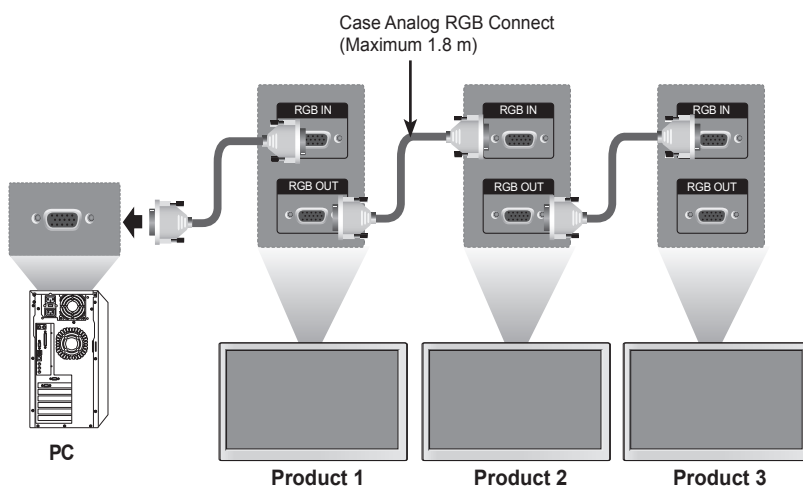



# Connecting to External Devices

## ● VESA FDMI wall Mounting

This product supports a VESA FDMI compliant mounting interface. These mounts are Purchased separately and not available. Refer to the instructions included with the mount for more info

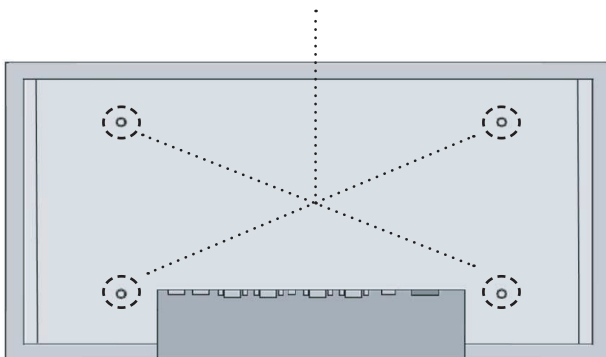

# User Menus

## ● Screen Adjustment options

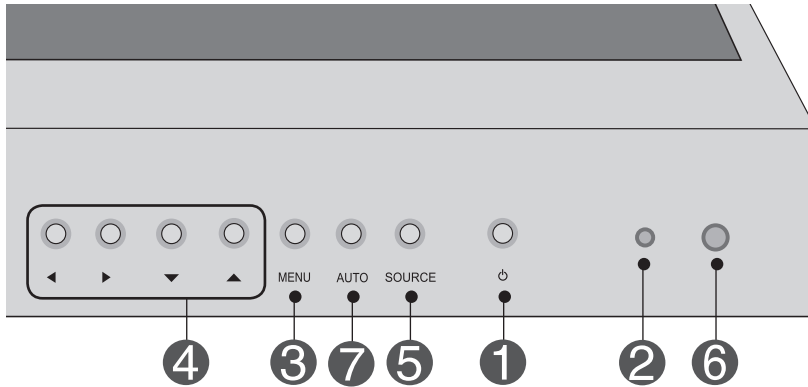

- 
- 1 Power Button** • Press this button to turn on the power. Press this button again to turn it off.
- 
- 2 Power Indicator** • This Indicator lights up green when the display operates normally (on mode). If the display is in sleep (Energy Saving) mode, this indicator color changes to red.
- 
- 3 MENU Button** • Use this button to show/hide the OSD (On Screen Display) menu screen.
- 
- 4 OSD Select / Adjust Button** • Use this button to select an icon or adjust the setting in the OSD screen.
- ▼▲ OSD Menu Navigation up and down
- ▼ : Aspect Ratio Hot key (TOP → Bottom → Stretch)
- 
- ◀▶ ◀ : Select Menu Item, Decrement Value  
▶ : Select Menu Item, Increment Value
-

# User Menus

## ● Screen Adjustment options

---

5

### SOURCE Button

• To change input source depending on connected signal.

Press the SOURCE button on the remote control to select the input signal. Or, press the SOURCE button on the bottom of the product.

HDMI signal ↔ D-Sub Signal

6

### IR Receiver

• This is where the unit receives signals from the remote control.

---

7

### Auto Config

• Automatic adjustment function.(Operational for the analog signal only)

---

# User Menus

## OSD Menu



PICTURE

Adjusts screen brightness, contrast and color that you prefer.



TIME

Adjusts the timer options



OSD

Adjusts the OSD menu position.



UTILITY

Adjusts Set ID and Set Network.



Note

### OSD(On Screen Display)

The OSD function enables you to adjust the screen status conveniently since it provides graphical presentation.

## How to adjust the OSD (On Screen Display) screen

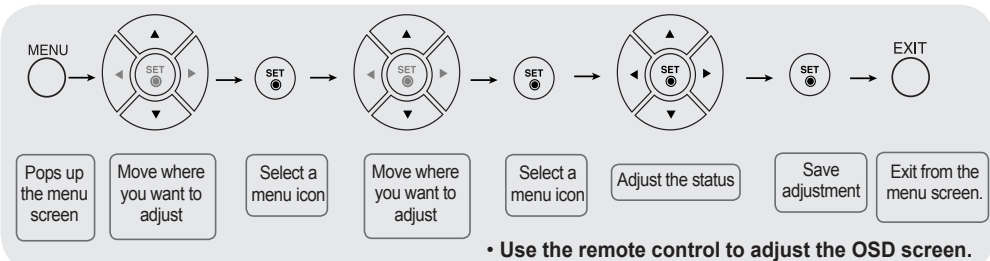

- 1 Press the **MENU** Button, then the main menu of the OSD appears.
- 2 To access a control, use the Buttons.
- 3 When the icon you want becomes highlighted, press the Button.
- 4 Use the Buttons to adjust the item to the desired level.
- 5 Accept the changes by pressing the **SET** Button.
- 6 Exit the OSD by pressing the **EXIT** Button.

## How to adjust the screen automatically

Press the AUTO button on a remote Control in the PC analog signal. Then optimal screen settings will be selected that fit into the current mode. If adjustment is not satisfactory, you can adjust the screen manually.

Auto Config

# User Menus



## Adjusting Screen Color

### Picture Mode

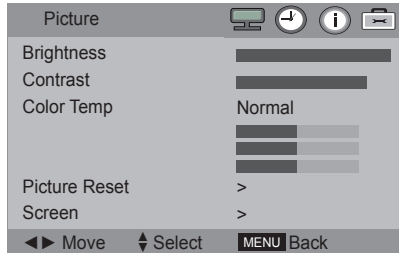

**Brightness** To adjust the brightness of the screen.

**Contrast** Adjust the difference between the light and dark levels in the picture.

**Color Temp** Color Settings

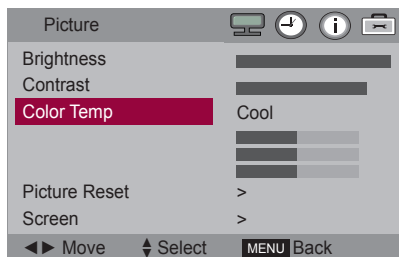

- **Normal** : Slightly bluish white.
- **Cool** : Slightly purplish white.
- **Warm** : Slightly reddish white.
- **User** : Select this option to use the user-defined settings.

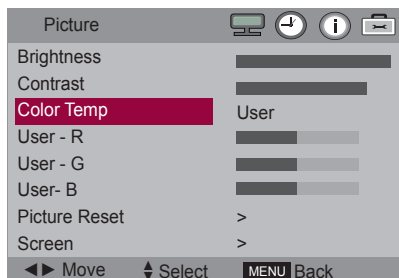

### Red / Green / Blue

Set your own color levels.

# User Menus



## Adjusting Screen Color

**Picture Reset** Return **Picture Mode**, **Color Temp** to the default factory Settings.

**Screen** Adjust the screen video.

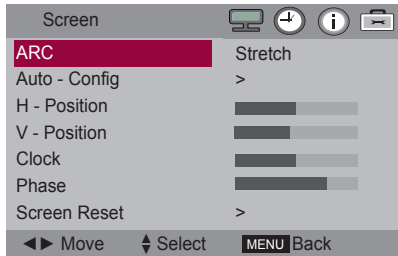

**ARC** To select the image of the screen.(TOP Bottom Stretch)  
(**M2901S** : Case input resolution 1360 x 768)  
TOP : It's composed of 480 line from 1 line of Vertical.  
Bottom : It's composed of 768 line from 481 line of Vertical.  
(**M3801S** : Case input resolution 1920 x 1080)  
TOP : It's composed of 502 line from 1 line of Vertical.  
Bottom : It's composed of 1080 line from 503 line of Vertical.

**XGA Mode** (RGB PC input only) : For more improved pr better picture quality, select the same mode corresponding to computer resolution.

**Auto-Config** (RGB PC input only) : This button is for the automatic adjustment of the screen position, clock and phase. This function is available for analog signals only.

**H-Position** (RGB PC input only) : Moving the screen position horizontally.

**V-Position** (RGB PC input only) : Moving the screen position vertically.

**Clock** (RGB PC input only) : To minimize any vertical bars or stripes visible on the screen background. The horizontal screen size will also change. This function is available for analog signals only.

**Phase** (RGB PC input only) : To adjust the focus of the display. This item allows you to remove any horizontal noise and clear or sharpen the image of characters. This function is available for analog signals only.

**Screen Reset** Return Screen Mode to the default factory Settings.



### Note

- In Stretch/Bottom Mode, Something wrong phenomenon can happen on screen. (ex : Horizontal stripes noise)
- Stretch Mode is mode for service.

# User Menus



## Adjusting the Time function

Time					
Clock Hour	00				
Clock Minute	00				
Week Day	FRI				
On/Off Timer	>				
Sleep Time	Off				
Auto Sleep	Off				
Power Saving	>				
Move		Select	MENU Back		

- Clock Hour** If the current time is incorrect, reset the clock manually.  
Press the the ◀ ▶ button to set the hour(00 to 23).
- Clock Minute** If the current time is incorrect, reset the clock manually.  
Press the the ◀ ▶ button to set the minutes(00 to 59).
- Week Day** If the current day is incorrect, reset the day manually.  
Press the the ◀ ▶ button to set the day(MON, TUE, WED, THU, FRI, SAT, SUN).
- On/Off Timer** The off time automatically switches the set to standby at the pre-set time.

ON / OFF TIMER					
Schedule	Everyday				
On Hour	00				
On Minute	00				
On Timer Enable	Off				
Off Hour	00				
Off Minute	00				
Off Timer Enable	Off				
Move		Select	MENU Back		

- **Schedule** : Use the user-defined settings.  
(Everyday, MON, TUE, WED, THU, FRI, SAT, SUN).
- **On Hour** : Use the user-defined settings.(00 to 23)
- **On Minute** : Use the user-defined settings.(00 to 59)
- **On Timer Enable** : Use the user-defined settings.(On, Off)
- **Off Hour** : Use the user-defined settings.(00 to 23)
- **Off Minute** : Use the user-defined settings .(00 to 59)
- **Off Timer Enable** : Use the user-defined settings.(On, Off)



### Note

- In the event of power interruption (disconnection or power failure), the clock must be reset.
- Once the on or off time is set, these functions operate daily at the preset time.
- Off time function overrides On time function if they are set to the same time.
- When On time is operated, input screen is turned on as it was turned off.

# User Menus



## Adjusting the Time function

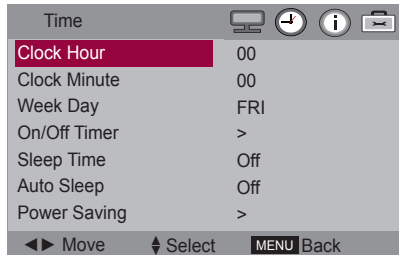

**Sleep Time** The power is automatically turned off when the time set by a user is passed. Press the the ◀ ▶ button to set the time(Off, 10, 20, 30, 60, 90, 120, 180, 240).

**Auto Sleep** If Auto Sleep is active and there is no input signal, the set switches to off mode automatically after about 10 sec.  
ON : Automatically turn the product On/Off at preset times.  
OFF : Disable the On/Off Time function.

**Power Saving** This screen brightness adjusting menu helps you save energy.

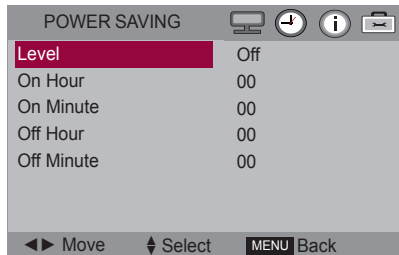

- **Level** : Total 4 screen brightness levels are provided.
  - Off : 100% light
  - Level 1 : 80% light
  - Level 2 : 60% light
  - Level 3 : 40% light
- **On Hour** : Use the user-defined settings.(00 to 23)
- **On Minute** : Use the user-defined settings.(00 to 59)
- **Off Hour** : Use the user-defined settings.(00 to 23)
- **Off Minute** : Use the user-defined settings.(00 to 59)

\* On/Off Hour and Minute: Enables to automatically turn on/off the power saving option at a scheduled time.

\* The power saving option becomes in effect only during the scheduled time frame.



# User Menus



## Adjusting OSD image

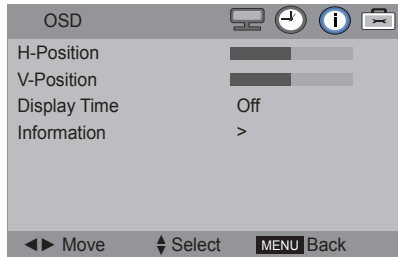

**H-Position** Moving the OSD screen position horizontally.

**V-Position** Moving the OSD screen position vertically.

**Display Time** To set the period of time that the OSD is displayed on the screen.  
(Available times : Off, 15, 30, 45, 60second.)

**Information** This menu shows the input source and software version of the product.

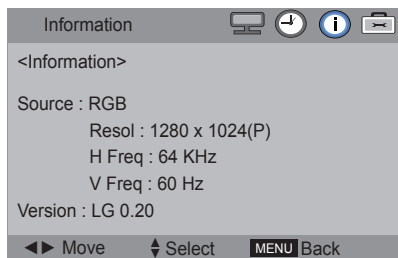

# User Menus



## Selecting the UTILITY

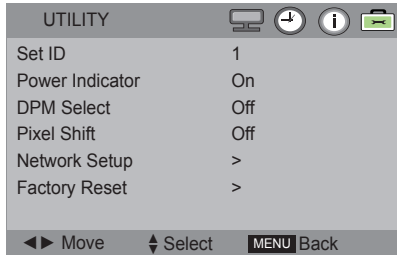

**Set ID** You can assign a unique Set ID NO (name assignment) to each product when several products are connected for display. Specify the number (1 to 99) using the ◀ ▶ button and exit. Use the assigned Set ID to individually control each product using the Product Control Program.

**Power Indicator** Use the function to the set power indicator on the front side of the product to On or Off.

**DPM Select** A user can choose to turn the power saving mode on/off.

**Pixel Shift** A user can choose to turn function.

**Network Setup** Setup network information.

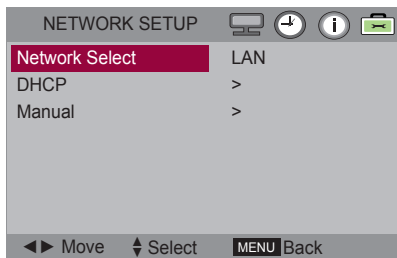

- **Network Select** : Sets up network connections.
  - RS-232 : Enable communication via Serial.
  - LAN : Enable communication via Ethernet.
- **DHCP** : Allocates and sets up IP automatically.
- **Manual** : Sets up IP address, Gateway, Subnet Mask, Primary DNS and Secondary DNS.  
The setup process is complete when you select Execute, and "IP Setup Completed" is displayed at the bottom of the screen. While "Wait for IP Setup" is displayed, you cannot use the local keys and remote control. "Wait for IP Setup" is displayed for up to 40seconds.

# User Menus



## Adjusting UTILITY

MANUAL SETTING	
IP Address	192. 168. 000 .010
Subnet Mask	255. 255. 255. 000
Default Gateway	192. 168. 000. 001
Primary DNS	192. 168. 000. 001
Secondary DNS	192. 168. 000. 001
Execute	>

◀ Move    ↕ Select    MENU Back

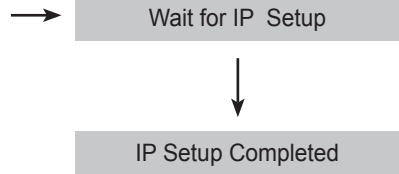

\*If Network Select is set to Serial, DHCP and Manual are disabled.

**Factory Reset**    Select this option to return to the default factory settings.

# Troubleshooting

## No image is displayed

- |  |   |
|--|---|
| <ul style="list-style-type: none"><li>• Is the product power cord connected?</li><li>• Is the power indicator light on?</li><li>• Power is on, power indicator is green but the screen appears extremely dark.</li><li>• The power indicator Red?</li><li>• Does the 'Out of range' message appear?</li><li>• Does the 'no signal' message appear?</li></ul> | <ul style="list-style-type: none"><li>• See if the power cord is properly connected to the outlet.</li><li>• See if the power switch is turned on.</li><li>• May need service.</li><li>• Adjust brightness and contrast again.</li><li>• Backlight may need repair.</li><li>• If the product is in power saving mode, move the mouse or press any key.</li><li>• Turn both devices off and then back on.</li><li>• The signal from the PC (video card) is out of the vertical or horizontal frequency range of the product. Adjust the frequency range by referring to the Specifications in this manual.<ul style="list-style-type: none"><li>* <b>Maximum resolution</b></li><li><b>M2901S</b> RGB : 1360 x 768 @ 60 Hz<br/>HDMI/DVI : 1360 x 768 @ 60 Hz</li><li><b>M3801S</b> RGB : 1920 x 1080 @ 60 Hz<br/>HDMI/DVI : 1920 x 1080 @ 60 Hz</li></ul></li><li>• The signal cable between PC and product is not connected. Check the signal cable.</li><li>• Press the 'SOURCE' menu in the remote Control to check the input signal.</li></ul> |
|--|---|

## 'Unknown Product' message appears when the product is connected.

- |   |   |
|---|---|
| <ul style="list-style-type: none"><li>• Did you install the driver?</li></ul> | <ul style="list-style-type: none"><li>• Install the product driver, which is provided with the product, or download it from the web site. (<a href="http://www.lg.com">http://www.lg.com</a>)</li></ul> |
|---|---|

# Troubleshooting

## The screen image looks abnormal.

- **Is the screen position wrong?**
  - D-Sub analog signal - Press the "AUTO" button in the remote control to automatically select the optimal screen status that fits into the current mode. If adjustment is not satisfactory, use the Position OSD menu.
  - See if the video card resolution and frequency are supported by the product. If the frequency is out of range, set to the recommended resolution in the Control Panel - Display - Setting menu.
- **Do thin lines appear on the background screen?**
  - D-Sub analog signal - Press the "AUTO" button in the remote control to automatically select an optimal screen status that fits into the current mode. If adjustment is not satisfactory, use the Clock OSD menu.
- **Horizontal noise appears or the characters look blurred.**
  - D-Sub analog signal - Press the "AUTO" button in the remote control to automatically select an optimal screen status that fits into the current mode. If adjustment is not satisfactory, use the Phase OSD menu.
- **The screen is displayed abnormally.**
  - The proper input signal is not connected to the signal port. Connect the signal cable that matches with the source input signal.

## After-image appears on the product.

- **After-image appears when the product is turned off.**
  - If you use a fixed image for a long time, the pixels may be damaged quickly. Use the screen-saver function.

# Troubleshooting

## Screen color is abnormal.

- Screen has poor color resolution (16 colors).
  - Set the number of colors to more than 24 bits (true color)  
Select Control Panel - Display - Settings - Color Table menu in Windows.
- Screen color is unstable or mono-colored.
  - Check the connection status of the signal cable. Or, re-insert the PC video card.
- Do black spots appear on the screen?
  - Several pixels (red, green, white or black color) may appear on the screen, which can be attributable to the unique characteristics of the LCD panel. It is not a malfunction of the LCD.

## After-image appears on the product.

- The power suddenly turned off.
  - Is the sleep timer set?
  - Check the power control settings.  
Power interrupted.
  - "CAUTION! FAN STOP!"  
If the power is turned off after this message appears, it means that the fan is out of order.  
In this case, contact your local service center.

# Specifications

The product specifications can change without prior notice for product improvement.

## M2901S

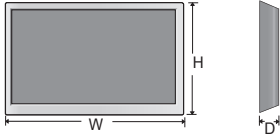
<b>LCD Panel</b>	73.91 cm (29.1 inch) TFT (Thin Film Transistor) LCD (Liquid Crystal Display) Panel 0.1703 mm x RGB x 0.5108 mm (Pixel Pitch)	
<b>Power</b>	<b>Rated Voltage</b>	AC 100-240 V~ 50 / 60 Hz 3 A (Max.)
	<b>Power Consumption</b>	On Mode : 90 W (Max.) DPMS Mode : ≤ 3.0 W (Max.) SW-OFF Mode : ≤ 0.5 W Off Mode : ≤ 0.3 W
<b>Dimensions &amp; Weight</b>		
	<b>Width x Height x Depth</b>	
	76.34 cm (30.05 inch) x 30.58 cm (12.03 inch) x 8.55 cm (3.36 inch)	
	<b>Net</b>	11.0 kg (24.25 lb)
<b>Video Signal</b>	<b>Max. Resolution</b>	RGB : 1360 x 768 @ 60 Hz HDMI/DVI : 1366 x 768 @ 60 Hz - It may not be supported depending on the OS or video card type.
	<b>Recommended Resolution</b>	RGB : 1366 x 768 @ 60 Hz HDMI/DVI : 1366 x 768 @ 60 Hz - It may not be supported depending on the OS or video card type.
	<b>Horizontal Frequency</b>	RGB : 28 kHz to 70 kHz HDMI/DVI : 28 kHz to 70 kHz
	<b>Vertical Frequency</b>	RGB : 57 Hz to 63 Hz HDMI/DVI : 57 Hz to 63 Hz
	<b>Synchronization Type</b>	Separate/Digital
<b>Input Connector</b>	15-pin D-Sub type, HDMI (digital), RS-232C, LAN	
<b>Environmental Conditions</b>	<b>Operational Condition</b>	Temperature: 5 °C to 35 °C , Humidity: 10 % to 80 %
	<b>Storage Condition</b>	Temperature: -20 °C to 60 °C , Humidity: 5 % to 90 %

### NOTE

- Information in this document is subject to change without notice.

# Specifications

The product specifications can change without prior notice for product improvement.

## M3801S

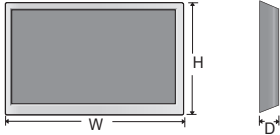
<b>LCD Panel</b>	96.26 cm (37.9 inch) TFT (Thin Film Transistor) LCD (Liquid Crystal Display) Panel 0.4845 mm x RGB x 0.4845 mm (Pixel Pitch)	
<b>Power</b>	<b>Rated Voltage</b>	AC 100-240 V~ 50 / 60 Hz 3 A (Max.)
	<b>Power Consumption</b>	On Mode : 110 W (Max.) DPM Mode : ≤ 3.0 W (Max.) SW-OFF Mode : ≤ 0.5 W Off Mode : ≤ 0.3 W
<b>Dimensions &amp; Weight</b>		
	<b>Width x Height x Depth</b>	98.64 cm (38.83 inch) x 29.94 cm (11.78 inch) x 9.0 cm (3.54 inch)
	<b>Net</b>	13.8 kg (30.42 lb)
<b>Video Signal</b>	<b>Max. Resolution</b>	RGB : 1920 x 1080 @ 60 Hz HDMI/DVI : 1920 x 1080 @ 60 Hz - It may not be supported depending on the OS or video card type.
	<b>Recommended Resolution</b>	RGB : 1920 x 1080 @ 60 Hz HDMI/DVI : 1920 x 1080 @ 60 Hz - It may not be supported depending on the OS or video card type.
	<b>Horizontal Frequency</b>	RGB : 28 kHz to 70 kHz HDMI/DVI : 28 kHz to 70 kHz
	<b>Vertical Frequency</b>	RGB : 57 Hz to 63 Hz HDMI/DVI : 57 Hz to 63 Hz
	<b>Synchronization Type</b>	Separate/Digital
<b>Input Connector</b>	15-pin D-Sub type, HDMI (digital), RS-232C, LAN	
<b>Environmental Conditions</b>	<b>Operational Condition</b>	Temperature: 5 °C to 35 °C , Humidity: 10 % to 80 %
	<b>Storage Condition</b>	Temperature: -20 °C to 60 °C , Humidity: 5 % to 90 %

### NOTE

- Information in this document is subject to change without notice.



# Specifications

## ● PC Mode - Preset Mode

### M2901S

Preset mode		Horizontal Frequency (kHz)	Vertical Frequency (Hz)	Preset mode		Horizontal Frequency (kHz)	Vertical Frequency (Hz)
1	640 x 480	31.469	59.94	9	1280 x 720	45.0	60.0
2	720 x 400	31.468	70.08	10	1280 x 960	60.0	60.0
3	800 x 600	37.354	59.861	11	1360 X 480	29.934	59.988
4	800 x 600	37.879	60.317	12	1360 x 768	47.72	59.799
5	1024 x 768	47.816	59.92	13	1360 x 768	47.712	60.015
6	1024 x 768	48.363	60.004	14	1366 x 768	47.13	59.66
7	1152 x 864	54.348	60.053	15	1280 x 1024	63.668	59.895
8	1280 x 720	44.772	59.856	16	1280 x 1024	63.981	60.02

\* 5, 6, 12 to 14 Select Resolution In SCREEN XGA Mode Menu

### M3801S

Preset mode		Horizontal Frequency (kHz)	Vertical Frequency (Hz)	Preset mode		Horizontal Frequency (kHz)	Vertical Frequency (Hz)
1	640 x 480	31.469	59.94	10	1280 x 720	44.772	59.856
2	720 x 400	31.468	70.08	11	1280 x 960	60.0	60.0
3	720 x 400	31.5	70.156	12	1360 x 768	47.72	59.799
4	800 x 600	37.354	59.861	13	1360 x 768	47.712	60.015
5	800 x 600	37.879	60.317	14	1366 x 768	47.13	59.66
6	1024 x 768	47.816	59.92	15	1280 x 1024	63.668	59.895
7	1024 x 768	48.363	60.004	16	1280 x 1024	63.981	60.02
8	1920 x 502	31.25	59.981	17	1920 x 1080	66.587	59.934
9	1152 x 864	54.348	60.053	18	1920 x 1080	67.5	60.0

\* 6, 7, 12 to 14 Select Resolution In SCREEN XGA Mode Menu

## ● Power Indicator

Mode	On Mode	DPM Mode	SW-OFF Mode	Off Mode
Product	Green	Red	Red	-

- Use this method to connect several products to a single PC. You can control several products at a time by connecting them to a single PC.

## Connecting the cable

- Connect the RS-232C cable as shown in the picture.

- The RS-232C protocol is used for communication between the PC and product. You can turn the product on/off, select an input source or adjust the OSD menu from your PC.

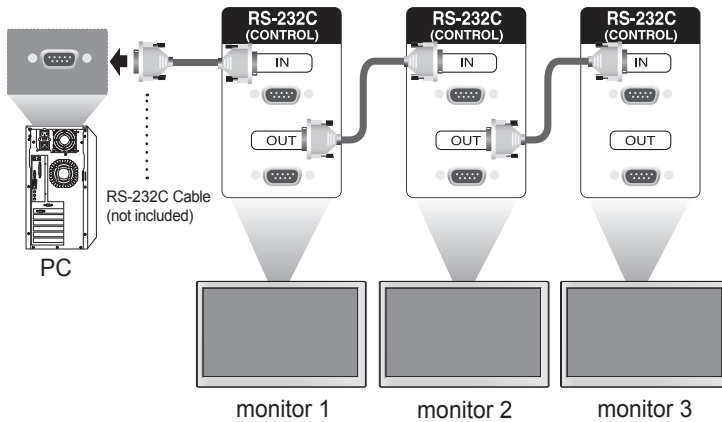

## RS-232C Configurations

### 7-Wire Configurations (Standard RS-232C cable)

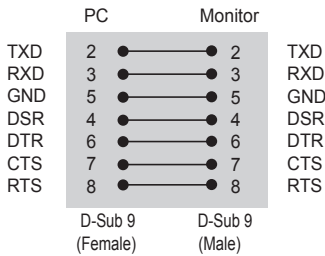

### 3-Wire Configurations (Not Standard RS-232C cable)

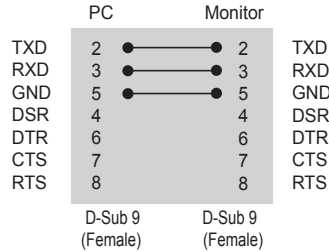

## Communication Parameter

- ▶ Baud Rate : 9600 baud Rate (UART)
- ▶ Data Length : 8 bit
- ▶ Parity Bit : None
- ▶ Stop Bit : 1bit
- ▶ Flow Control : None
- ▶ Communication Code : ASCII code
- ▶ Use a crossed (reverse) cable

 Command Reference List

	COMMAND1	COMMAND2	DATA1	DATA2	DATA3
1. Power	k	a	00 or 01		
Power	k	a	FF		
2. Input Select	k	b	07 or 09		
3. Input Select	x	b	60 or a0		
4. Aspect Ratio	k	c	0a to 0c		
5. Contrast	k	g	00 to 64		
6. Brightness	k	h	00 to 64		
7. OSD Select	k	l	00 or 01		
8. Remote / key Lock	k	m	00 or 01		
9. Color Temp	k	u	00 to 03		
10. User-Red Adjust	k	v	00 to 3c		
11. User-Green Adjust	k	w	00 to 3c		
12. User-Blue Adjust	k	\$	00 to 3c		
13. Abnormal state	k	z	FF		
14. Auto Configuration	j	u	01		
15. Lamp Fault check	d	p	FF		
16. Time	f	a	00 to 06	00 to 17	00 to 3B
17. On Timer On/Off	f	b	00 or FF	00 to FF	
18. Off Timer On/Off	f	c	00 or FF	00 to FF	
19. On Timer Time	f	d	00 to 07	00 to 17	00 to 3B
20. Off Timer Time	f	e	00 to 07	00 to 17	00 to 3B
21. Sleep Time	f	f	00 to 08		
22. Auto Sleep	f	g	00 to 01		
23. DPM Select	f	j	00 to 01		
24. Reset	f	k	00 to 02		
25. Power Saving	f	l	00 to 03		
26. Power Indicator	f	o	00 or 01		
27. H-Position	f	q	00 to 64		
28. V-Position	f	r	00 to 64		
29. Serial No.	f	y	FF		
30. S/W Version	f	z	FF		
31. Product Type	f	v	FF		
32. Model Name	f	w	FF		

Note 1: [Data] 0: Monday, 1: Tuesday, ... , 6: Sunday, (7: Everyday)

[Data1] 00 to 23 Hours

[Data2] 00 to 59 Minutes

Note 2: [Data] 0: Write, FF: Read

[Data1] bit0: Monday Timer On(1)/Off(0), ... , bit7: Everyday Timer On(1)/Off(0)

## ● Transmission / Receiving Protocol

### Transmission

```
[Command1][Command2][ ][Set ID][ ][Data][Cr] or
[Command1][Command2][ ][Set ID][ ][Data] [ ][Data1][Cr] or
[Command1][Command2][ ][Set ID][ ][Data] [ ][Data1][ ][Data2][Cr]
```

\* [Command1]: First Command. (d, f, j, k)

\* [Command2]: Second command.

\* [Set ID]: Set up the Set ID number of product.

Range: 1 to 63[HEX]. By setting '0', server can control is all products.

In case of operating with more than 2 sets using set ID as '0' at the same time, it should not be checked the ACK message. Because all sets will send the ACK message, so it's impossible the check the whole ACK messages.

\* [Data]: To transmit command data.

Transmit 'FF' data to read status of command.

\* [Cr]: Carriage Return. ASCII code '0 x 0D'

\* [ ]: Space. ASCII code '0 x 20'

### OK Acknowledgement

```
[Command2][ ][Set ID][ ][OK][Data][x] or
[Command2][ ][Set ID][ ][OK][Data][Data1][x] or
[Command2][ ][Set ID][ ][OK][Data][Data1][Data2][x]
```

\* The Product transmits ACK (acknowledgement) based on this format when receiving normal data. At this time, if the data is data read mode, it indicates present status data. If the data is data write mode, it returns the data of the PC computer.

### Error Acknowledgement

```
[Command2][ ][Set ID][ ][NG][Data][x]
```

\* If there is error, it returns NG

## ● Transmission / Receiving Protocol

### 01. Power(Command : a)

- ▶ To control Power On / Off of the Set.

#### Transmission

```
[k][a][Set ID][Data][Cr]
```

Data 00 : Power Off

#### Acknowledgement

```
[a][Set ID][OK][Data][x]
```

01 : Power On

- ▶ To show the status of Power On / Off.

#### Transmission

```
[k][a][Set ID][Data][Cr]
```

Data : FF

#### Acknowledgement

```
[a][Set ID][OK][Data][x]
```

Data 00 : Power Off 01 : Power On 09 : DPM

### 02. Input Select(Command : k b)(Main Picture Input)

- ▶ To select input source for the Set.  
You can also select an input source using the INPUT button on the remote control.

#### Transmission

```
[k][b][Set ID][Data][Cr]
```

Data 07 : RGB(PC) 09 : HDMI(PC)

#### Acknowledgement

```
[b][Set ID][OK][Data][x]
```

### 03. Input Select(Command : x b)

- ▶ To select input source for the Set.

#### Transmission

```
[x][b][Set ID][Data][Cr]
```

Data 60 : RGB(PC) a0 : HDMI(PC)

#### Acknowledgement

```
[b][Set ID][OK][Data][x]
```

### 04. Aspect Ratio(Command : k c) (Main picture format)

- ▶ To adjust the screen format.  
You can also adjust the screen format using the ARC(Aspect Ratio Control) button on remote control or in the Screen menu.

#### Transmission

```
[k][c][Set ID][Data][Cr]
```

Data 0a : Top 0b : Bottom 0c : Stretch

#### Acknowledgement

```
[c][Set ID][OK][Data][x]
```

### 05. Contrast(Command : k g)

- ▶ To adjust screen contrast.  
You can also adjust the contrast in the Picture menu.

#### Transmission

```
[k][g][Set ID][Data][Cr]
```

Data Min : 00 to Max : 64

\* Real data mapping 0 : step 0, ..., a : step 10, ..., 64 : step 100

#### Acknowledgement

```
[g][Set ID][OK][Data][x]
```

## ● Transmission / Receiving Protocol

### 06. Brightness(Command : k h)

- ▶ To adjust screen brightness.  
You can also adjust the brightness in the Picture menu.

#### Transmission

```
[k][h][Set ID][Data][Cr]
```

Data Min : 00 to Max : 64

\* Real data mapping 0 : step 0, ..., a : step 10, ..., 64 : step 100

#### Acknowledgement

```
[h][Set ID][OK][Data][x]
```

### 07. OSD Select(Command : k l)

- ▶ To control OSD on/off to the set.

#### Transmission

```
[k][l][Set ID][Data][Cr]
```

Data 00 : OSD Off 01 : OSD On

#### Acknowledgement

```
[l][Set ID][OK][Data][x]
```

### 08. Remote/Key Lock(Command : k m)

- ▶ To control Remote Lock on/off to the set.  
This function, when controlling RS-232C, locks the remote control and the local keys.

#### Transmission

```
[k][m][Set ID][Data][Cr]
```

Data 00 : Off 01 : On

#### Acknowledgement

```
[m][Set ID][OK][Data][x]
```

### 09. Color Temperature(Command : k u)

- ▶ To adjust the screen color temperature.

#### Transmission

```
[k][u][Set ID][Data][Cr]
```

Data 00 : Normal 01 : Cool 02 : Warm 03 : User

#### Acknowledgement

```
[u][Set ID][OK][Data][x]
```

### 10. Color Temperature User-RED Adjust(Command : k v)

- ▶ To adjust the screen user red color temperature.

#### Transmission

```
[k][v][Set ID][Data][Cr]
```

Data Min : 00 to Max : 3c

\* Real data mapping 00 : -30, ..., 1e : 0, ..., 3c : 30

#### Acknowledgement

```
[v][Set ID][OK][Data][x]
```

## ● Transmission / Receiving Protocol

### 11. Color Temperature User-Green Adjust(Command : k w)

▶ To adjust the screen user green color temperature.

Transmission

[k][w][Set ID][Data][Cr]

Acknowledgement

[w][Set ID][OK][Data][x]

Data Min : 00 to Max : 3c

\* Real data mapping 00 : -30, ..., 1e : 0, ..., 3c : 30

### 12. Color Temperature User-Blue Adjust(Command : k \$)

▶ To adjust the screen user Blue color temperature.

Transmission

[k][\$][Set ID][Data][Cr]

Acknowledgement

[\$][Set ID][OK][Data][x]

Data Min : 00 to Max : 3c

\* Real data mapping 00 : -30, ..., 1e : 0, ..., 3c : 30

### 13. Abnormal state(Command : k z)

▶ Abnormal State : Used to Read the power off status when Stand-by mode.

Transmission

[k][z][Set ID][Data][Cr]

Acknowledgement

[z][Set ID][OK][Data][x]

Data FF : Read

- 00 : Normal (Power on and signal exist)
- 01 : No signal
- 02 : Turn the monitor off by remote control
- 03 : Turn the monitor off by sleep time function
- 04 : Turn the monitor off by RS-232C function
- 08 : Turn the monitor off by off time function
- 09 : Turn the monitor off by auto sleep function

### 14. Auto Configuration(Command: j u)

▶ To adjust picture position and minimize image shaking automatically. it works only in RGB(PC) mode.

Transmission

[j][u][Set ID][Data][Cr]

Acknowledgement

[u][Set ID][OK][Data][x]

Data 01 : To set

### 15. Lamp fault Check(Command : d p)

▶ To check lamp fault.

Transmission

[d][p][Set ID][Data][Cr]

Acknowledgement

[p][Set ID][OK][Data][x]

\* The data is always FF(in Hex).

Data 00 : Lamp Fault 01: Lamp OK

## ● Transmission / Receiving Protocol

### 16. Time(Command : f a)

▶ Set the current time.

#### Transmission

```
[f][a][Set ID][Data1][Data2][Data3][Cr]
```

#### [Data1]

0 : Monday  
1 : Tuesday  
2 : Wednesday  
3 : Thursday  
4 : Friday  
5 : Saturday  
6 : Sunday

#### [Data2]

00 H to 17 H : 00 to 23 Hours

#### [Data3]

00 H to 3 BH : 00 to 59 Minutes

#### Acknowledgement

```
[a][Set ID][OK/NG][Data1][Data2][Data3][x]
```

\* When reading data, FFH is inputted for [Data1], [Data2] and [Data3].  
In other cases, all are treated as NG.

### 17. On Timer On/Off(Command : f b)

▶ Set days for On Timer.

#### Transmission

```
[f][b][Set ID][Data1][Data2][Cr]
```

#### [Data1]

0 (Write), FFH(Read)

#### [Data2]

00 H to FFH  
bit0 : Monday On Timer On(1), Off(0)  
bit1 : Tuesday On Timer On(1), Off(0)  
bit2 : Wednesday On Timer On(1), Off(0)  
bit3 : Thursday On Timer On(1), Off(0)  
bit4 : Friday On Timer On(1), Off(0)  
bit5 : Saturday On Timer On(1), Off(0)  
bit6 : Sunday On Timer On(1), Off(0)  
bit7 : Everyday On Timer On(1), Off(0)

#### Acknowledgement

```
[b][Set ID][OK/NG][Data1][Data2][x]
```



## ● Transmission / Receiving Protocol

### 18. Off Timer On/Off (Command : f c)

- ▶ Set days for Off Timer.

#### Transmission

[f][c][Set ID][Data1][Data2][Cr]
----------------------------------

#### Acknowledgement

[c][Set ID][OK/NG][Data1][Data2][x]
-------------------------------------

#### [Data1]

0 (Write), FFH(Read)

#### [Data2]

00 H to FFH

- bit0 : Monday Off Timer On(1), Off(0)
- bit1 : Tuesday Off Timer On(1), Off(0)
- bit2 : Wednesday Off Timer On(1), Off(0)
- bit3 : Thursday Off Timer On(1), Off(0)
- bit4 : Friday Off Timer On(1), Off(0)
- bit5 : Saturday Off Timer On(1), Off(0)
- bit6 : Sunday Off Timer On(1), Off(0)
- bit7 : Everyday Off Timer On(1), Off(0)

### 19. On Timer Time(Command : f d)

- ▶ Set On Timer.

#### Transmission

[f][d][Set ID][Data1][Data2][Data3][Cr]
---

#### Acknowledgement

[b][Set ID][OK/NG][Data1][Data2][Data3][x]
--

#### [Data1]

- 0 : Monday
- 1 : Tuesday
- 2 : Wednesday
- 3 : Thursday
- 4 : Friday
- 5 : Saturday
- 6 : Sunday
- 7 : Everyday

#### [Data2]

00 H to 17 H : 00 to 23 Hours

#### [Data3]

00 H to 3 BH : 00 to 59 Minutes

\* When reading data, FFH is inputted for [Data1], [Data2] and [Data3].  
In other cases, all are treated as NG.

## ● Transmission / Receiving Protocol

### 20. Off Timer Time(Command : f e)

▶ Set Off Timer.

Transmission

[f][e][Set ID][Data1][Data2][Data3][Cr]

Acknowledgement

[e][Set ID][OK/NG][Data1][Data2][Data3][x]

[Data1]

- 0 : Monday
- 1 : Tuesday
- 2 : Wednesday
- 3 : Thursday
- 4 : Friday
- 5 : Saturday
- 6 : Sunday
- 7 : Everyday

[Data2]

00 H to 17 H : 00 to 23 Hours

[Data3]

00 H to 3 BH : 00 to 59 Minutes

### 21. Sleep Time(Command : f f)

▶ Set Sleep Timer.

Transmission

[f][f][Set ID][Data][Cr]

Acknowledgement

[f][Set ID][OK/NG][Data][x]

[Data]

- 0 : Off
- 1 : 10
- 2 : 20
- 3 : 30
- 4 : 60
- 5 : 90
- 6 : 120
- 7 : 180
- 8 : 240

### 22. Auto Sleep(Command : f g)

▶ Set Auto Sleep.

Transmission

[f][g][Set ID][Data][Cr]

Acknowledgement

[g][Set ID][OK/NG][Data][x]

[Data] 00 : Off 01 : On

## ● Transmission / Receiving Protocol

### 23. DPM Select(Command : f j)

- ▶ Set the DPM (Display Power Management) function.

#### Transmission

```
[f][j][Set ID][Data][Cr]
```

[Data] 00 : Off 01 : On

#### Acknowledgement

```
[j][Set ID][OK/NG][Data][x]
```

### 24. Reset(Command : f k)

- ▶ Execute the Picture, Screen and Factory Reset functions.

#### Transmission

```
[f][k][Set ID][Data][Cr]
```

[Data]

- 0 : Picture Reset
- 1 : Screen Reset
- 2 : Factory Reset

#### Acknowledgement

```
[k][Set ID][OK/NG][Data][x]
```

### 25. Power saving(Command : f l)

- ▶ To set the Power saving mode.

#### Transmission

```
[f][l][Set ID][Data][Cr]
```

[Data]

- 0 : Off
- 1: (static level 1)
- 2: (static level 2)
- 3: (static level 3)

#### Acknowledgement

```
[l][Set ID][OK/NG][Data][x]
```

### 26. Power Indicator (Command : f o)

- ▶ To set the LED for Power Indicator.

#### Transmission

```
[f][o][Set ID][Data][Cr]
```

[Data] 0 : Off 1 : On

#### Acknowledgement

```
[o][Set ID][OK/NG][Data][x]
```

## ● Transmission / Receiving Protocol

### 27. H-Position (Command : f q)

- ▶ To set the Horizontal position

#### Transmission

```
[f][q][Set ID][Data][Cr]
```

\* The data range is from 00 to 64(in Hex)

#### Acknowledgement

```
[q][Set ID][OK/NG][Data][x]
```

### 28. V-Position (Command : f r)

- ▶ To set the Vertical position.

#### Transmission

```
[f][r][Set ID][Data][Cr]
```

\* The data range is from 00 to 64(in Hex)

#### Acknowledgement

```
[r][Set ID][OK/NG][Data][x]
```

### 29. Serial No.(Command : f y)

- ▶ To read the serial numbers.

#### Transmission

```
[f][y][Set ID][Data][Cr]
```

Data FF (to read the serial numbers)

#### Acknowledgement

```
[y][Set ID][OK/NG][Data][x]
```

### 30. S/W Version(Command : f z)

- ▶ Check the software version.

#### Transmission

```
[f][z][Set ID][Data][Cr]
```

Data FFH : Read

#### Acknowledgement

```
[z][Set ID][OK/NG][Data][x]
```

### 31. Product Type(Command : f v)

- ▶ Check the product type.

#### Transmission

```
[f][v][Set ID][Data][Cr]
```

Data FFH : Read

#### Acknowledgement

```
[v][Set ID][OK/NG][Data][x]
```

### 32. Model Name(Command : f w)

- ▶ Check the model name.

#### Transmission

```
[f][w][Set ID][Data][Cr]
```

Data FFH : Read

#### Acknowledgement

```
[w][Set ID][OK/NG][Data][x]
```

How to connect

- ▶ Connect your wired remote control to Remote Control port on the Product.

Remote Control IR Code

▶ **Output waveform**

single pulse, modulated with 37.917 kHz signal at 455 kHz

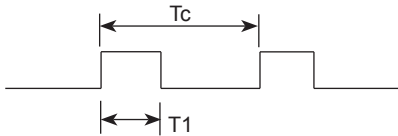

Carrier frequency

$$FCAR = 1 / Tc = fosc / 12$$

$$\text{Duty ratio} = T1 / Tc = 1 / 3$$

▶ **Configuration of frame**

- 1st frame

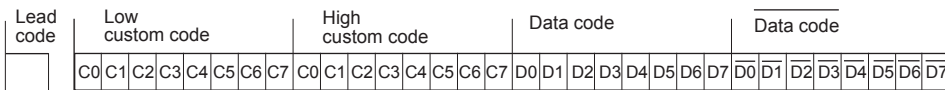

- Repeat frame

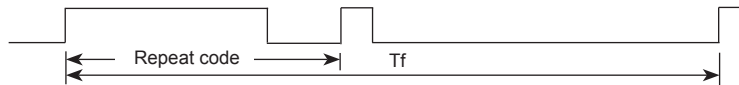

▶ **Lead code**

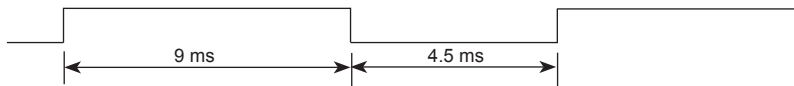

▶ **Repeat code**

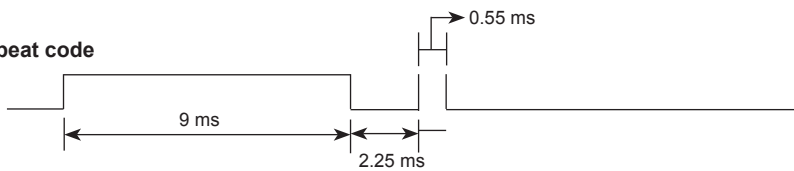

▶ **Bit description**

- Bit "0"

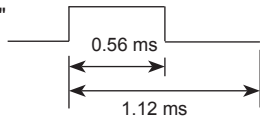

- Bit "1"

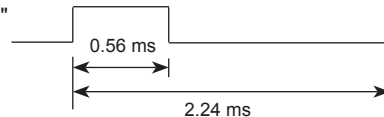

▶ **Frame interval : Tf**

- The waveform is transmitted as long as a key is depressed.

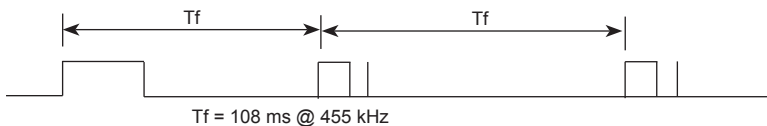

	Code(Hexa)	Function	Note
1	08H	POWER	Soft Power On/Off
2	0BH	INPUT	Input Source Select Menu Open
3	0EH	SLEEP	Sleep Time Control
4	0DH	ARC	Aspect Ratio Correction. (Top, Bottom, Stretch)
5	54H	AUTO	Auto Configuration (RGB Input Only)
6	10H	0	R/C Button
7	11H	1	R/C Button
8	12H	2	R/C Button
9	13H	3	R/C Button
10	14H	4	R/C Button
11	15H	5	R/C Button
12	16H	6	R/C Button
13	17H	7	R/C Button
14	18H	8	R/C Button
15	19H	9	R/C Button
16	43H	MENU	Main Menu On/Off
17	5BH	EXIT	Menu Exit
18	00H	Up(▲)	Menu Navigation
19	01H	Down(▼)	Menu Navigation
20	03H	Left(◀)	Decrement Value, Select menu item
21	02H	Right(▶)	Increment Value, Select menu item



Make sure to read the Safety Precautions before using the product. Keep the Owner's Manual(CD) in an accessible place for future reference. The model and serial number of the SET is located on the back and one side of the SET. Record it below should you ever need service.

MODEL \_\_\_\_\_

SERIAL \_\_\_\_\_

**Important**

WARRANTY VOID  
IF REMOVED

Warranty void if removed.

**WARNING** -This is a class A product. In a domestic environment this product may cause radio interference in which case the user may be required to take adequate measures.

Temporary noise is normal when powering ON or OFF this device.