



HP DesignJet T2500 Multifunction Series

User guide

Legal notices

The information contained herein is subject to change without notice.

The only warranties for HP products and services are set forth in the express warranty statement accompanying such products and services. Nothing herein should be construed as constituting an additional warranty. HP shall not be liable for technical or editorial errors or omissions contained herein.



Hi-Speed USB certified



IPv6-ready

Trademarks

Adobe®, Acrobat®, Adobe Photoshop®, and PostScript® are trademarks of Adobe Systems Incorporated.

Corel® is a trademark or registered trademark of Corel Corporation or Corel Corporation Limited.

ENERGY STAR and the ENERGY STAR mark are registered U.S. trademarks.

Microsoft® and Windows® are U.S. registered trademarks of Microsoft Corporation.

PANTONE® is Pantone, Inc.'s check-standard trademark for color.

Table of contents

1 Introduction	1
Safety precautions	2
HP Start-Up Kit	3
Using this guide	3
Printer models	4
The printer's main features	5
The printer's main components	6
The front panel	8
Printer software	11
Mobile printing	12
Turn the printer on and off	13
The printer's internal prints	13
2 Installing the software	15
Connect the printer to your network	16
Connect a computer to the printer by network (Windows)	17
Uninstall the printer software (Windows)	18
Connect a computer to the printer by network (Mac OS X)	18
Uninstall the printer software (Mac OS X)	19
3 Setting up the printer	20
Introduction	21
Set up web services	21
Web Services manual configuration	21
Configure a scan-to-network or scan-to-FTP folder	23
Paper suitability options	28
Turn nesting on and off	29
Turn usage information on and off	30
Turn e-mail notifications on and off	31
Turn alerts on and off	31
Control access to the printer	32

Require account ID	33
Set Windows driver preferences	34
4 Network configuration	35
Introduction	36
Verify correct operation	36
Preconfigure network settings if required	36
Add the printer to your network system	37
Troubleshooting	37
Reset network parameters	38
Control network protocols	39
Front-panel menu items	39
Embedded services	43
Supported network protocols	44
5 Personalizing the printer	45
Change the language of the front-panel display	46
Access the HP Utility	46
Access the Embedded Web Server	46
Change the language of the HP Utility	47
Change the language of the Embedded Web Server	47
Change the sleep mode setting	47
Change the auto-off setting	47
Change the loudspeaker volume	48
Change the front-panel display brightness	48
Change the units of measurement	48
Configure network settings	48
Change the graphic language setting	49
Manage printer security	50
Change your printer's email address	50
6 Paper handling	51
General advice	52
Load a roll onto the spindle	52
Load a roll into the printer	55
Unload a roll	58
Load a single sheet	59
The stacker	60
The basket	63
View information about the paper	63

Paper presets	64
Printing paper info	64
Move the paper	65
Maintain paper	65
Change the drying time	65
Change the retrieval time	65
Turn the automatic cutter on and off	66
Feed and cut the paper	66
7 Working with two rolls	67
The uses of a multiroll printer	67
How the printer allocates jobs to paper rolls	67
8 Printing	69
Introduction	70
Print from a USB flash drive	70
Print from a computer using the Embedded Web Server or HP Utility	71
Print from a computer using a printer driver	73
Advanced print settings	73
Print from iOS with AirPrint	84
9 Scanning	86
Paper types suitable for scanning	86
Scan to file	87
10 Copying	90
11 Mobile printing	92
Introduction	93
Print from mobile devices	93
Print from Apple iOS	93
Print from Android	93
Print by email (HP ePrint)	93
Mobile Printing	94
12 Job queue management	95
The job queue in the front panel	96
The job queue in the Embedded Web Server or HP Utility	99

13 Color management	103
Introduction	104
How colors are represented	104
A summary of the color management process	104
Color calibration	104
Color management from printer drivers	106
Color management from printer drivers (PostScript printers)	109
Color management from the Embedded Web Server	112
Color management from the front panel	113
Color management and the scanner	113
14 Practical printing examples	115
Print from Adobe Acrobat	116
Print from Autodesk AutoCAD	118
Print from Adobe Photoshop	123
Print and scale from Microsoft Office	125
15 Retrieving printer usage information	132
Get printer accounting information	133
Check usage statistics	133
Check usage statistics for a job	133
Request accounting data by email	134
16 Handling ink cartridges and printhead	136
About the ink cartridges	137
Check the ink cartridges status	137
Remove an ink cartridge	137
Insert an ink cartridge	138
Safe mode	140
About the printhead	140
Check the printhead status	140
Remove the printhead	141
Insert the printhead	145
Storage of anonymous usage information	148
17 Printer maintenance	149
Check printer status	150
Clean the exterior of the printer	150
Maintain the ink cartridges	150
Move or store the printer	150

Update the firmware	151
Update the software	152
Printer maintenance kits	152
Secure File Erase	153
Disk Wipe	153
18 Scanner maintenance	154
Clean the scanner's glass plate	155
Replace the scanner's glass plate	158
Calibrate the scanner	163
19 Supplies and accessories	165
How to order supplies and accessories	166
Introduction to the accessories	167
20 Troubleshooting paper issues	168
The paper cannot be loaded successfully	169
The paper type is not in the list	170
The printer printed on the wrong paper type	171
An "on hold for paper" message	171
The paper has jammed in the print platen	173
The paper has jammed in the stacker	177
The printer reports unexpectedly that the stacker is full	177
The printer displays out of paper when paper is available	177
Prints do not fall neatly into the basket	177
The print remains in the printer after printing has completed	178
The cutter does not cut well	178
The roll is loose on the spindle	178
21 Troubleshooting print-quality issues	179
General advice	181
Print-quality troubleshooting wizard	181
Recalibrate the paper advance	182
Horizontal lines across the image (banding)	183
Lines are too thick, too thin or missing	184
Lines appear stepped or jagged	185
Lines print double or in the wrong colors	185
Lines are discontinuous	186
Lines are blurred	186
Line lengths are inaccurate	187

The whole image is blurry or grainy	187
The paper is not flat	188
The print is scuffed or scratched	188
Ink marks on the paper	189
Black ink comes off when you touch the print	190
Edges of objects are stepped or not sharp	190
Edges of objects are darker than expected	190
Horizontal lines at the end of a cut sheet print	191
Vertical bands of different colors	191
White spots on the print	191
Colors are inaccurate	191
Colors are fading	192
The image is incomplete (clipped at the bottom)	192
The image is clipped	193
Some objects are missing from the printed image	193
A PDF file is clipped or objects are missing	194
The Image Diagnostics Print	194
If you still have a problem	196

22 Troubleshooting scanner issues 198

Cannot access the network folder	198
Scanning to file is slow	198

23 Troubleshooting scan-quality issues 200

Random vertical lines	201
Wrinkles or folds	201
Line discontinuities	202
Grain in area fills when scanning plain paper	203
Small color differences between adjacent CIS modules	204
Vertical light lines at the intersection between CIS modules	205
Variable line thickness or missing lines	206
Inaccurately reproduced colors	206
Color fringing	207
Clipping in dark or light areas	208
Flare in the image when scanning glossy originals	209
Vertical red and green bands over white or black background	209
The stop-start effect	210
Vibration	211
Horizontal periodical banding	211
Defocus, blurring and fading colors	212
Incorrect paper advance, skew during scanning, or horizontal wrinkles	213

Vertical black band 20 cm wide	214
The scanner damages some originals	215
Completely wrong colors	215
Vertical distortion	216
Object replication (ghosting)	216
Clipping or incorrect scale factor when down-scaling in copies and prints	217
Incorrect edge detection, mostly when scanning tracing paper	218
A copied or scanned image is very skewed	218
24 The scanner diagnostic plot	219
Prepare the printer and the paper to print the diagnostic sheet	220
Visual check for errors while printing the diagnostic sheet	220
Scan or copy the diagnostic plot	224
Monitor calibration	224
Save the diagnostic plot for future use	225
25 Troubleshooting ink cartridge and printhead issues	226
Cannot insert an ink cartridge	227
Ink cartridge status messages	227
Cannot insert the printhead	227
The front-panel display recommends reseating or replacing the printhead	227
Clean the printhead	228
Align the printhead	228
Printhead status messages	229
26 Troubleshooting general printer issues	230
The printer will not start	231
The printer does not print	231
The printer seems slow	232
The printer behaves strangely	232
Communication failures between computer and printer	232
Cannot access the HP Utility	233
Cannot access the Embedded Web Server	233
Cannot connect to the Internet	233
Mobile printing troubleshooting	234
Automatic file system check	234
Alerts	235
27 Front-panel error messages	236
The system error log	239

28 HP Customer Care	240
Introduction	241
HP Professional Services	241
HP Proactive Support	242
Customer Self Repair	242
Contact HP Support	243
29 Printer specifications	245
Functional specifications	246
Mobile printing specifications	248
Physical specifications	248
Memory specifications	248
Power specifications	249
Environmental specifications	249
Acoustic specifications	249
Glossary	250
Index	253

1 Introduction

- [Safety precautions](#)
- [HP Start-Up Kit](#)
- [Using this guide](#)
- [Printer models](#)
- [The printer's main features](#)
- [The printer's main components](#)
- [The front panel](#)
- [Printer software](#)
- [Mobile printing](#)
- [Turn the printer on and off](#)
- [The printer's internal prints](#)

Safety precautions

Follow at all times the precautions and warnings below to use the printer safely. Do not carry out any operations or procedures other than as described in this document, because doing so may result in death, serious personal injuries, or fire.

Mains connection

- Use the power supply voltage specified on the label. Avoid overloading the printer's electrical outlet with multiple devices. Doing so can cause a fire or an electric shock hazard.
- Ensure that the printer is well grounded. Failure to ground the printer may result in electrical shock, fire, and susceptibility to electromagnetic interference.
- Use only the power cord supplied by HP with the printer. Do not damage, cut, or repair the power cord. A damaged power cord can cause fire and electric shock. Replace a damaged power cord with an HP-approved power cord.
- Insert the power cord securely and completely into the wall socket and printer inlet. A poor connection can cause a fire or an electric shock hazard.
- Never handle the power cord with wet hands. Doing so may cause electric shock hazard.
- Observe all warnings and instructions marked on the printer.

Printer operation

- Do not allow metal or liquids (except those used in HP Cleaning Kits) to touch the internal parts of the printer. Doing so may cause fire, electric shock, or other serious hazards.
- Never insert your hand into the printer while it is printing. Moving parts inside the printer may cause injuries.
- Keep the ventilation system in the room turned on when printing.
- Unplug the printer from the wall before cleaning.

Printer servicing

- There are no operator-serviceable parts inside the printer. Refer servicing to qualified service personnel. Contact your local HP Support (see [Contact HP Support on page 243](#)).
- Do not disassemble or repair the printer yourself. There are hazardous voltages inside the printer that can cause a fire or electric shock hazard.
- Internal fan blades are hazardous moving parts. Disconnect the printer before servicing.

Caution

Turn off the printer and unplug the power cord from the power outlet in any of the following cases:

- If there is smoke or an unusual smell coming from the printer
- If the printer is making an unusual noise not heard during normal operation
- If a piece of metal or a liquid (not part of cleaning and maintenance routines) touches internal parts of the printer
- During a thunderstorm

- During a power failure
- The power cord or plug is damaged
- The printer has been dropped
- The printer is not operating normally

HP Start-Up Kit

The HP Start-Up Kit is the DVD that comes with your printer; it contains the links to the printer's software and documentation.

Using this guide

This guide can be downloaded from the HP Support Center (see [HP Support Center on page 241](#)).

Introduction

This chapter provides a brief introduction to the printer and its documentation for new users.

Use and maintenance

These chapters help you carry out normal printer procedures and include the following topics.

- [Installing the software on page 15](#)
- [Setting up the printer on page 20](#)
- [Network configuration on page 35](#)
- [Personalizing the printer on page 45](#)
- [Paper handling on page 51](#)
- [Working with two rolls on page 67](#)
- [Printing on page 69](#)
- [Mobile printing on page 92](#)
- [Job queue management on page 95](#)
- [Color management on page 103](#)
- [Practical printing examples on page 115](#)
- [Retrieving printer usage information on page 132](#)
- [Handling ink cartridges and printhead on page 136](#)
- [Printer maintenance on page 149](#)

Troubleshooting

These chapters help you solve problems that may occur while printing and include the following topics.

- [Troubleshooting paper issues on page 168](#)
- [Troubleshooting print-quality issues on page 179](#)
- [Troubleshooting ink cartridge and printhead issues on page 226](#)
- [Troubleshooting general printer issues on page 230](#)
- [Front-panel error messages on page 236](#)

Accessories, support and specifications

These chapters, [Supplies and accessories on page 165](#), [HP Customer Care on page 240](#) and [Printer specifications on page 245](#), contain reference information, including customer care, the printer specifications and part numbers for paper types, ink supplies and accessories.

Glossary



The [Glossary on page 250](#) contains definitions of printing and HP terms used in this documentation.

Index

In addition to the table of contents, there is an alphabetical index to help you to find topics quickly.

Warnings and Cautions

The following symbols are used in this manual to ensure the proper use of the printer and to prevent the printer from being damaged. Follow the instructions marked with these symbols.

-
-  **WARNING!** Failure to follow the guidelines marked with this symbol could result in serious personal injury or death.
 -  **CAUTION:** Failure to follow the guidelines marked with this symbol could result in minor personal injury or damage to the printer.
-

Printer models

This guide covers the following printer models, normally referring to them by their short names for brevity.

Full name	Short name
HP DesignJet T2500 eMultifunction	T2500
HP DesignJet T2500 PostScript eMultifunction	T2500 PS
HP DesignJet T2530 Multifunction	T2530
HP DesignJet T2530 PostScript Multifunction	T2530

The printer's main features

Your printer is a color inkjet printer designed for printing high-quality images on paper up to 914 mm (36 in) wide, with an integrated color scanner capable of scanning images up to 914 mm (36 in) wide and 7 m (23 ft) long. Some major features of the printer are shown below:

- Built-in stacker for paper sizes from A4/A portrait to A0/E, with up to 50 A1/D-size capacity
- Roll and single-sheet loading from the front of the printer
- Two rolls with automatic switching, enabling long runs of unattended printing
- Six-ink system
- Integrated printhead, 9/8 in (28 mm) wide, with duplicated black nozzles improving speed and quality
- Capacitive touch-sensitive front panel in color, with an intuitive graphical user interface
- Print resolution of up to 2400 × 1200 optimized dpi, from a 1200 × 1200 dpi input
- Scan resolution of up to 600 dpi, in RGB color with 24 bits per pixel, or grayscale with 8 bits per pixel, or black and white with 1 bit per pixel
- Economode for printing economically
- Can be controlled from the built-in front panel, or from a remote computer using the Embedded Web Server or the HP Utility
- Includes Web-connected features such as automatic firmware updates, HP ePrint and Mobile Printing
- Driverless printing using AirPrint
- Paper flexibility and automatic easy load, see [Paper handling on page 51](#), with information and presets accessible from the front panel
- Accurate and consistent color reproduction with automatic color calibration
- Color emulations, see [Printer emulation on page 107](#)
- Manual printing with the stacker open, for improved handling of special jobs on photographic paper
- High-productivity features such as job previewing and nesting using the printer's Embedded Web Server
- Ink and paper usage information available from the Embedded Web Server, see [Access the Embedded Web Server on page 46](#)
- Access to online support

The printer's main components

The following front and rear views of the printer illustrate the main components.

Front view

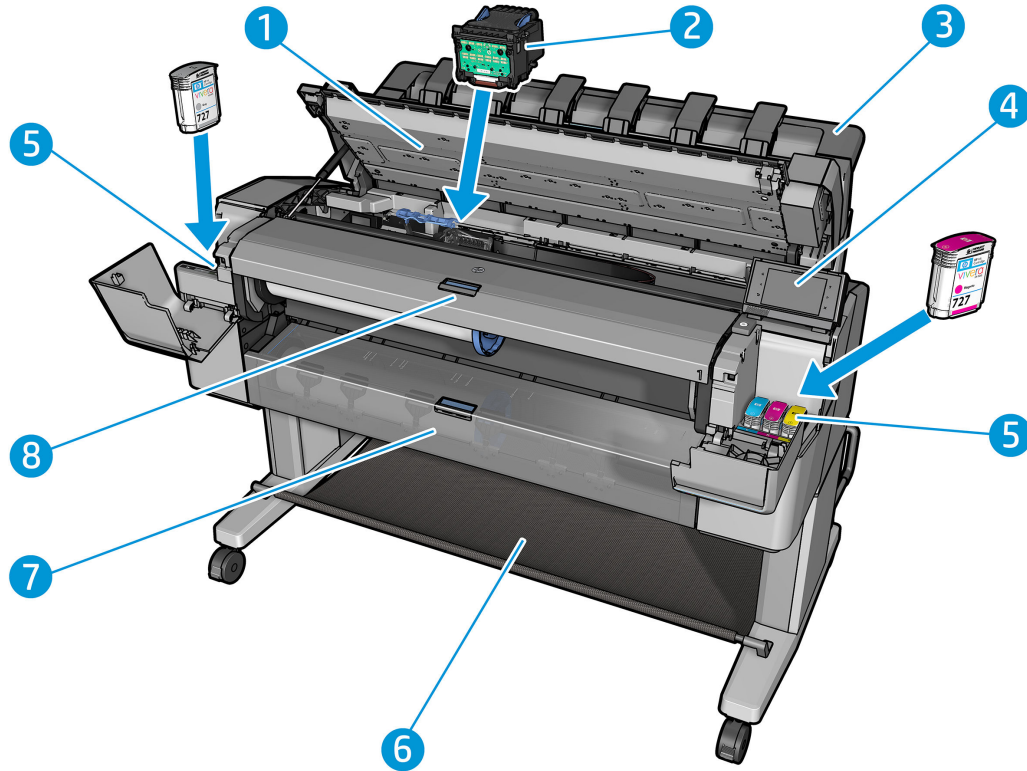

1. Scanner
2. Printhead
3. Stacker
4. Front panel
5. Ink cartridges
6. Basket
7. Lower roll cover
8. Upper roll cover

Rear view

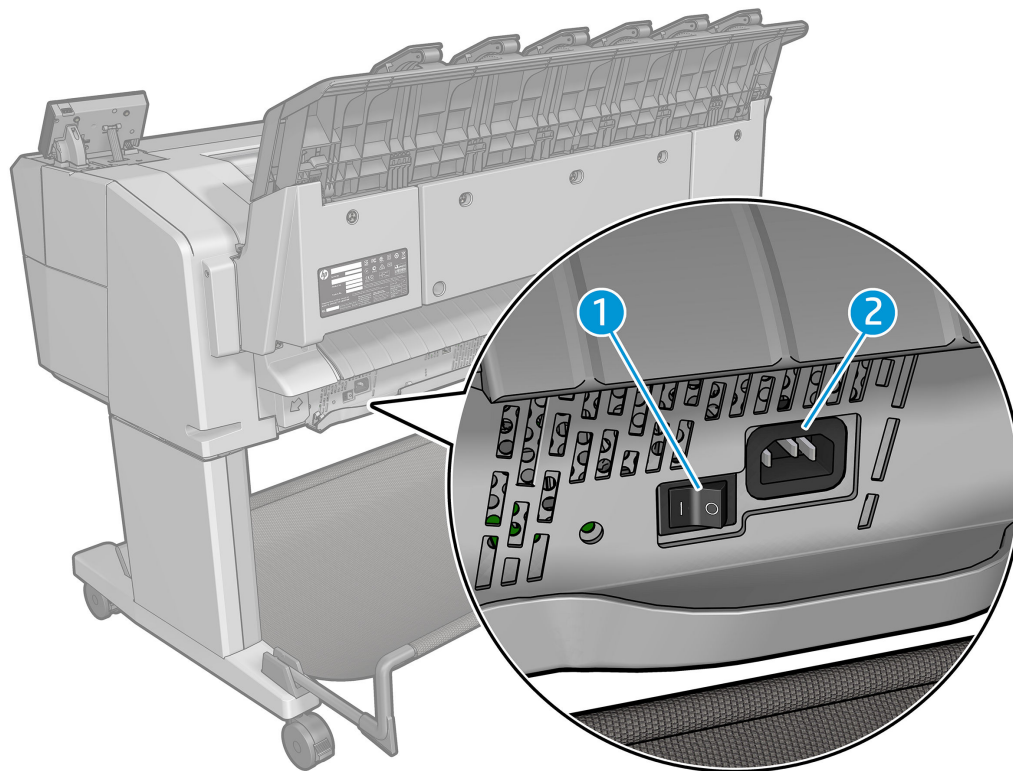

1. Power switch
2. Power socket

Communication ports

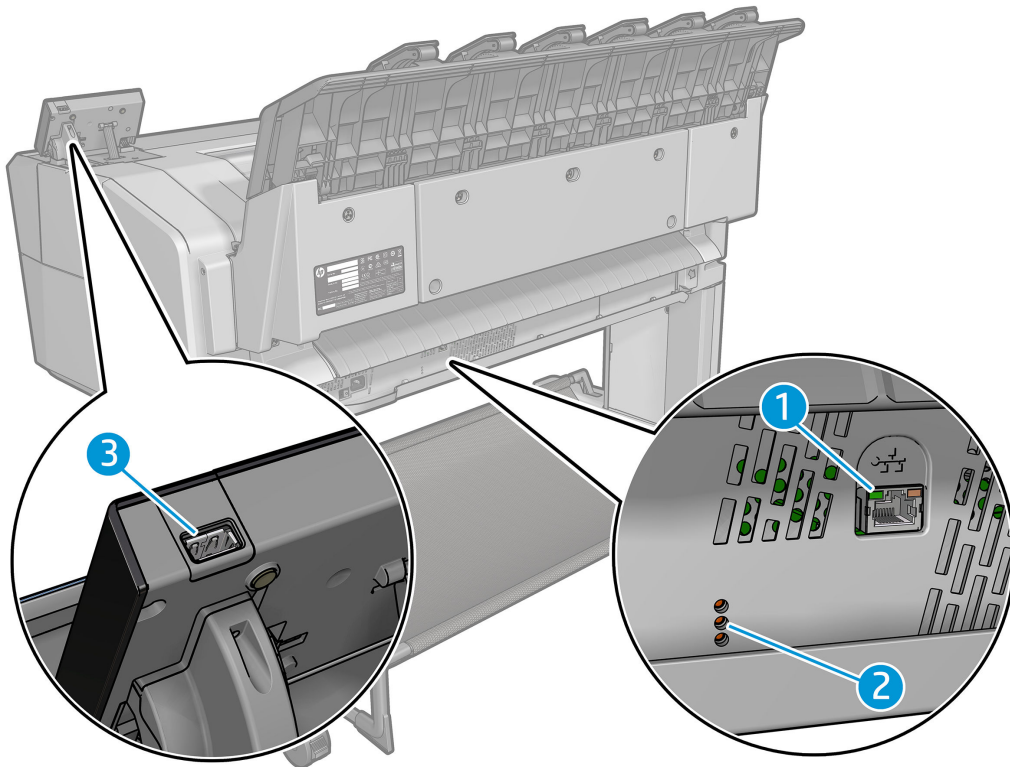



1. Gigabit Ethernet port, to connect to a network
2. Diagnostic LEDs, to be used by service engineers
3. Hi-Speed USB host port, intended for connecting a USB flash drive

The front panel

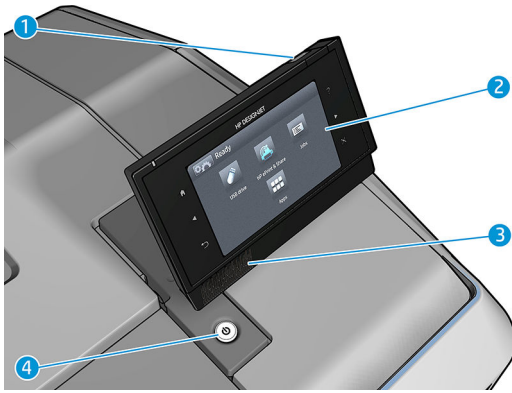

The front panel is located on the front right of the printer. It gives you complete control of your printer: from the front panel, you can print, view information about the printer, change printer settings, perform calibrations and tests, and so on. The front panel also displays alerts (warning and error messages) when necessary. Information about specific uses of the front panel can be found throughout this guide.





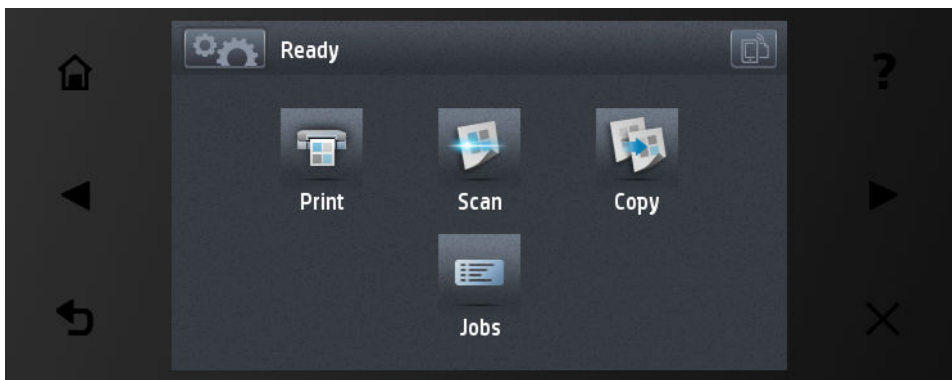



1. A Hi-Speed USB host port, intended for connecting a USB flash drive, which can provide files to be printed or a destination for scanned files. When a USB flash drive is inserted, a USB icon  is displayed on the front panel's home screen.
2. The front panel itself: a touch-sensitive screen with a graphical user interface.
3. Loudspeakers.
4. The **Power** key, with which you can turn the printer on or off. The key is illuminated when the printer is on. It flashes when the printer is in sleep mode.



The front panel has a large central area to display dynamic information and icons. On the left and right sides you can see up to six fixed icons at different times. Normally they are not all displayed at the same time.



Left and right fixed icons

- Press  to return to the home screen.
- Press  to view help about the current screen.
- Press  to go to the previous item.
- Press  to go to the next item.
- Press  to go back to the previous screen. This does not discard any changes made in the current screen.





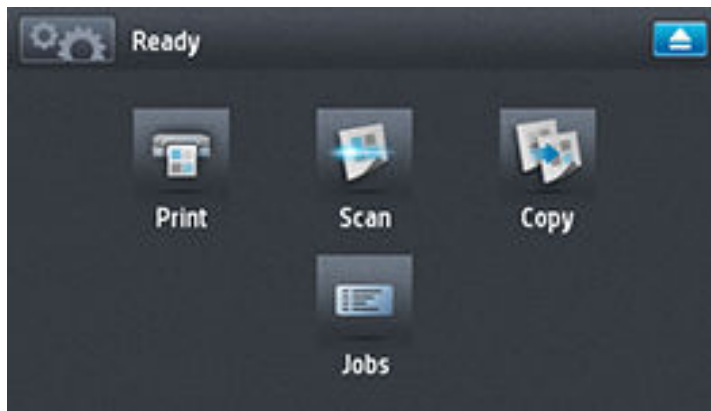

- Press  to cancel the current process.
- Press  to view the printer's email.

Home screen dynamic icons

The following items are displayed only on the home screen.

- Press  to reach the information screen, where you can view information about printer and scan status, change printer settings, or initiate actions such as loading paper or replacing ink supplies.
- Press  to release the paper from the scanner. If there is no paper in the scanner, this button is not displayed.









- To the right of the above button is a message showing the printer status or the most important current alert.
- Press  to print a file. See [Printing on page 69](#).
- Press  to scan a sheet of paper and store the image in a file, either in a network folder or in a USB flash drive. See [Scanning on page 86](#).
- Press  to copy a sheet of paper (scan and print). See [Copying on page 90](#).
- Press  to view and manage the print and scan job queues. A smaller warning icon appears if there are jobs on hold. See [Job queue management on page 95](#).
- Press  to view information about the USB flash drive. This icon appears only when a USB flash drive is inserted.
- Press  to access available applications. See <http://www.hp.com/go/designjetprinters>. This icon appears only when one or more applications are installed.

Information screen

To reach the information screen, press  on the home screen.





Information screen dynamic icons

- Press  for information about the paper status.
- Press  for information about the ink cartridge status.
- Press  for information about the printhead status.
- Press  for information about the network status.
- Press  for a list of alerts.
- Press  for information about the printer.
- Press  to view and change printer or scan settings.

Sleep mode

Sleep mode puts the printer into a reduced power state after a period of inactivity, turning off the front-panel display to save energy. Printer features can be enabled from this mode, and the printer maintains network connectivity, waking up only as necessary. The printer can be woken from sleep mode by the **Power** button, by sending a print job, or by lifting the scanner, opening a roll cover, or opening the stacker cover. The printer wakes up in several seconds, more quickly than if it is completely turned off. While in sleep mode, the **Power** button blinks.

To change the time that elapses before sleep mode, press , then , then **Setup > Front panel options > Sleep mode wait time**. You can set a time between 1 and 240 minutes; the default time is 30 minutes.

Printer Monitoring (with the Print Spooler) and Remote Printer Management with the HP Utility and Web JetAdmin continue to be available during sleep mode. Some remote management tasks offer the option of remotely waking up the printer if needed to perform the task.

Printer software

The following software is provided for your printer:

- Printer drivers
- The Embedded Web Server and (alternatively) the HP Utility allow you to:
 - Manage the printer from a remote computer (the Embedded Web Server is recommended for this purpose)
 - View the status of the ink cartridges, the printhead, and the paper
 - Update the printer's firmware, see [Update the firmware on page 151](#)
 - Perform calibrations and troubleshooting
 - Submit print jobs
 - Manage the job queue, see [Job queue management on page 95](#)
 - View job accounting information, see [Retrieving printer usage information on page 132](#)
 - Change various printer settings
 - Manage e-mail notifications
 - Change permissions and security settings
 - Set network destinations for scan
 - Scan accounting

See [Access the Embedded Web Server on page 46](#) and [Access the HP Utility on page 46](#).

 **NOTE:** The HP Utility under Mac OS X and the HP DesignJet Utility under Windows have similar functions and are sometimes referred to collectively as the HP Utility in this guide.

 **NOTE:** New versions of all printer software can be expected to appear from time to time. In some cases, when you receive your printer there may already be later versions available on HP's website of some of the software provided with it.

Mobile printing

Your printer can be connected to the Internet and Web, providing various benefits:

- Automatic firmware updates (see [Update the firmware on page 151](#))
- Print on HP Printers from almost anywhere
- Print on HP printers from almost any device, including smartphones and tablet computers.

To take advantage of these benefits, your printer must be connected to the Internet.

For the latest information, see <http://www.hpconnected.com>.

With HP Mobile Printing Solutions you can print straight from your smartphone or tablet in just a few simple steps wherever you are, by using your mobile device OS or sending an email to your printer with a PDF attachment. iOS-Apple printing is enabled through Airprint.

For Android printing, install the HP Print Service App from Google Play (if you do not have it already pre-installed in your mobile device).

For more information, see <http://www.hp.com/go/designjetmobility>.

Turn the printer on and off

If you wish to turn the printer on or off or reset the printer, the normal and recommended method is to use the **Power** key on the front panel.

However, if you plan to store the printer for a long period or the **Power** key does not seem to work, you are recommended to turn it off using the power switch at the rear.

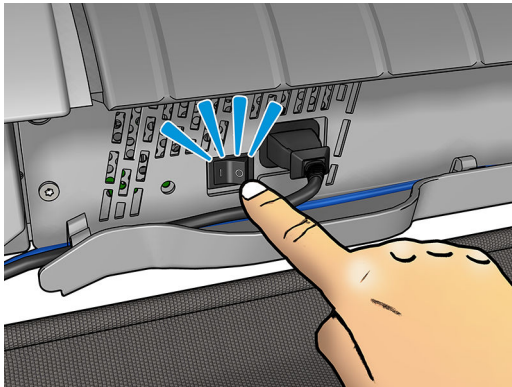

To turn it back on, use the power switch at the rear.

When the printer is powered back on, it takes about 3 minutes to initialize and check and prepare the printhead. Preparing the printhead takes about 75 seconds. However, if the printer has been off for 2 weeks or more, preparing the printhead could take up to 7 minutes, plus 13 minutes if it needs a printhead recovery.



See also [Sleep mode on page 11](#) and [Change the auto-off setting on page 47](#).

The printer's internal prints

The internal prints give various kinds of information about your printer. They can be requested from the front panel.

Before requesting any internal print, check that the printer and the paper are ready for printing.

- The loaded paper should be at least A3 landscape—420 mm (16.53in) wide—otherwise the print may be clipped.
- The front panel should be displaying the **Ready** message.

To print any internal print, press , then , then scroll down to **Internal prints** and press it, then select the internal print you want. The following internal prints are available.

- Demo prints show some of the capabilities of the printer
 - Print drawing demo
 - Print rendering demo
 - Print GIS map
- User information prints



- Usage report shows estimates of the total number of prints, number of prints by paper type, number of prints by print-quality option, counting of scans, and total amount of ink used per color (the accuracy of these estimates is not guaranteed)
- HP-GL/2 palette shows the color or grayscale definitions in the currently selected color palette
- PostScript font list shows PostScript fonts available (PostScript printers only)
- Service information prints
 - Print current information
 - Print usage information
 - Print event logs
 - Print calibration status
 - Print connectivity configuration
 - Print all pages (prints all the above reports)

2 Installing the software



- [Connect the printer to your network](#)
- [Connect a computer to the printer by network \(Windows\)](#)
- [Uninstall the printer software \(Windows\)](#)
- [Connect a computer to the printer by network \(Mac OS X\)](#)
- [Uninstall the printer software \(Mac OS X\)](#)



Connect the printer to your network



The printer is able to configure itself automatically for most networks, in a similar way to any computer in the same network. The first time you connect it to a network, this process may take a few minutes.

Once the printer has a working network configuration, you can check its network address from the front panel: press , then .

Network configuration

For more details about the current network configuration, go to the front panel and press , then , then **Connectivity > Network connectivity > Gigabit Ethernet > Modify configuration**. From here it is possible, though not normally necessary, to change the settings manually; this can also be done remotely using the Embedded Web Server.

 **TIP:** You may find it helpful to print out the full printer network configuration on paper. This can be done from the front panel: press , then , then **Internal prints > Service information prints > Print connectivity configuration**. If you do not print out the full network configuration, consider making a note of the printer's IP address and network name.

If you accidentally misconfigure the printer's network settings, you can restore the network settings to their factory values from the front panel: press , then , then **Connectivity > Network connectivity > Advanced > Restore factory settings**. Then you must restart the printer. This automatically provides a working network configuration for most networks. The printer's other settings remain unchanged.

Using IPv6

Your printer supports almost all network connectivity features using IPv6, just as it does using IPv4. To make full use of IPv6, you may need to connect your printer to an IPv6 network in which there are IPv6 routers and servers.

In most IPv6 networks, the printer will configure itself automatically as follows, and no user configuration is necessary:

1. The printer assigns itself a link-local IPv6 address (which starts with "fe80::").
2. The printer assigns itself stateless IPv6 addresses as indicated to it by any IPv6 routers on the network.
3. If no stateless IPv6 addresses can be assigned, the printer will try to obtain IPv6 addresses using DHCPv6. It will also do so if the routers instruct it to do so.

The stateless and DHCPv6 IPv6 addresses can be used to access the printer, and in most IPv6 networks this will be appropriate.

The link-local IPv6 address works only in the local subnet. Although it is possible to access the printer using this address, it is not recommended.

It is possible to assign a manual IPv6 address to the printer, using the front panel or the Embedded Web Server. It is also possible to disable IPv6 completely in the printer. However, it is not possible to disable IPv4 in the printer, and therefore it is not possible to configure the printer as IPv6-only.

 **NOTE:** In typical IPv6 use, your printer will have multiple IPv6 addresses, although it has only one IPv4 address.

 **TIP:** You are recommended to give a name to the printer. You can do this from the front panel or (more easily) from the Embedded Web Server.

TIP: You will generally find it easier to use IPv4 unless you have a specific need to use IPv6.

Microsoft Windows Vista, Microsoft Windows Server 2008, later versions of Windows, and the new HP Printing and Imaging devices have IPv6 enabled by default. For further information on IPv6, see <http://h20000.www2.hp.com/bc/docs/support/SupportManual/c00840100/c00840100.pdf>. This document discusses how name resolution plays a fundamental role in Dual-Stack transition methods. Using the name resolution algorithm in Windows, the document goes through various network environments and studies how the introduction of routable IPv6 addresses will affect network applications. It also discusses DHCPv6, SLAAC and the impact to DNS, and makes some recommendations.

Using IPsec

Your printer supports IPsec.

However, successful IPsec configuration requires advanced network expertise, and is beyond the scope of this document. For IPsec to work, the printer's IPsec configuration must exactly match that of the other devices in your network. Any discrepancy will prevent communication with your printer until the configuration is corrected or IPsec is disabled. For more information on IPsec configuration, download the file **IPsec_Admin_Guide.pdf** from <http://www.hp.com/go/T2500/manuals>.

Connect a computer to the printer by network (Windows)

The following instructions apply if you intend to print from software applications using a printer driver. See [Printing on page 69](#) for alternative ways of printing.

Before you begin, check your equipment:

- The printer should be set up and on.
- The Ethernet switch or router should be on and functioning correctly.
- The printer and the computer should be connected to the network (see [Connect the printer to your network on page 16](#)).

Now you can proceed to install the printer software and connect to your printer.

Printer software installation

1. Make a note of the printer's IP address from the front panel (see [Access the Embedded Web Server on page 46](#)).
2. Insert the *HP Start-up Kit* DVD into your computer. If the DVD does not start automatically, run the **setup.exe** program in the root folder of the DVD.
3. Navigate to the **Software Installation** button and press it.
4. Press the **Install Software** button, and choose your printer from the list of networked printers that appears, identifying it by its IP address if necessary.

If your computer fails to find any printers on the network, the **Printer Not Found** window is displayed, which helps you to try to find your printer. If you have a firewall in operation; you may have to disable it temporarily in order to find the printer. You also have the options of searching for the printer by its hostname, IP address, or MAC address.

In some cases, when the printer is not in the same sub-net as the computer, specifying the printer's IP address may be the only successful option.

5. Follow the instructions on your screen to install the printer drivers and other HP software, such as the HP DesignJet Utility.

Uninstall the printer software (Windows)

Use the Control Panel to uninstall the software, you can uninstall any software by the same method.

Connect a computer to the printer by network (Mac OS X)

You can connect your printer to a network under Mac OS X by using the following methods:

- Bonjour
- TCP/IP





TIP: Bonjour is recommended for your local network; TCP/IP is recommended for other networks.

The following instructions apply if you intend to print from software applications using a printer driver. See [Printing on page 69](#) for alternative ways of printing.

Before you begin, check your equipment:

- The printer should be set up and on.
- The Ethernet switch or router should be on and functioning correctly.
- The printer and the computer should be connected to the (wired or wireless) network. See [Connect the printer to your network on page 16](#).

Now you can proceed to install the printer software and connect to your printer.

1. Go to the front panel and press , then . Note the mDNS service name of your printer.
2. Insert the *HP Start-up Kit DVD* into your DVD drive.
3. Open the DVD icon on your desktop.
4. Your Web browser opens to display the rest of the software installation procedure. You must click on **Download OS X Installer**. Once downloaded, open the installation software to install all required components onto your system.
5. When the software has been installed, the HP Printer Setup Assistant starts automatically, to set up a connection to your printer. Follow the instructions on your screen.
6. When you reach the Select Printer screen, look for your printer's mDNS service name (which you noted in step 1) in the Printer Name column.
 - If you find the right name, scroll sideways if necessary to see the Connection Type column, and check that it shows **Bonjour**. Then highlight that line. Otherwise, continue searching further down the list.
 - If you cannot find your printer's name just click **Continue** and do setup manually in your System Preferences later on.

Click **Continue**.

7. Continue following the instructions on the screen..
8. When the HP Utility Setup Assistant has finished, you can remove the DVD from the DVD drive.

If the printer driver is already installed, the HP Printer Setup Assistant can be run at any time from the DVD.

Uninstall the printer software (Mac OS X)

During the previous Installation step, you have the option to select the HP Uninstaller. This should be available under HP in the system Applications folder.



IMPORTANT: The HP Uninstaller application will uninstall all HP Software installed in your system.

To delete the print queue only, select the **Print & Scan** dialog from the system preferences. Select the name of the printer and click the – button.

3 Setting up the printer

- [Introduction](#)
- [Set up web services](#)
- [Web Services manual configuration](#)
- [Configure a scan-to-network or scan-to-FTP folder](#)
- [Paper suitability options](#)
- [Turn nesting on and off](#)
- [Turn usage information on and off](#)
- [Turn e-mail notifications on and off](#)
- [Turn alerts on and off](#)
- [Control access to the printer](#)
- [Require account ID](#)
- [Set Windows driver preferences](#)

Introduction



This chapter describes various printer settings that the printer administrator may wish to control as soon as a new printer is assembled and ready for use.

Set up web services

Your printer can connect to the Internet to benefit from various Web Services (see also [Mobile printing on page 12](#)):

- Automatic firmware updates
- Use HP ePrint to print by email

To set up your printer for Web Services, please follow these steps, explained in more detail below:

1. Make sure that your printer is correctly connected to the Internet.
2. Run the Connectivity Wizard: At the front panel, press , then , then **Connectivity > Connectivity wizard**.



NOTE: The printer may need to restart if the firmware is updated during this process.



TIP: When the Wizard displays your printer code, you are recommended to make a note of it. A page is automatically printed with the printer's email address, instructions on how to use it and how to manage printer security.

3. This is an optional step: If you are the printer administrator, log in at the HP ePrint Center (<http://www.hp.com/go/eprintcenter>) to customize your printer's email address or manage printer security for remote printing.

Congratulations, you now have completed Web Services setup. HP ePrint is ready to use.

For the latest information, support, and terms of use of HP Connected, visit its website: <http://www.hpconnected.com> (Check your region's availability).

Web Services manual configuration

The Connectivity Wizard (see [Set up web services on page 21](#)) is normally sufficient for Web Services configuration, but there are also facilities for manual configuration if you wish to use them.

Configure the printer's Internet connection

You can configure the printer's Internet connection from the Embedded Web Server or from the front panel.



NOTE: If an administrator password has been set, it will be required to change these settings. Thus, the administrator can prevent the printer from being connected to the Internet, if desired.

- **In the Embedded Web Server:** select **Setup > Internet connection**.
- **Using the front panel:** press , then , then **Connectivity > Internet connectivity**.

The following settings are available:

- **Internet connection:** The default value is **Yes**.
- **Proxy > Enable proxy:** Enable or disable a proxy server.
- **Proxy > Proxy address:** Enter the proxy address, empty by default.
- **Proxy > Proxy port:** Enter the proxy port number, zero by default.
- **Proxy > Proxy authentication:** Enable or disable authentication.
- **Proxy > Restore factory settings:** Return to the initial default settings.

If you have trouble with your Internet connection, see [Cannot connect to the Internet on page 233](#).

Configure firmware updates

You can choose from the Embedded Web Server or from the front panel whether and how to download firmware updates.



NOTE: If an administrator password has been set, it will be required to change these settings.

- **In the Embedded Web Server:** select **Setup > Firmware update**.
- **Using the front panel:** press , then , then **Updates > Firmware update**.

The following settings are available:

- **Check:** If you select **Automatically** (the default setting), the printer will check automatically every week (or after the printer has been restarted seven times, whichever happens first) whether new firmware is available. If you select **Manually**, the printer will not check automatically; you can check manually whenever you like.
- **Download:** If you select **Automatically** (the default setting), the printer will automatically download new firmware whenever it becomes available. If you select **Manually**, you will be asked to approve each download.



NOTE: Downloading the firmware does not mean that you have installed it in your printer. To install the new firmware, you must confirm the installation manually.

- **Firmware update information:** Information about the firmware currently installed
- **Firmware update history:** A list of firmware versions that have been installed in the printer. It is usually possible to reinstall the version immediately before the version that is currently installed, if you have some problem with the current version.

Set remote printing preferences

At the front panel, press , then , then **Setup > Printing preferences** to define the default properties of jobs sent to your printer from remote locations.

- **Printer margins:** Choose between **Clip from contents** and **Add to content**.
- **Color:** Choose between **Color**, **Grayscale**, and **Black and white** printing.
- **Print quality:** Choose between **Best**, **Normal**, and **Fast**.

- **Roll:** Choose between **Roll 1**, **Roll 2**, and **Save paper**, which automatically chooses the narrowest roll on which the print will fit.
- **HP ePrint Center jobs:** Choose between **On hold** and **Direct print**. By default, jobs from the cloud are **On hold**. If you choose **Direct print**, the front panel will not ask for permission before printing.

Configure a scan-to-network or scan-to-FTP folder

A scanned image may be saved in a USB flash drive, in a network folder, or in an FTP folder. The USB flash drive option requires no preparation, but the other options will not work until they have been set up in the following way.

 **NOTE:** The printer accesses shared folders (as a client) using NTLMv1-based authentication. If, for security reasons, you prefer not to expose user credentials using NTLMv1, you should avoid using a scan-to-network or scan-to-FTP folder.

Scan to network folder

1. Create a folder on a computer that the scanner can access through the network. See [Example: Create a scan-to-network folder under Windows on page 25](#) or [Example: Create a scan-to-network folder under Mac OS on page 27](#).
2. Create a user account on the same computer for the printer.
3. Change the sharing options of the folder so that it is shared with the 'scanner user', and assign full control of the folder to that user.
4. Create a share name for the folder.

Scan to FTP folder

1. Create a folder on an FTP server.
2. Ensure that you know the server name, user name, and password for the FTP server.

 **IMPORTANT:** You must complete the above steps for one option or the other before starting the remaining steps below.

1. In the printer's Embedded Web Server, select the **Setup** tab and then **Scan to network**. See [Access the Embedded Web Server on page 46](#).

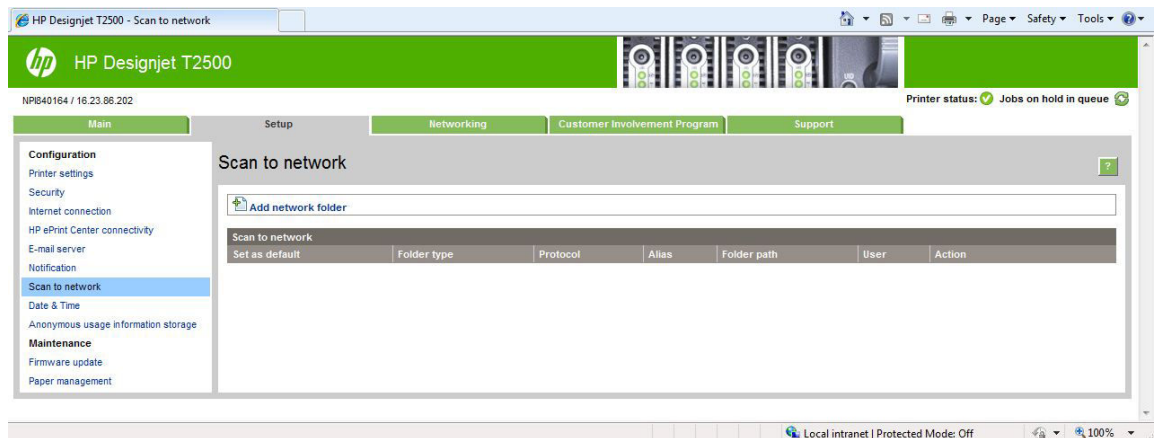

Alternatively, in the HP Utility, select the **Settings** tab and then **Scan to network**. See [Access the HP Utility on page 46](#).

2. On the Scan to Network page, click **Add folder details**, and fill in the various fields.

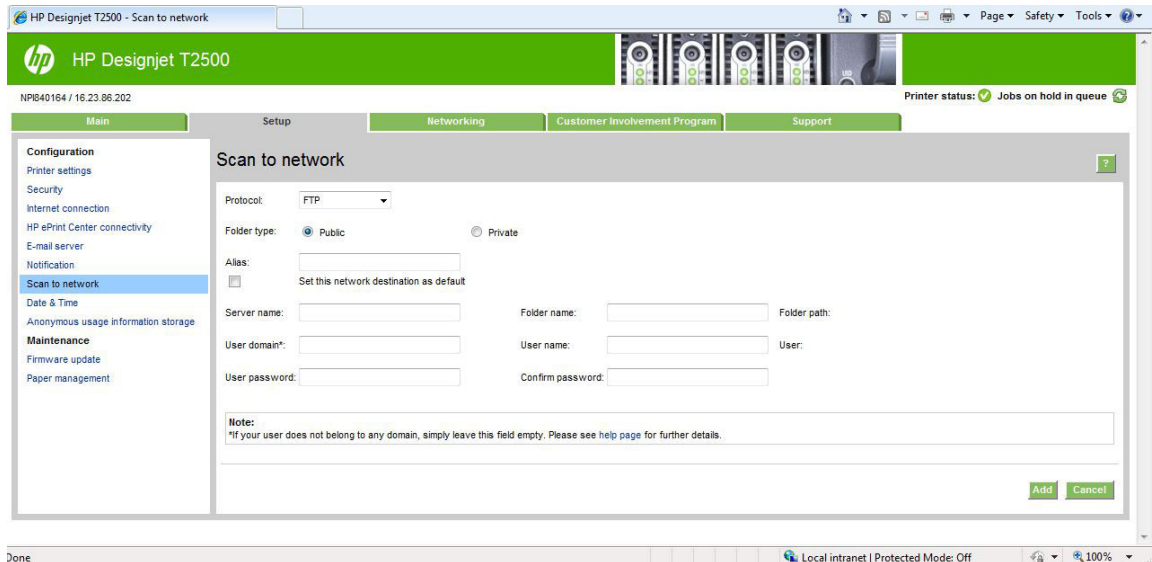

- **Protocol** may be FTP or CIFS (Windows).
- **Folder type** may be public or private. The folder type is displayed in both the Embedded Web Server and the front panel with an icon. When you select a private folder, you must enter a password in the front panel.
- **Alias name** is displayed in the front panel when you are choosing the scan destination. It may be different from the network or FTP folder name.
- **Server name** should contain the network name of the remote computer.
- **Folder name** should contain the share name of the folder.
- **User name** should contain the name of the 'scanner user'.
- **User password** should contain the password of the 'scanner user'.
- **Domain name** should contain the name of the domain in which the user name exists. If the 'scanner user' does not belong to any domain, leave this field empty.

The server and folder names are used to connect to the shared folder by building a network folder path as follows: `\\server name\folder name`

For a **network folder**, enter the name or IP address of the remote computer, the name of the shared folder, and the user name and password of the 'scanner user' that you have already created on the remote computer. Leave the user domain field empty unless the user is a member of a Windows domain. If the user is only a local user of the remote computer, leave the field empty. You can use the name (instead of the IP address) in the server name field only if the shared folder is on a Windows computer in the same local network. This must be a simple name (up to 16 characters long) without a domain suffix (without any dots in the name). Fully qualified DNS domain names are not supported. If the product and the network folder are in different networks, or if the remote computer is not running Windows, then you must use the IPv4 address instead of the name of the remote computer. On IPv6 networks the IPv6 address is also supported.

For an **FTP folder**, enter the server name, folder name, user name, and password. Leave the user domain empty.

3. Click **Add** to save the configuration.

 **NOTE:** If the product has already been configured for scanning to the network and you now want to use a different shared folder, click **Modify**.

4. The printer automatically checks that it can access the network folder. If not, see [Cannot access the network folder on page 198](#).

You can check at any later time that the shared folder remains accessible by clicking **Verify** in the Embedded Web Server. A correctly configured shared folder can become inaccessible if the user's password is changed, or if the shared folder is moved or deleted.

Example: Create a scan-to-network folder under Windows

1. Create a new user account for the 'scanner user' on the remote computer. You can use an existing user account for this purpose, but it is not recommended.
2. Create a new folder on the remote computer, unless you want to use an existing folder.
3. Right-click the folder and select **Properties**.
4. In the **Sharing** tab, click the **Advanced Sharing** button.

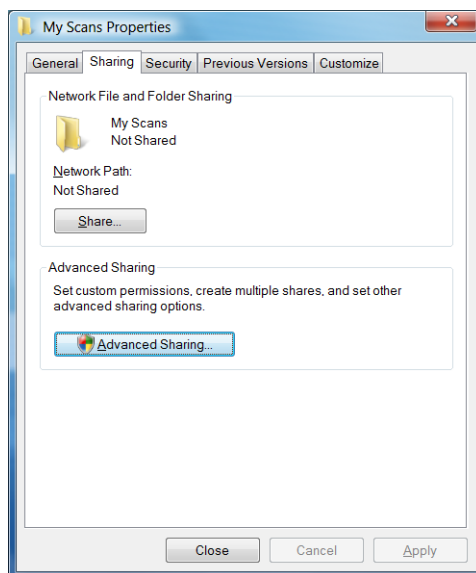

5. Check the **Share this folder** box.

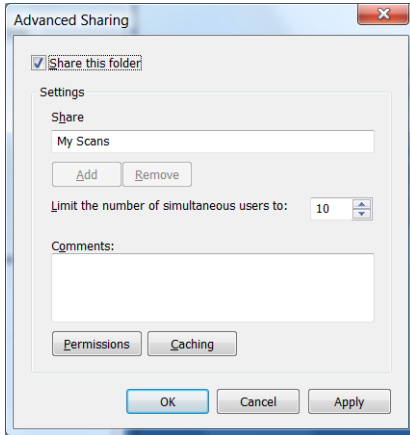

6. You need to ensure that the 'scanner user' has full read/write control over the shared folder. To do this, click **Permissions** and grant **Full Control** to the user (or to any suitable group that includes that user).

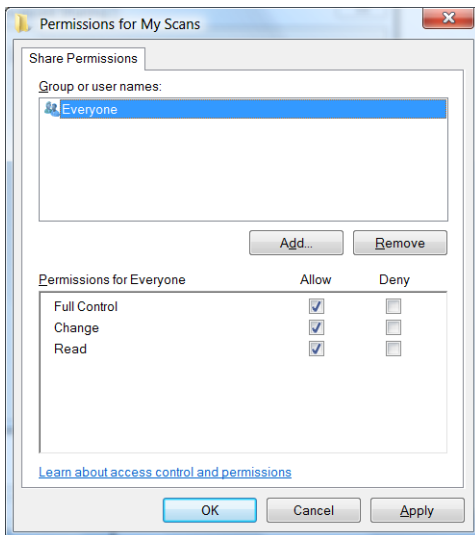

- If there is a **Security** tab in the Properties window for your folder, then you must also grant the same user **Full Control** over the folder in the **Security** tab. Only some file systems such as NTFS require this.

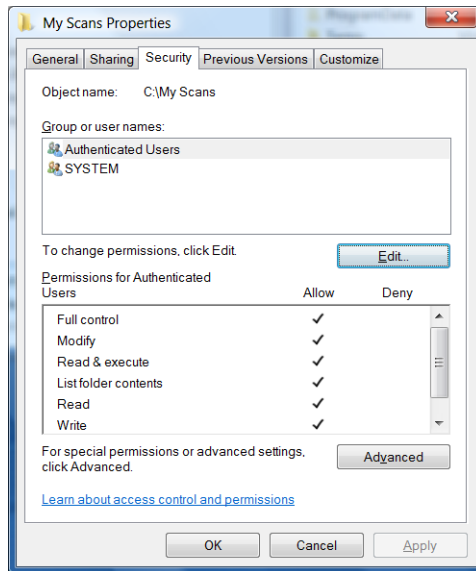

The 'scanner user' can now access the folder and write files to it. Next, you must configure the printer to send scans to the folder.

Example: Create a scan-to-network folder under Mac OS

- Create a new user account for the 'scanner user' on the remote computer. You can use an existing user account for this purpose, but it is not recommended.
- Create or choose a folder on the remote computer. By default, Mac OS users have a **Public** folder that can easily be used for this purpose.
- Open the **System Preferences** application and select the **Sharing** icon.

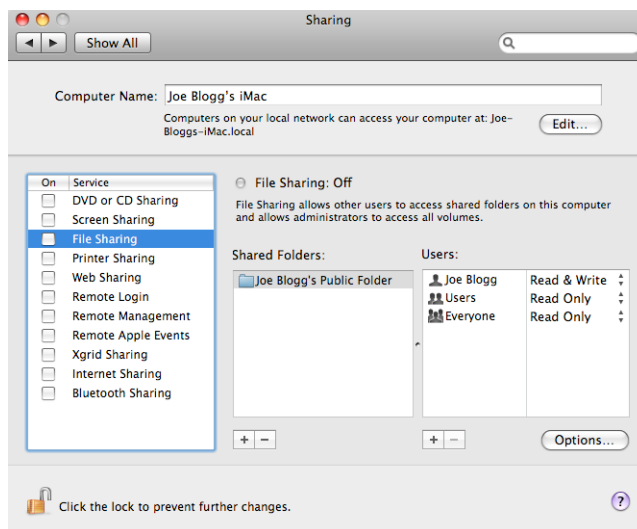

- Make sure the 'scanner user' has **Read & Write** access to the folder.
- Click **Options**.

6. Check the **Share files and folder using SMB** box, and make sure that the 'scanner user' is checked in the On column.

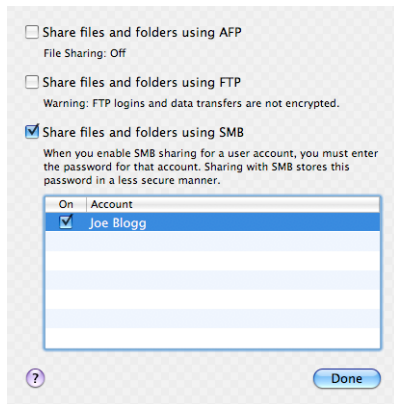

7. Click **Done**. You will now see file sharing enabled and Windows sharing on.

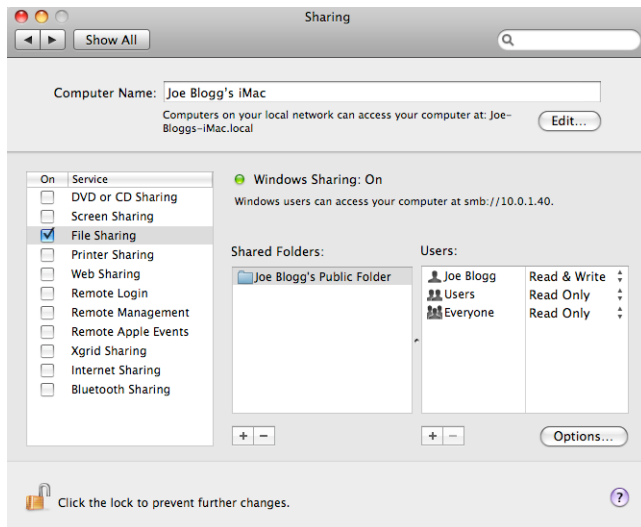

The 'scanner user' can now access the folder and write files to it. Next, you must configure the printer to send scans to the folder.





Paper suitability options

Paper mismatch action

If the paper currently loaded in the printer is not suitable for a particular job, the printer can either put the job on hold until some suitable paper is loaded, or it can ignore the problem and print the job on the unsuitable paper. There are several ways in which the loaded paper may be considered unsuitable:



- The paper type is not as specified for the job
- The paper source (roll 1, roll 2 or sheet) is not as specified for the job
- The paper size is smaller than specified for the job

You can set the printer's behavior in such cases from the front panel.

- Press , then , then **Setup > Job management > Paper mismatch action > Print anyway** if you want such jobs to print on whatever paper is loaded. This is the default option when printing from a software application or from the Embedded Web Server; but it does not work when printing from a USB flash drive.
- Press , then , then **Setup > Job management > Paper mismatch action > Put job on hold** if you want such jobs to be put on hold. The printer will send an alert whenever a job is put on hold.

When a job is put on hold for paper, it is kept in the printer queue until some suitable paper is loaded, after which you can visit the queue and choose to resume printing it. Meanwhile, other jobs with different requirements can continue printing.

Roll switching options

If two rolls are loaded, both of which are suitable for the job, the roll will be chosen according to your preferences. These can be set from the front panel: press , then , then **Setup > Printing preferences > Paper options > Roll switching options**.

- **Minimize paper waste.** If this option is chosen, the printer will choose the narrowest roll that meets all the criteria, to avoid wasting paper due to trimming. This is the default option.
- **Minimize roll changes.** If this option is chosen, the printer will choose the roll that is currently active, to avoid wasting time with a roll switch.
- **Use roll with less paper.** If this option is chosen, the printer will choose the roll that has the least paper.





NOTE: This option is effective only if you have enabled **Printing paper info** (see [Printing paper info on page 64](#)). Otherwise, it has the same effect as **Minimize paper waste**.

Turn nesting on and off

Nesting means automatically printing images or document pages side by side on the paper when feasible, rather than one after the other. This is done to avoid wasting paper. See [Nest jobs to save roll paper on page 81](#).

To turn nesting on or off, you must first make sure that the job queue is enabled (see [Turn off the job queue on page 98](#) or [Turn off the job queue on page 102](#)) and the start of printing is set to **After Processing** (see [Select when to print a job in the queue on page 96](#) or [Select when to print a job in the queue on page 100](#)). Then:

- **In the HP DesignJet Utility for Windows:** from the **Admin** tab, select **Printer settings > Job Management > Nest**.
- **In the HP Utility for Mac OS X:** select **Configuration > Printer Settings > Configure Printer Settings > Job Management > Nest**.
- **In the Embedded Web Server:** select **Setup > Printer settings > Job management > Nest**.
- **Using the front panel:** press , then , then **Setup > Job management > Nest options > Nesting**.

In each case, you will see the following options:

- **In order:** pages are nested in the order in which they are sent to the printer. The nested pages are printed as soon as one of three conditions is met:

- The next page will not fit on the same row as the other pages already nested.
- No page has been sent to the printer during the specified wait time.
- The next page is incompatible with the pages already nested (see [Nest jobs to save roll paper on page 81](#)).
- **Optimized order:** pages are not necessarily nested in the order in which they are sent to the printer. When it receives an incompatible page, the printer holds it and waits for compatible pages to complete the nest. The nested pages are printed as soon as one of three conditions is met:
 - The next page will not fit on the same row as the other pages already nested.
 - No page has been sent to the printer during the specified wait time.
 - The incompatible-page queue is full. The printer can queue up to six incompatible pages while nesting compatible pages. If it receives a seventh incompatible page, the nest is printed as it is.
- **Off:** nesting is disabled. This is the default option.

The nesting wait time can be set at the front panel: press , then , then **Setup > Job management > Nest options > Wait time**.

 **TIP:** **Optimized order** uses the minimum amount of paper; however, it may take longer to print because the printer waits for compatible pages to arrive.

Turn usage information on and off

The printer can send usage information periodically by e-mail. You can request this in the following ways:

- **In the HP DesignJet Utility for Windows:** from the **Admin** tab, select **Printer settings > Accounting**.
- **In the HP Utility for Mac OS X:** select **Configuration > Printer Settings > Configure Printer Settings > Accounting**.
- **In the Embedded Web Server:** select **Setup > Printer settings > Accounting**.

In each case, you must set the following options:

- **Send accounting files: On** (the default is **Off**)
- **Send accounting files to:** a valid e-mail address
- **Send accounting files every:** choose a number of days (1–60) or a number of prints (1–500)

You must also ensure that the e-mail server has been configured. To configure the e-mail server using the Embedded Web Server, select **Setup > E-mail server**, and fill in the following fields:

- **SMTP server:** the IP address of the outgoing mail server (SMTP) that will process all e-mail messages from the printer. If the mail server requires authentication, e-mail notifications will not work.
 - **Printer e-mail address:** each e-mail message sent by the printer must include a return address, which does not need to be a real, functional e-mail address, but it should be unique, so that recipients of the message can identify the printer that sent it. This is not the same e-mail address that is used by HP ePrint.
 - **Name**

- **Port number**
- **Authentication.** If you choose authentication, you are also asked for your username and password.

Turn e-mail notifications on and off

In order to receive e-mail notifications from the printer, you must have configured the e-mail server (see [Turn usage information on and off on page 30](#)).

The notification service is always turned on, but all specific notifications are turned off by default. You can turn them on or off individually by selecting **Notifications** from the **Setup** tab of the Embedded Web Server.

Turn alerts on and off

Printer alerts warn you when there is a printer problem that you can correct by taking action, or when one of your printing jobs changes its status. The alerts are displayed by the printer's front panel, by the HP Utility, and by the Embedded Web Server.

You can change the alert settings in various ways to display all, some, or none of the available alerts.

To access alert settings under Windows

- Select **Alert Settings** in the **Tools** menu of the HP DesignJet Utility.
 - Select **Alert Settings** in any alert page displayed by the HP DesignJet Utility.
 - Right-click the system tray icon of the HP DesignJet Utility, and select **Alert Settings**.
- In the Alert Settings window, you can use the Alerting slider to turn off alerts completely.

Alternatively, you can choose when, if ever, to display critical or non-critical alerts.

To access alert settings under Mac OS X

- Open HP Printer Monitor preferences, select your printer, and then **Customize Alerts**, so that you can set each individual alert to appear in specific cases and with a specific time interval.

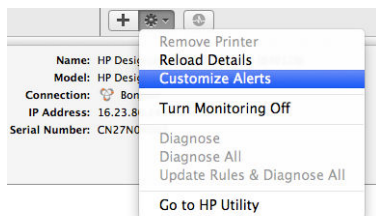

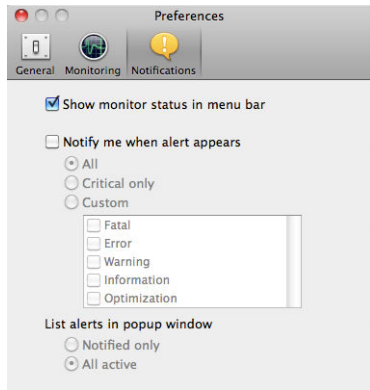

You can turn off alerts completely by unchecking the “Show monitor status in menu bar” box in the Notifications tab of the HP Printer Monitor preferences. If you leave that box checked but uncheck the “Notify me when alert appears” box (as below), the alerts will be available in the HP Printer Monitor, but will not pop up in the Dock screen.



Control access to the printer

Front-panel security settings

From the front panel, you can press , then , then **Security**, to control some of the features of the printer.

- **USB drive:** Enable or disable the use of a USB flash drive.
- **Firmware update from USB:** Enable or disable firmware updates from a USB flash drive.
- **Internet connection:** Enable or disable the Internet connection.

 **NOTE:** If you disable it, you also disable automatic firmware updates and remote printing.

- **Enable HP Connected:** Enable or disable the use of HP DesignJet ePrint with a computer connected directly to the printer.
- **User sessions:** Enable or disable automatic log-out after 1, 3, or 5 minutes.
- **Printer access control:** Enable, disable, or change the administrator password.

If an administrator password has been set, it must be given in order to perform the following operations:

- Change the security settings (including the administrator password itself)
- Change the configuration of the Internet connection
- Change the Automatic Firmware Update configuration
- Enable or disable automatic downloading and/or installation of automatic firmware updates
- Restore an earlier firmware version
- Reset factory defaults

 **NOTE:** The administrator password can contain only characters that appear on the front panel's on-screen keyboard. If you set a new password with the Embedded Web Server, it will reject characters that do not appear in that limited character set.

Embedded Web Server security settings



From the Embedded Web Server, you can select the **Security** tab to control access to the printer in various ways:

- Specify separate administrator and guest passwords to control access to the Embedded Web Server
- Securely erase some or all files on the hard disk
- Enable or disable various groups of front panel operations
- Use the same security settings that are available in the front panel (see above)

 **NOTE:** An administrator password may be required.

 **NOTE:** For more information, see the Embedded Web Server's online help.

Disable HP Connected

You can disable the connection to HP Connected if required for security. At the front panel, press , then , then **Connectivity > HP ePrint Center connectivity > HP ePrint Center connectivity** and select **Disable**.

Disable just puts the remote printing function on hold. If you want to resume using it, you just need to re-enable it in the same menu. No more setup steps are required at the HP Connected website.

If you want to disable remote printing permanently, select **Disable permanently**, which erases your printer from your HP Connected account. To use remote printing again, you will need to set it up again from scratch (see [Set up web services on page 21](#)).

 **NOTE:** You can prevent non-administrators from changing these options by setting an administrator password in the Embedded Web Server (**Setup > Security**).

Require account ID

If you want to keep records of printer usage by different user accounts, you can set your printer to require an account ID for each job.

- **In the HP DesignJet Utility for Windows:** from the **Admin** tab, select **Printer settings > Accounting > Require account ID**.
- **In the HP Utility for Mac OS X:** select **Configuration > Printer Settings > Configure Printer Settings > Accounting > Require account ID**.

If this setting is turned on, the account ID field will be mandatory and jobs with no account ID will be kept "on hold for accounting".

The account ID can be set in the printer driver when sending the job. If the job is set "on hold for accounting" by the printer, you can introduce the account ID in the Embedded Web Server, HP DesignJet Utility, or HP Utility by going to the job queue and clicking the job that is on hold. A window with a text box is displayed and you can enter the account ID into it.

Set Windows driver preferences

You can change some default settings in your printer driver according to your own preferences, for instance to set color emulation or paper-saving options. To do this, press the **Start** button on your computer's screen, then select **Devices and Settings**. In the Devices and Settings window, right-click your printer's icon, and select **Printing Preferences**. Any settings you change in the Printing Preferences window will be saved as default values for the current user.

To set the default values for all users of your system, right-click the printer's icon, select **Printer Properties**, go to the **Advanced** tab, and select **Printing Defaults**. Any settings you change in the printing defaults will be saved for all users.

Other settings, such as **Delivery Option constraint** (referring to the stacker's manual and normal modes), can be changed in the printer properties. To do this, press the **Start** button, select **Devices and Settings**, right-click your printer's icon, and select **Printer Properties**. Select the **Device Settings** tab to define the new default values.

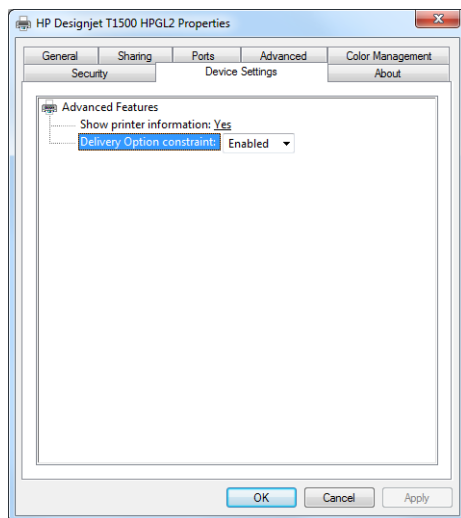

4 Network configuration

- [Introduction](#)
- [Verify correct operation](#)
- [Preconfigure network settings if required](#)
- [Add the printer to your network system](#)
- [Troubleshooting](#)
- [Reset network parameters](#)
- [Control network protocols](#)
- [Front-panel menu items](#)
- [Embedded services](#)
- [Supported network protocols](#)

Introduction

The printer provides a single RJ-45 connector port for a network connection. In order to meet Class B limits, the use of shielded I/O cables is required.

The embedded Jetdirect print server supports connection to IEEE 802.3 10Base-T Ethernet, IEEE 802.3u 100Base-TX Fast Ethernet and 802.3ab 1000Base-T Gigabit Ethernet compliant networks. When connected and powered on, the printer auto-negotiates with your network to operate with a link speed of 10, 100, or 1000 Mbps, and to communicate using full- or half-duplex mode. However, you can manually configure the link using the printer's front panel, or through other configuration tools once network communication is established.

The printer can support multiple network protocols simultaneously, including TCP/IPv4 and TCP/IPv6. For security, it includes features to control IP traffic to and from the printer and supports configuration of IP Security (IPsec) protocols.

Verify correct operation

1. Print an IO Configuration page to check for status messages.
2. In the upper section of the IO Configuration page, look for the status message **I/O Card Ready**.
3. If **I/O Card Ready** appears, the print server is operating properly. Proceed to the next section.

If a message other than **I/O Card Ready** appears, try the following:

- a. Turn the printer off and then on again to re-initialize the print server.
- b. Check that the status indicator lights (LEDs) are providing proper status.



NOTE: See [Troubleshooting on page 37](#) for link configuration and troubleshooting information.

See the *HP Jetdirect Print Servers Administrator's Guide* for your print server model to interpret and troubleshoot other messages.

Preconfigure network settings if required

If your network requires that you configure network settings before you add the printer to your network systems, you can do so now.

However, in most cases, you can skip this section. Instead, you can proceed directly to the next section to install the printer on your network computer systems. The network installation software will allow you to configure basic network settings and add the printer to your system configuration.

Tools for preconfiguration

The following tools can be used to preconfigure your network settings.

- The front panel
- The Embedded Web Server
- You can use an advanced configuration method, such as BootP, DHCP, Telnet, or the arp and ping commands. For instructions, see the *HP Jetdirect Print Servers Administrator's Guide* for your print server model.

After the printer is configured with network settings, the configuration values are saved and maintained even after it is turned off and on again.

Add the printer to your network system

When the printer is configured for proper operation on your network, you can then add the printer on each computer that will send print jobs directly to it. To add the printer to your system configuration, you must use network printer installation software for your system. You are recommended to use the HP Start-Up Kit DVD that came with your printer.

Client-server printing

After you have set up the printer, you will need to set up your network clients to access it. The procedures depend on the available utilities for your particular clients and network operating system.

For more information, refer to the documentation and help supplied with your operating system.

UNIX or Linux systems

The printer supports operation with UNIX or Linux systems over a network. Use your system utilities to install the printer. For more help, visit http://www.hp.com/support/net_printing.

Troubleshooting

IO Configuration page

The IO Configuration page provides comprehensive print server status. It is an important diagnostic tool, especially if network communications are not available. For a description of messages that may appear on the IO Configuration page, see the *HP Jetdirect Print Servers Administrator's Guide* for your print server model.

LEDs

The printer has status lights (LEDs) that indicate the link status and network activity.

- When the green light is on, the printer has successfully linked to the network.
- When the yellow light is blinking, there is network transmission activity.

Link troubleshooting

If the printer does not successfully connect to the network:

- Both LEDs will be off.
- **LAN Error - Loss of Carrier** will be indicated on the IO Configuration page.

If a link failure is indicated, try the following:

- Check cable connections.
- Manually configure the link setting to match the port configuration of the network hub or switch. For manual configuration methods, see [Link configuration methods on page 38](#). Turn the printer off, then on again, to re-initialize the setting.

- Print an IO Configuration page and check link settings.

Item	Description
Port Config	<p>If the printer is properly linked, this item has one of the following values:</p> <ul style="list-style-type: none"> • 10BASE-T HALF: 10 Mbps, half-duplex • 10BASE-T FULL: 10 Mbps, full-duplex • 100TX-HALF: 100 Mbps, half-duplex • 100TX-FULL: 100 Mbps, full-duplex • 1000TX FULL <p>If the printer is not properly linked, one of the following messages will appear:</p> <ul style="list-style-type: none"> • UNKNOWN: The printer is in an initialization state. • DISCONNECTED: A network connection has not been detected. Check network cables. Reconfigure the link settings, or restart the printer.
Auto Negotiation	<p>Indicates whether auto-negotiation for link configuration is on or off.</p> <ul style="list-style-type: none"> • ON (default): The printer will attempt to automatically configure itself onto the network at the proper speed and communication mode. • OFF: You must manually configure the link speed and communication mode using the front panel. Your settings must match those of the network for proper operation.

Link configuration methods

The printer supports 10, 100, or 1000 Mbps network link speeds using full-duplex or half-duplex communication modes (a 1000T half-duplex selection is not supported). By default, it will attempt to auto-negotiate its link operation with the network.

When connecting to network hubs and switches that do not support auto-negotiation, the printer will configure itself for 10 Mbps or 100 Mbps half-duplex operation. For example, when connected to a non-negotiating 10 Mbps hub, the print server will automatically set itself to operate at 10 Mbps half-duplex.

If the printer is not able to connect to the network through auto-negotiation, you can set the link setting by one of the following methods:

- The front panel
- The Embedded Web Server
- The Telnet interface, through a system command prompt
- A TFTP (Trivial File Transfer Protocol) configuration file that is downloaded, for example, from a BootP or DHCP server
- network management tools such as HP Web Jetadmin

Reset network parameters

Network parameters (for example, the IP address) can be reset to factory default values by a cold reset: turning the printer off and on again. After a cold reset, print an IO Configuration page to confirm that factory-reset values have been assigned.

⚠ CAUTION: A factory-installed HP Jetdirect X.509 certificate will be saved over a cold reset to factory default values. However, a Certificate Authority (CA) certificate that has been installed by the user to validate a network authentication server will not be saved.

See also [The printer behaves strangely on page 232](#).

Control network protocols

The printer can simultaneously support multiple network communication protocols. This allows network computers that may be using different protocols to communicate with the same printer.

Each protocol may require some configuration before the printer can communicate on the network. For some protocols, required parameters are automatically sensed and user-specified settings are not needed. However, for other protocols, there may be many parameters to configure.

Enable or disable network protocols

If a network protocol is enabled, the printer may actively transmit on the network even when there are no computers on the network that use the protocol. This may increase network traffic. To eliminate unnecessary traffic, you can disable unused protocols. Disabling unused protocols lets you:

- Reduce network traffic by eliminating broadcast messages from unused protocols
- Provide better control over who prints to the printer by eliminating users from other networks who might route print jobs to this printer
- Display protocol-specific error conditions for enabled protocols only

To disable unused protocols through the device's control panel menu, see [Front-panel menu items on page 39](#). For other tools, such as system command access to the embedded Telnet server, see the *HP Jetdirect Print Server Administrator's Guide* for your print server model.

Front-panel menu items

Menu item	Sub-menu item	Sub-menu item	Values and Description
TCP/IP	Host Name		An alphanumeric string, up to 32 characters, used to identify the device. This name is listed on the HP Jetdirect configuration page. The default host name is NPIxxxxxx, where xxxxxx is the last six digits of the LAN hardware (MAC) address.

Menu item	Sub-menu item	Sub-menu item	Values and Description
	IPv4 Settings	Config Method	<p>Specifies the method that TCP/IPv4 parameters will be configured on the HP Jetdirect print server.</p> <p>Bootp: Use BootP (Bootstrap Protocol) for automatic configuration from a BootP server.</p> <p>DHCP (default): Use DHCP (Dynamic Host Configuration Protocol) for automatic configuration from a DHCPv4 server. If selected and a DHCP lease exists, DHCP Release and DHCP Renew menus are available to set DHCP lease options.</p> <p>Auto IP: Use automatic link-local IPv4 addressing. An address in the form 169.254.x.x is assigned automatically.</p> <p>Manual: Use the Manual Settings menu to configure TCP/IPv4 parameters.</p>
		DHCP Release	<p>This menu appears if Config Method was set to DHCP and a DHCP lease for the print server exists.</p> <p>No (default): The current DHCP lease is saved.</p> <p>Yes: The current DHCP lease and the leased IP address are released.</p>
		DHCP Renew	<p>This menu appears if Config Method was set to DHCP and a DHCP lease for the print server exists.</p> <p>No (default): The print server does not request to renew the DHCP lease.</p> <p>Yes: The print server requests to renew the current DHCP lease.</p>
		Manual Settings	<p>(Available only if Config Method is set to Manual) Configure parameters directly from the printer control panel:</p> <p>IP Address: The unique IP address of the printer (n.n.n.n).</p> <p>Subnet Mask: The subnet mask for the printer (n.n.n.n).</p> <p>Syslog Server: The IP address of the syslog server (n.n.n.n) used to receive and log syslog messages.</p> <p>Default Gateway: The IP address (n.n.n.n) of the gateway or router used for communications with other networks.</p> <p>Idle Timeout: The time period, in seconds, after which an idle TCP print data connection is closed (default is 270 seconds, 0 disables the timeout).</p>
		Default IP	<p>Specify the IP address to default to when the print server is unable to obtain an IP address from the network during a forced TCP/IP reconfiguration (for example, when manually configured to use BootP or DHCP).</p> <p>Auto IP: A link-local IP address 169.254.x.x is set.</p> <p>Legacy: The address 192.0.0.192 is set, consistent with older HP Jetdirect devices.</p>

Menu item	Sub-menu item	Sub-menu item	Values and Description
		Primary DNS	Specify the IP address (n.n.n.n) of a Primary DNS Server. NOTE: This item appears only if Manual configuration is a higher priority than DHCP in the Config. Precedence table, configured through the embedded Web server.
		Secondary DNS	Specify the IP address (n.n.n.n) of a Secondary Domain Name System (DNS) Server. NOTE: This item will appear only if Manual configuration is a higher priority than DHCP in the Config. Precedence table, configured through the embedded Web server.
	IPv6 Settings	Enable	Use this item to enable or disable IPv6 operation on the print server. Off: IPv6 is disabled. On (default): IPv6 is enabled.
		Address	Use this item to manually configure an IPv6 address. Manual Settings: Use the Manual Settings menu to enable and manually configure a TCP/ IPv6 address. Enable: Select this item and choose On to enable manual configuration, or Off to disable manual configuration. Address: Use this item to type a 32 hexadecimal digit IPv6 node address that uses the colon hexadecimal syntax.
		DHCPv6 Policy	Router Specified: The stateful auto-configuration method to be used by the print server is determined by a router. The router specifies whether the print server obtains its address, its configuration information, or both from a DHCPv6 server. Router Unavailable: If a router is not available, the print server should attempt to obtain its stateful configuration from a DHCPv6 server. Always: Whether or not a router is available, the print server always attempts to obtain its stateful configuration from a DHCPv6 server.
		Primary DNS	Use this item to specify an IPv6 address for a primary DNS server that the print server should use. NOTE: This item will appear only if Manual configuration is a higher priority than DHCP in the Config. Precedence table, configured through the embedded Web server.
		Secondary DNS	Use this item to specify an IPv6 address for a secondary DNS server that the print server should use. NOTE: This item will appear only if Manual configuration is a higher priority than DHCP in the Config. Precedence table, configured through the embedded Web server.

Menu item	Sub-menu item	Sub-menu item	Values and Description
	Proxy Server		<p>Specifies the proxy server to be used by embedded applications in the device. A proxy server is typically used by network clients for Internet access. It caches Web pages, and provides a degree of Internet security, for those clients.</p> <p>To specify a proxy server, enter its IPv4 address or fully-qualified domain name. The name can be up to 255 octets.</p> <p>For some networks, you may need to contact your Independent Service Provider (ISP) for the proxy server address.</p>
	Proxy Port		<p>Type the port number used by the proxy server for client support. The port number identifies the port reserved for proxy activity on your network, and can be a value from 0 to 65535.</p>
Security	Print Sec Page		<p>Yes: Prints a page that contains the current IPsec security settings on the HP Jetdirect print server.</p> <p>No (default): A security settings page is not printed.</p>
Secure Web			<p>For configuration management, specify whether the embedded Web server will accept communications using HTTPS (Secure HTTP) only, or both HTTP and HTTPS.</p> <p>HTTPS Required: For secure, encrypted communications, only HTTPS access is accepted. The print server will appear as a secure site.</p> <p>HTTP/HTTPS optional: Access using either HTTP or HTTPS is permitted.</p> <p>NOTE: The factory default setting depends on the print server model.</p>
IPSEC			<p>Specify the IPsec or Firewall status on the print server.</p> <p>Keep: IPsec/Firewall status remains the same as currently configured.</p> <p>Disable: IPsec/Firewall operation on the print server is disabled.</p>

Menu item	Sub-menu item	Sub-menu item	Values and Description
Reset Security			<p>Specify whether the current security settings on the print server will be saved or reset to factory defaults.</p> <p>No (default): The current security settings are maintained.</p> <p>Yes: Security settings are reset to factory defaults.</p>
Link Speed			<p>The link speed and communication mode of the print server must match the network. The available settings depend on the device and installed print server. Select one of the following link configuration settings:</p> <p>CAUTION: If you change the link setting, network communications with the print server and network device might be lost.</p> <p>Auto (default): The print server uses auto-negotiation to configure itself with the highest link speed and communication mode allowed. If auto-negotiation fails, either 100TX HALF or 10TX HALF is set depending on the detected link speed of the hub/switch port. (A 1000T half-duplex selection is not supported.)</p> <p>10T Half: 10 Mbps, half-duplex operation.</p> <p>10T Full: 10 Mbps, Full-duplex operation.</p> <p>100TX Half: 100 Mbps, half-duplex operation.</p> <p>100TX Full: 100 Mbps, full-duplex operation.</p> <p>100TX Auto: Limits auto-negotiation to a maximum link speed of 100 Mbps.</p> <p>1000TX Full: 1000 Mbps, full-duplex operation.</p>

Embedded services

Key networking services embedded in the printer are listed below. For the latest features and services, visit <http://www.hp.com/go/jetdirect>.

- Configuration and Management
 - BootP/DHCP (IPv4 only)
 - DHCPv6
 - TFTP (IPv4 only)
 - Web Proxy (Automatic/Manual cURL)
 - LLNMR
 - Telnet (IPv4 only)
 - SNMP (v1, v2c, v3) agents
 - Bonjour (for Mac OS X)

- FTP (File Transfer Protocol)
- WS Discovery (Microsoft Web Services)
- Embedded Web Server, HTTP (TCP port 80)
- Embedded Web Server, HTTPS (TCP port 443)
- IP Security (IPsec)
- **Printing**
 - Raw IP printing (HP-proprietary TCP ports 9100, 9101, 9102)
 - LPD printing (TCP port 515)
 - IPP printing (TCP port 631)
 - FTP printing (TCP ports 20, 21)
 - WS Print (Microsoft Web Services)
- **Security**
 - SNMP v3
 - SSL/TLS
 - 802.1X authentication: WEP, WPA, WPA2, LEAP, PEAP, and EAP-TLS
 - Firewall

Supported network protocols

The supported network protocols, and popular network printing environments that use those protocols, are listed below.





Supported network protocols	Typical network printing environments
TCP/IPv4	(Direct Mode printing) Microsoft Windows XP, Windows Server 2003, and later versions of Windows Microsoft Terminal Server and Citrix MetaFrame environments UNIX and Linux, including: HP HP-UX, Sun Microsystems Solaris (SPARCsystems only), IBM AIX, HP MPE-iX, RedHat Linux, SuSE Linux LPR/LPD (Line Printer Daemon, RFC 1179–compliant) systems IPP (Internet Printing Protocol) FTP (File Transfer Protocol) printing
TCP/IPv6	Microsoft Windows XP, Windows Server 2003, and later versions of Windows, Direct Mode port 9100 printing (requires HP IPv6/IPv4 port monitor software running on the system) LPR/LPD (Line Printer Daemon, RFC 1179–compliant) systems with IPv6 client support IPP (Internet Printing Protocol) systems with IPv6 client support FTP (File Transfer Protocol) printing

5 Personalizing the printer

- [Change the language of the front-panel display](#)
- [Access the HP Utility](#)
- [Access the Embedded Web Server](#)
- [Change the language of the HP Utility](#)
- [Change the language of the Embedded Web Server](#)
- [Change the sleep mode setting](#)
- [Change the auto-off setting](#)
- [Change the loudspeaker volume](#)
- [Change the front-panel display brightness](#)
- [Change the units of measurement](#)
- [Configure network settings](#)
- [Change the graphic language setting](#)
- [Manage printer security](#)
- [Change your printer's email address](#)

Change the language of the front-panel display

There are two possible ways to change the language of the front-panel menus and messages.

- If you can understand the current front-panel display language, press , then , then **Setup > Front panel options > Language**.
- If you cannot understand the current front-panel display language, start with the printer powered off. Press the **Power** key to turn it on. When you see icons appear on the front panel, press  and then . The front panel acknowledges this sequence by turning the icons on and off rapidly.

Whichever method you used, the language selection menu should now appear on the front-panel display. Press your preferred language.

The available languages are English, Portuguese, Spanish, Catalan, French, Italian, German, Polish, Russian, Simplified Chinese, Traditional Chinese, Korean, and Japanese.

Access the HP Utility

The HP Utility enables you to manage your printer from a computer with a TCP/IP or Jetdirect connection.

- **Under Windows**, start the HP DesignJet Utility from your desktop shortcut or from **Start > All Programs > HP > HP DesignJet Utility > HP DesignJet Utility**. This launches the HP DesignJet Utility, showing the printers installed on your computer. When you open the HP DesignJet Utility for the first time, it may offer you an automatic update with enhanced functionality that we recommend you to accept.
- **Under Mac OS X**, launch the HP Utility from your Dock shortcut or by selecting **STARTUP_DISK > Library > Printers > hp > Utilities > HP Utility**. This launches the HP Utility, showing the printers installed on your computer.

When you select your printer in the left pane, everything that appears in the right pane is specific to that printer.

If you have followed these instructions but failed to get through to the HP Utility, see [Cannot access the HP Utility on page 233](#).

Access the Embedded Web Server

The Embedded Web Server enables you to manage your printer remotely using an ordinary Web browser running on any computer.



To access the Embedded Web Server directly, you must have a TCP/IP connection to your printer.

The following browsers are known to be compatible with the Embedded Web Server:

- Internet Explorer 7 for Windows XP, and later
- Safari 3 for Mac OS X 10.5, and later
- Firefox 3.6 and later
- Google Chrome 7 and later

The Adobe Flash plugin version 7 or later is recommended for viewing job previews.

To access the Embedded Web Server on any computer, open your Web browser and give the IP address of your printer.

You can see your printer's IP address on the front panel by pressing  and then .

You can also access the Embedded Web Server from the HP DesignJet Utility or HP Utility.

If you have followed these instructions but failed to get through to the Embedded Web Server, see [Cannot access the Embedded Web Server on page 233](#).

Change the language of the HP Utility

The HP Utility can work in the following languages: English, Portuguese, Spanish, Catalan (Windows only), French, Italian, German, Polish, Russian, Simplified Chinese, Traditional Chinese, Korean and Japanese.



- **Under Windows**, select **Tools > Set Language** and select a language from the list.
- **Under Mac OS X**, the language is changed as for any other application. In **System Preferences**, select **International** and re-launch the application.

Change the language of the Embedded Web Server

The Embedded Web Server can work in the following languages: English, Portuguese, Spanish, Catalan, French, Italian, German, Polish, Russian, Simplified Chinese, Traditional Chinese, Korean and Japanese. It uses whichever language you have specified in your Web browser's options. If you have specified a language that it cannot support, it works in English.

To change the language, you must change your Web browser's language setting. For example, in Internet Explorer, go to the **Tools** menu and select **Internet Options > Languages**. Then ensure that the language you want is at the top of the list in the dialog box.



Change the sleep mode setting

If the printer is left switched on but unused for a certain period of time, it goes automatically into sleep mode to save power. To change the time the printer waits before it goes into sleep mode, go to the front panel and press , then , then **Setup > Front panel options > Sleep mode wait time**. Select the wait time you want and then press **OK**; you can set the time from 1 to 240 minutes. The default time is 30 minutes.



Change the auto-off setting

To help save energy, the printer is supplied with an auto-off (automatic power management) feature enabled, which turns the printer off automatically after a period of inactivity. However, when the printer is connected to a network, the auto-off feature is automatically disabled, to avoid inconveniencing network users.



 **NOTE:** The auto-off feature is different from sleep mode: it turns the printer off completely. To turn it back on, use the [Power](#) button as usual.

You can configure the auto-off feature from the front panel: you can set it to turn off the printer after 2 to 12 hours of inactivity, or disable auto-off entirely. Press , then , then **Setup > Front panel options > Auto-off**.



Change the loudspeaker volume

To change the volume of the printer's loudspeaker, go to the front panel and press , then , then **Setup > Front panel options > Speaker volume**, and select Off, Low, or High.

Change the front-panel display brightness

To change the brightness of the front-panel display, press , then , then **Setup > Front panel options > Display brightness**, and select a value you want. Press **OK** to set the value. The default brightness is set to 50.

Change the units of measurement

To change the units of measurement in the front-panel display, press , then , then **Setup > Front panel options > Unit selection**, and select **English** or **Metric**. By default the units are set to metric.

Configure network settings

You can view and configure the network settings from the Embedded Web Server, the HP Utility or the front panel.

To do so with the Embedded Web Server, select the **Networking** tab.

With the HP DesignJet Utility under Windows, select the **Admin** tab, then **Network Settings**. Under Mac OS X, select **Configuration > Network Settings**.

The following settings are available.

- **IP Configuration method:** Specify the way to set an IP address, selecting **BOOTP**, **DHCP**, **Auto IP** or **Manual**.
- **Host name:** Specify the IP name of the printer. The name may contain up to 32 ASCII characters.
- **IP address:** Specify the IP address of the printer. Duplicate IP addresses on a TCP/IP network will cause communication to fail.

 **TIP:** Make sure that the combination of IP address, subnet mask and default gateway is valid. If these three fields are inconsistent, you may not be able to connect to the printer at all until you fix the problem from the front panel.



TIP: If you change the current IP address and click **Apply**, the browser loses the current connection to the printer because it is pointing to the old address. To reconnect, browse to the new IP address.

- **Subnet mask:** Specify a subnet mask, which determines which bits specify the network and which bits uniquely specify the node within the network.
- **Default gateway:** Specify the IP address of a router or computer that is used to connect to other networks or sub-networks. If none exist, use the IP address of the computer or the IP address of the printer.
- **Domain name:** Specify the name of the DNS domain in which the printer resides (for example, support.hp.com).



NOTE: The domain name does not include the host name: it is not the fully qualified domain name, such as printer1.support.hp.com.

- **Idle timeout:** Specify the time that an idle connection is allowed to remain open when a remote computer is waiting for the printer. The default value is 280 seconds. If set to zero, the timeout is disabled and the connection is allowed to remain open indefinitely.
- **Default IP:** Specify the IP address to use when the printer is unable to obtain an IP address from the network when powered on or when reconfigured to use BOOTP or DHCP.
- **Send DHCP requests:** Specify whether DHCP requests are transmitted when a legacy default IP address or a default Auto IP is assigned.

To configure the same network settings from the front panel, press , then , then **Connectivity > Network connectivity > Gigabit Ethernet > Modify configuration**.



You have various other options available from the **Connectivity > Network connectivity > Advanced** menu.

- **Allow SNMP:** Specify whether SNMP is permitted.
- **Embedded Web Server > Allow EWS:** Specify whether the Embedded Web Server is enabled.
- **Web Services > HP Utility software:** Enable or disable the HP Utility.
- **Web Services > Color and paper management:** View the color and paper management settings.
- **Restore factory settings:** restore the initial default values of the network settings.

Change the graphic language setting

You can change the graphic language setting by launching the Embedded Web Server from the HP Utility with the following steps.

1. **Under Windows**, select the **Admin** tab, then **Printer settings > Printing preferences**.
Under Mac OS X, select **Configuration** then **Printer settings > Configure printer settings > Printing preferences**.
2. Select one of the following options.
 - Select **Automatic** to let the printer determine which type of file it is receiving. This is the default setting; it works for most software applications. You should not normally need to change it.
 - Select **HP-GL/2** only if you are sending a file of that type directly to the printer, without going through a printer driver.
 - Select **PDF** only if you are sending a file of that type directly to the printer, without going through a printer driver (PostScript printers only).
 - Select **PostScript** only if you are sending a file of that type directly to the printer, without going through a printer driver (PostScript printers only).
 - Select **TIFF** only if you are sending a file of that type directly to the printer, without going through a printer driver (PostScript printers only).
 - Select **JPEG** only if you are sending a file of that type directly to the printer, without going through a printer driver (PostScript printers only).

Alternatively, you can change the graphic language setting from the front panel. Press , then , then **Setup > Printing preferences > Graphics language**. Select the desired option.



NOTE: If the graphic language is set from the Embedded Web Server, it overrides the front panel setting.

Manage printer security

When you have set up Web Services, the printer is in unlock mode. In unlock mode, anyone who knows your printer's email address can print to your printer by just sending a file to it. Although HP provides a spam filtering service, you should be careful about giving out your printer's email address, as everything sent to that address may be printed on your printer.

If you are the printer administrator, you can manage printer security or change your printer status to lock mode by visiting HP Connected at <http://www.hpconnected.com>. You can also manage print jobs from there. At your first visit, you will need to create an account in HP Connected.

Change your printer's email address

You can change your printer's email address at HP Connected: <http://www.hpconnected.com>.

6 Paper handling

- [General advice](#)
- [Load a roll onto the spindle](#)
- [Load a roll into the printer](#)
- [Unload a roll](#)
- [Load a single sheet](#)
- [The stacker](#)
- [The basket](#)
- [View information about the paper](#)
- [Paper presets](#)
- [Printing paper info](#)
- [Move the paper](#)
- [Maintain paper](#)
- [Change the drying time](#)
- [Change the retrieval time](#)
- [Turn the automatic cutter on and off](#)
- [Feed and cut the paper](#)

General advice

⚠ CAUTION: Before starting a paper loading process, ensure that you have enough room around the printer, both in front and behind. You need at least enough space behind the printer to open the basket fully.

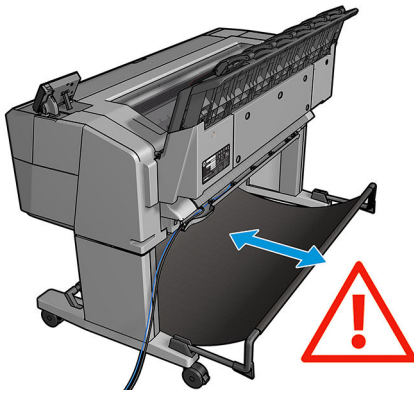

⚠ CAUTION: Ensure that the printer wheels are locked (the brake lever is pressed down) to prevent the printer from moving.

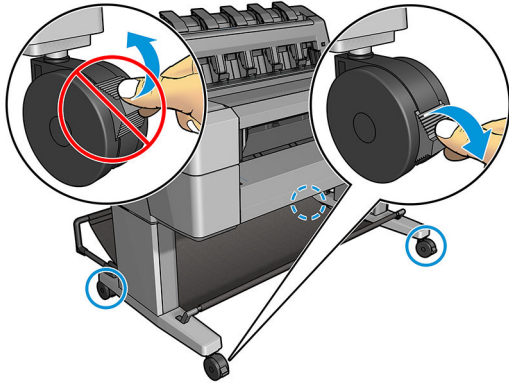

⚠ CAUTION: All paper must be 280 mm (11 in) or longer. A4 and letter paper cannot be loaded in landscape orientation.

💡 TIP: For photo paper wear cotton gloves to avoid transferring oils onto the paper.

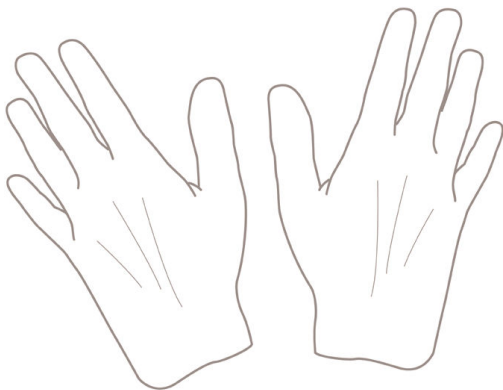

Load a roll onto the spindle

1. Open the roll cover.

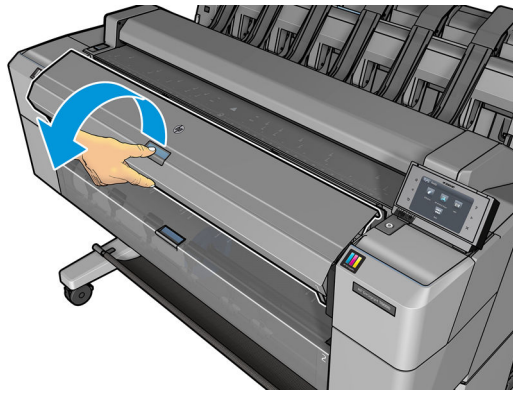

2. Remove the black end of the spindle from the printer, then the blue end.

⚠ CAUTION: Be sure to remove the black end first. Removing the blue end first could damage the black end.

⚠ WARNING! Do not insert your fingers into the spindle supports during the removal process.

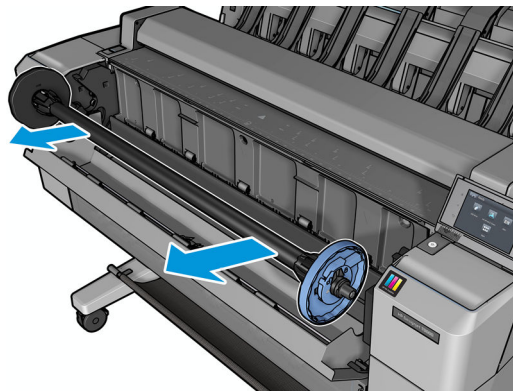

3. The spindle has a stop at each end. The blue stop can move along the spindle and has a latch to lock it in place. Open the latch and remove the blue stop from the end of the spindle.

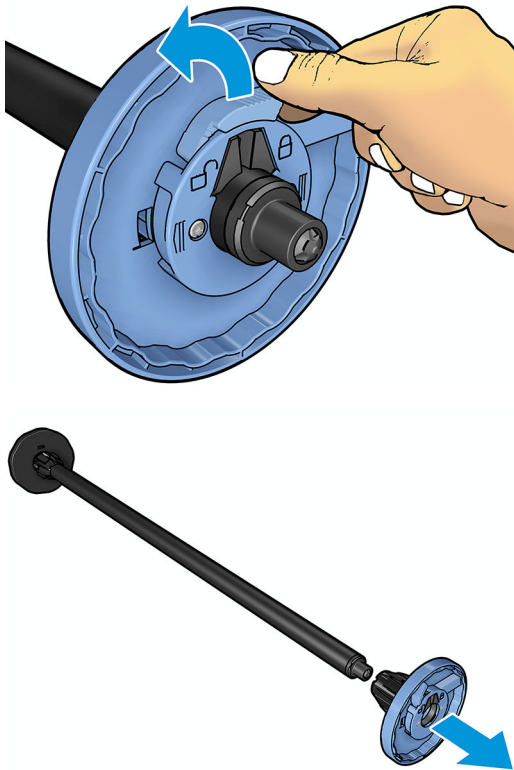

4. If there is already a roll or core on the spindle, remove it.
5. If the roll is long, rest it horizontally on a table and insert the spindle into it.

 **TIP:** You may need two people to handle a large roll.

6. Slide the new roll onto the spindle. Make sure the paper type is oriented as shown. If it is not, remove the roll, turn it 180 degrees and slide it back on to the spindle. There are labels on the spindle showing the correct orientation.

 **NOTE:** From the front of the printer, the blue stop should be inserted into the right-side holder.

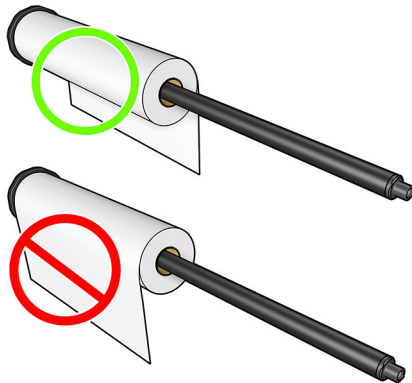

- Put the blue stop onto the open end of the spindle, and push it towards the end of the roll.

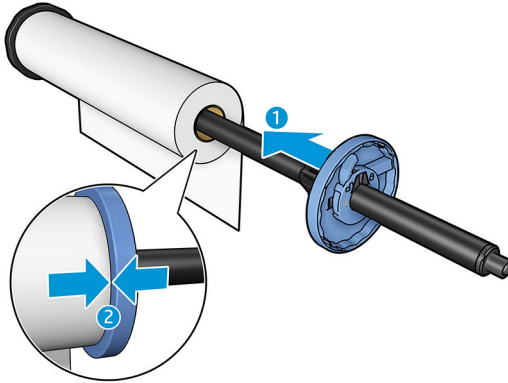

- Ensure that the blue stop is pushed in as far as it goes; until both ends are against the stops, then close the latch.

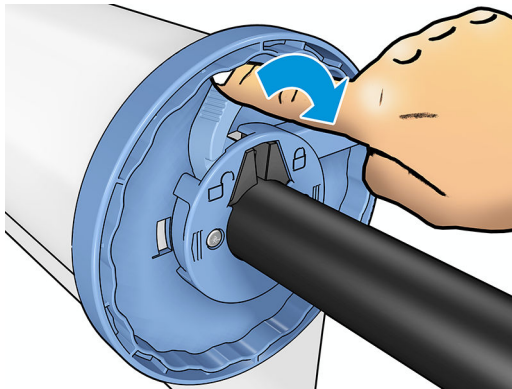



If you are a regular user of different paper types, you can change rolls more quickly if you preload rolls of different paper types on different spindles. Extra spindles are available for purchase, see [Supplies and accessories on page 165](#).

Load a roll into the printer

To start this procedure, you must have a roll loaded on the spindle. See [Load a roll onto the spindle on page 52](#).

TIP: Do not try to open both roll covers at once; this may cause problems. Always close one cover before opening the other.

NOTE: The first two steps below are optional: you can start with step 3. However, in this case the printer will not keep track of the length of the roll, and will print no barcode on the roll when it is next unloaded. So you are recommended to follow all the steps, starting with step 1, unless you have turned off the **Printing paper info** option. See [Printing paper info on page 64](#).

- From the front panel, press , then  if it is not already highlighted, then the roll icon, then **Load**.

Alternatively, press , then , then **Paper > Paper load > Load roll 1 or Load roll 2**.

If the roll you have selected is already loaded, you have to wait while it is automatically unloaded.

2. If you start to load roll 1 while roll 2 is already loaded, roll 2 is withdrawn to the standby position, so that it can be printed on again without reloading whenever required (and vice versa).

 **NOTE:** If at any time you open a roll cover while that roll is loaded but not printing, the roll will be automatically unloaded, and you will have to reload it the next time you want to print on it.

3. Open the roll cover.

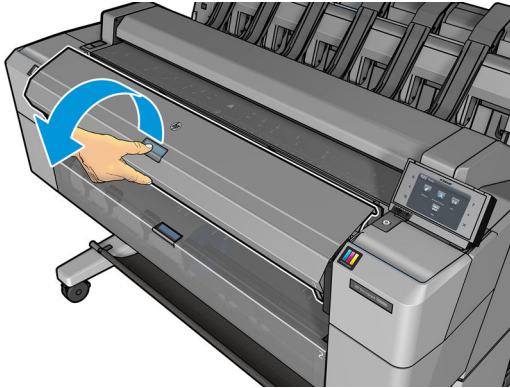

4. Load the spindle into the printer, with the blue stop on the right. Hold the spindle by its ends and not in the middle, to avoid touching the paper and perhaps leaving marks on it.

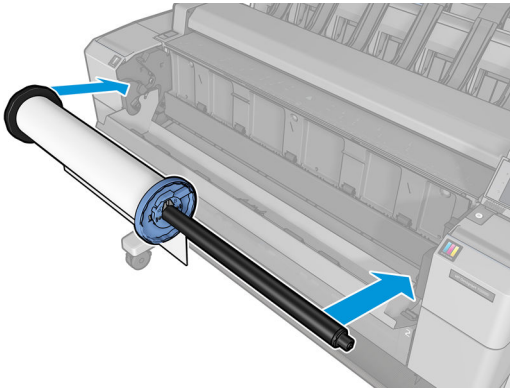

5. If the edge of the roll is not straight or torn (sometimes due to tape used to hold end of the roll), pull the paper slightly and cut a straight edge.

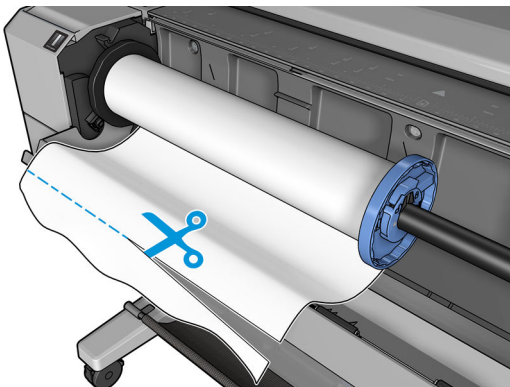

6. Insert the edge of the paper into the printer.

⚠ WARNING! Do not push your fingers inside the printer's paper path.

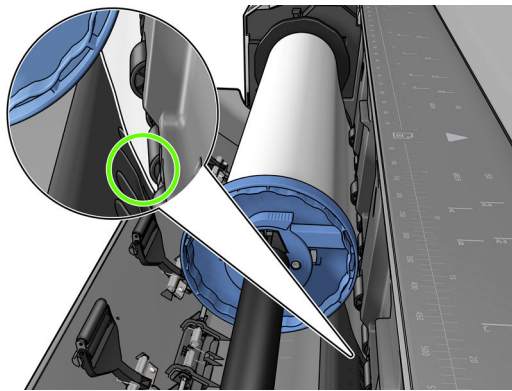
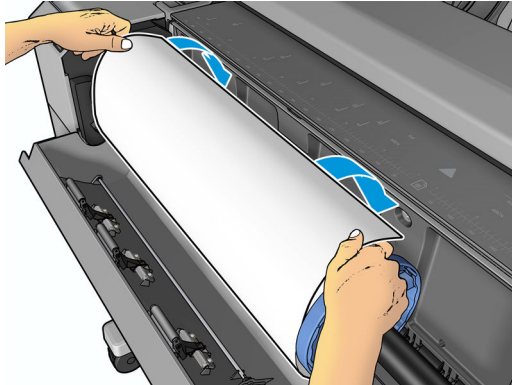

7. Roll the paper into the printer until you feel resistance and the paper flexes slightly. When the printer detects the paper, it feeds it in automatically.

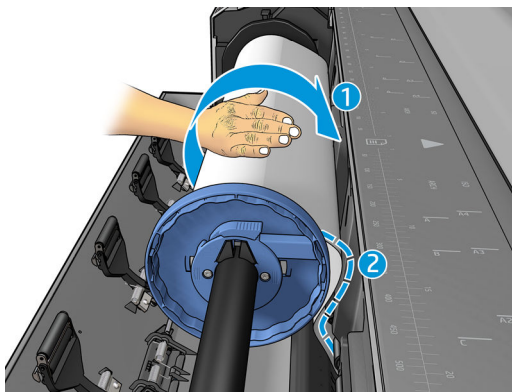

8. If the leading edge of the paper has a barcode, the printer reads and then cuts off the barcode, which falls into the basket.
9. If the leading edge of the paper has no barcode, the front panel prompts you to select the paper category and type.

💡 TIP: If you have loaded a paper type whose name does not appear in the paper list, see [The paper type is not in the list on page 170](#).

10. If the **Printing paper info** option is enabled, the front panel may ask you to specify the length of the roll. See [Printing paper info on page 64](#).
11. Close the roll cover when the front panel prompts you to do so.

 **NOTE:** If you have an unexpected issue at any stage of the paper loading process, see [The paper cannot be loaded successfully on page 169](#).

Unload a roll

Before unloading a roll, check whether there is paper on the roll or if the roll is out of paper, and follow the appropriate procedure as described below.

Quick procedure with paper on the roll

If there is paper on the roll, just open the roll cover, and the roll is unloaded automatically. The front panel prompts you to load a new roll or sheet.

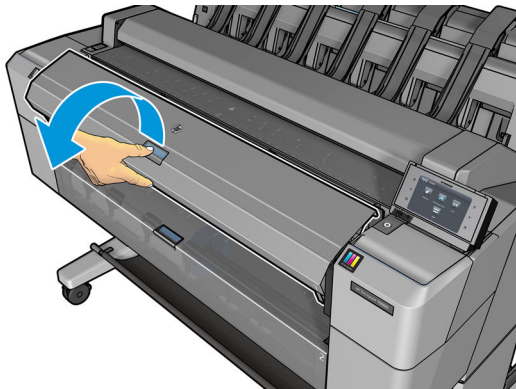



 **NOTE:** When the roll is unloaded in this way, no barcode is printed on it, so the printer will not know the length of the roll when it is next loaded. See [Printing paper info on page 64](#).

 **NOTE:** If you open the a roll cover while a sheet is loaded, the sheet is also unloaded.

Front panel procedure with paper on the roll

If there is paper on the roll, you can unload it from the front panel.

1. Press  , then  if it is not already highlighted, then the roll icon, then **Unload**.

Alternatively, press  , then  , then **Paper > Paper unload > Unload roll 1** or **Unload roll 2**.

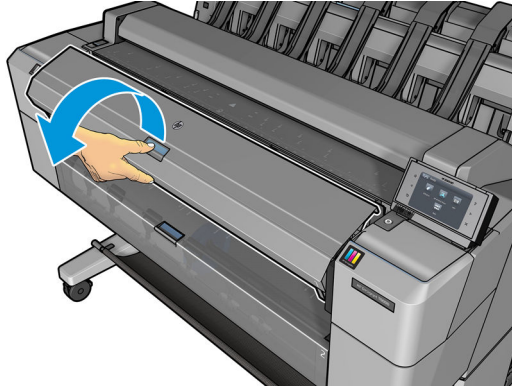

2. You may need to open the roll cover.



Load a single sheet

1. Ensure that both roll covers are closed. If a roll cover is opened while a sheet is loaded, the sheet is immediately unloaded.

WARNING! Do not load the sheet before starting the loading process from the front panel.

2. At the front panel, press , then  if it is not already highlighted, then the sheet icon, then **Load > Load sheet**.

Alternatively, press , then , then **Paper > Paper load > Load sheet**.

3. If a roll is already loaded, you have to wait while it is automatically unloaded. The roll is not unloaded, but withdrawn to the standby position, so that it can be printed on again without reloading as soon as the sheet paper has been unloaded.

NOTE: If at any time you open a roll cover while that roll is loaded but not printing, the roll will be automatically unloaded, and you will have to reload it the next time you want to print on it.

4. Select your paper category and type.

TIP: If you have loaded a paper type whose name does not appear in the paper list, see [The paper type is not in the list on page 170](#).

5. When prompted by the front panel, insert the sheet into the front of the printer.

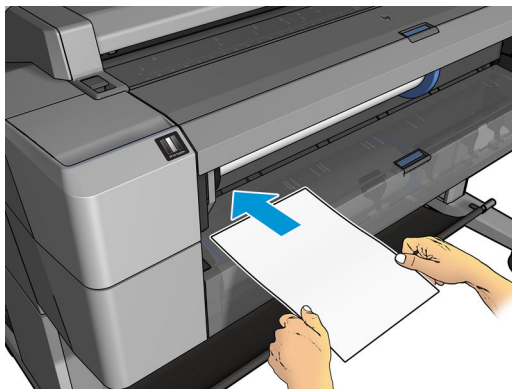

- Align the left-hand edge of the sheet with the blue line on the left-hand side of the printer.

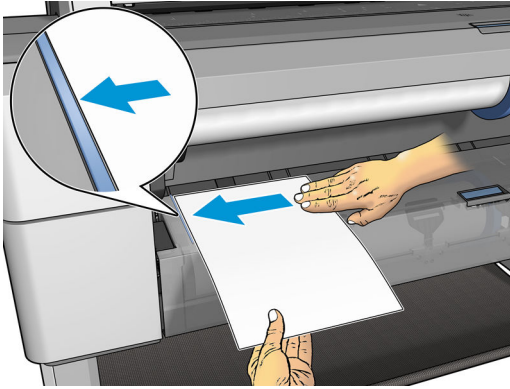

- Push the sheet into the printer until it will not go any further.

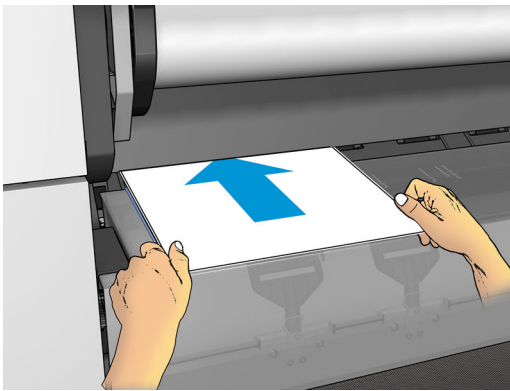

⚠ WARNING! Do not push your fingers inside the printer's paper path.

- Guide the sheet into the printer until the printer beeps and starts pulling the paper.
- The printer checks the alignment.
- If the sheet is not correctly aligned, it is ejected, and you will have to try again.

📝 NOTE: If you have an unexpected problem at any stage of the paper loading process, see [The paper cannot be loaded successfully on page 169](#).

The stacker

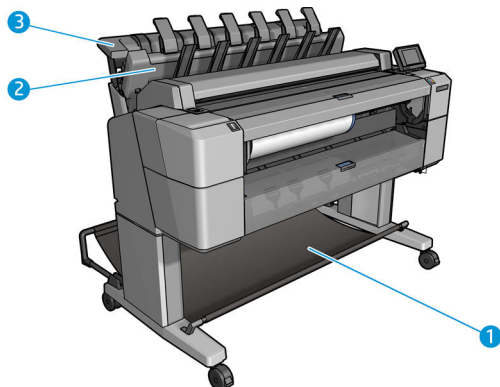

1. Basket
2. Stacker pivoting cover
3. Stacker

By default, the printer cuts the paper after every print job. The resulting printed sheet of paper is neatly stacked on top of the other printed sheets by the stacker.

To empty the stacker, stand in front of the printer and pull the stack of printed sheets out of the stacker. The stacker cover may open during this process; make sure that it is closed after you have removed the sheets. Normally the return spring will close it automatically.

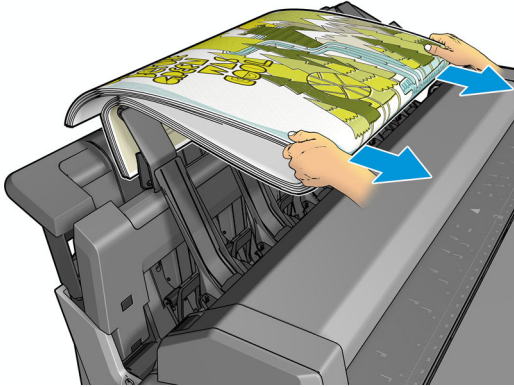

TIP: Although you can remove sheets from the stacker while the printer is printing, you are recommended to remove all the prints together while the printer is not printing.

TIP: You can lock the stacker cover in the open position to collect special jobs. Make sure that you close it afterwards.

TIP: If you want to use a photo paper for printing in normal printing mode to the stacker, you are recommended to use an HP Instant-Dry Photo Paper.

TIP: For stacking papers below 75 gr/m² activate the blue separators located in the laterals of the stacker cover. Make sure you deactivate them when using the rest of papers.

Manual printing with the stacker open

The stacker's manual printing mode is designed to be used when you want the highest-quality print possible on photo paper, and you are willing to stand in front of the printer to ensure it.

You can choose manual mode either for a particular job (for example, from the printer driver), or by putting the printer into manual mode from the front panel.

- If you send a job with manual mode selected, the job is put on hold, and other jobs can continue printing, until you select it for printing from the front panel (the front panel can guide you through this process) and open the stacker cover.

Print & Copy jobs	Scan jobs		
⚠ HPSC0025.tif			On hold
⚠ HPSCN0080			Hold for preview
📄 HPSCN0011			On hold for manual mode
✅ HPSC0335.pdf			Printed
✅ HPSCN0018			Printed

- If you put the printer into manual mode from the front panel, all jobs in the queue are put on hold for manual mode, and you can print them from the queue. When you exit manual mode, any jobs still in the queue return to their previous status.

 **NOTE:** When opening the stacker to enter manual mode, lock the stacker cover into the open position.

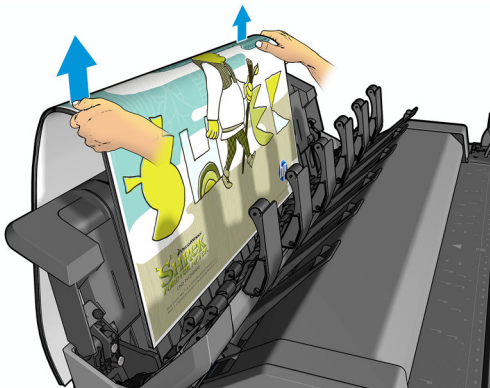
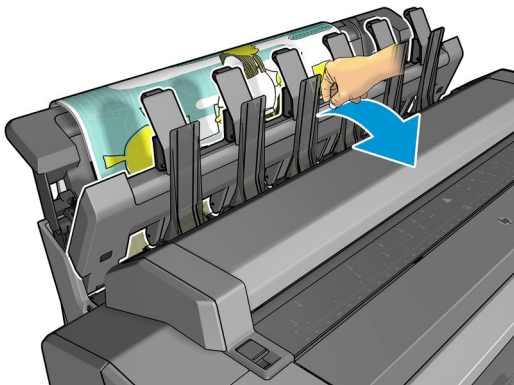

In manual mode:

- You can print only one page at a time. You must start each page manually from the front panel.
- You print with the stacker cover open, and stand in front of the printer to check the print as it emerges.
- With the stacker cover open, you have a better view of the print as it emerges, but the stacker cannot guarantee that the print will follow the correct paper path, so you must watch over it to prevent possible damage.
- You cannot scan or copy because the stacker cover is blocking the scanner.

- If the printer is left idle and in manual mode for more than 15 minutes, manual mode is cancelled, and you are advised to close the stacker.
- You can exit manual mode from the front panel or by closing the stacker.

Manual mode is indicated in various front-panel screens by the  icon.

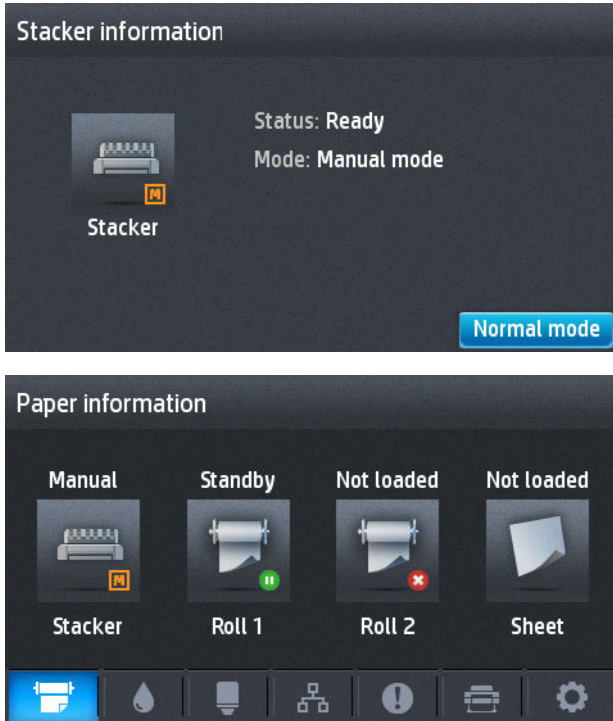



The basket

The stacker is normally used to collect prints. If you decide not to use the stacker, you can send your prints to the basket. You may decide to use the basket if the stacker is full, or if you want to separate a job from the other jobs printed to the stacker.

The basket can accept up to 10 A1 or D-sized sheets of bond paper. Larger prints should be removed from the basket immediately after printing.

 **TIP:** Ensure that you have routed all cables correctly, so that they do not interfere with paper falling into the basket. Otherwise you may experience paper jams.

View information about the paper

To view the loaded paper information, press , then  if it is not already highlighted, then the roll icon.

The following information is displayed on the front panel:

- The paper type you have selected
- Roll or sheet status
- Width of the paper in millimeters (estimated)

The same information is displayed in the HP DesignJet Utility for Windows (**Overview** tab > **Supplies** tab) and the HP Utility for Mac OS X (Information group > **Supplies Status**).

Paper presets

Each supported paper type has its own characteristics. For optimum print quality, the printer changes the way it prints on each different paper type. For example, some may need more ink and some may require a longer drying time. So the printer must be given a description of the requirements of each paper type. This description is called the *paper preset*. The paper preset contains the ICC profile, which describes the color characteristics of the paper; it also contains information on other characteristics and requirements of the paper that are not directly related to color. Existing paper presets for your printer are already installed in the printer's software.

However, as it is inconvenient to scroll through a list of all paper types available, your printer only contains paper presets for the most commonly used paper types. If you have a paper type for which your printer has no preset, you cannot select that paper type in the front-panel display.

There are two ways to assign a preset for a new paper type.

- Use one of the existing HP factory paper presets by selecting the closest category and type in the front panel or the printer driver. See [The paper type is not in the list on page 170](#).



NOTE: Colors may not be accurate. This method is not recommended for high-quality prints.

- Download the correct paper preset from <http://www.hp.com/go/T2500/paperpresets>.



NOTE: HP provides presets for HP paper types only. If you do not find the paper preset you want on the Web, you may find that it has been added to the latest firmware for your printer. You can check the firmware release notes for information, see [Update the firmware on page 151](#).

Printing paper info

Enable the **Printing paper info** option to record the printer's estimate of the remaining roll length, paper width and type. The information is a combination of barcode and text that is printed on the leading edge of the roll when the paper is unloaded from the printer.

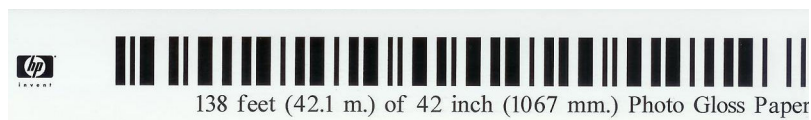



NOTE: The paper-length estimate is available only if the printer registered the amount of paper that was on the roll when you loaded it. To provide this information to the printer, specify the roll length on the front panel when loading the paper, or load a roll that has the paper-data barcode printed on it.



NOTE: The barcode and text are printed on the roll only when the loading and unloading processes are started from the front panel's Paper menu.



NOTE: This option can be expected to work only with papers that are completely opaque. It may fail with transparent or translucent papers.



To enable the **Printing paper info** option, go to the front panel and press , then , then **Setup** > **Printing preferences** > **Paper options** > **Printing paper info**.



NOTE: Enabling this option slightly changes the paper loading and unloading procedures.

Move the paper

If the printer is idle (ready to print), you can move the paper forwards or backwards from the front panel. You may want to do this in order to have more or less white space between the last print and the next one when the cutter is disabled; or to increase top margin of the next print.

To move the paper, press , then , then **Paper > Move paper**.

Maintain paper

To maintain paper quality, follow the recommendations below.

- Store rolls covered by another piece of paper or cloth
- Store cut sheets covered and clean or brush them before loading them in the printer
- Clean input and output platens
- Keep the scanner lowered unless you need to lift it for some reason

 **NOTE:** Photo and coated paper requires careful handling, see [The print is scuffed or scratched on page 188](#).

Change the drying time

You may wish to change the drying time setting to suit special printing conditions such as multiple prints where time is of higher importance or when you need to be sure ink is dry before handling.

Press , then , then **Setup > Print retrieval > Drying time**. You can select:

- **Extended**, to set a longer than recommended time to ensure ink is completely dry
- **Optimal**, to set the default and recommended time for your selected paper (this is the default setting)
- **Reduced**, to set a shorter than recommended time when quality is of lower importance
- **None**, to disable the drying time and remove your print as soon as it finishes printing

 **CAUTION:** If the ink is not dry when the print is removed it could leave ink in the output tray and marks on the print.

 **NOTE:** If you cancel the drying time during a print, the printer may not feed and cut the paper right away due to the printhead maintenance, which runs in parallel. If the dry time is zero, the printer cuts the paper and then performs the printhead maintenance. However, if the dry time is greater than zero, the printer does not cut the paper until after the printhead maintenance has completed.



Change the retrieval time

You may wish to add some time after drying in which you can pick up the print before the next job starts.

Press , then , then **Setup > Print retrieval > Retrieval time**.

Turn the automatic cutter on and off

To turn the printer's paper cutter on or off:



- From the HP DesignJet Utility for Windows, select the **Admin** tab and change the **Cutter** option in **Printer Settings > Advanced**.
- From the Embedded Web Server, select the **Setup** tab, then **Printer Settings > Advanced**, and change the **Cutter** option.
- From the front panel, press , then , then **Setup > Print retrieval > Cutter**.

The default setting is **On**.

If the cutter is turned off, it does not cut the paper between jobs, but continues to cut the paper on loading, unloading, switching between rolls, and switching between the stacker and the basket.

 **TIP:** To cut roll paper while the automatic cutter is disabled, see [Feed and cut the paper on page 66](#).

Feed and cut the paper

If you go to the front panel and press , then , then **Paper > Form feed and cut**, the printer advances the paper and makes a straight cut across the front edge. There are several possible reasons why you might want to do this.

- To trim the leading edge of the paper if it is damaged or not straight. The cut strip falls into the basket.
- To feed and cut the paper when the automatic cutter has been disabled.
- To cancel the waiting time and print the available pages immediately, if the printer is waiting to nest more pages.

 **NOTE:** The printhead is serviced after each print, and the paper cannot be cut until the process completes, so you may notice a delay.

 **NOTE:** Photo and coated paper requires careful handling, see [The print is scuffed or scratched on page 188](#).

 **TIP:** To move the paper without cutting it, see [Move the paper on page 65](#).



7 Working with two rolls

The uses of a multiroll printer

A multiroll printer can be useful in several different ways:

- The printer can automatically switch between different paper types according to your needs.
- The printer can automatically switch between different paper widths according to your needs. This enables you to save paper by printing smaller images on narrower paper.
- If you load two identical rolls into the printer, you can leave it printing unattended for a long time, because it can switch from one roll to the other automatically when the first is exhausted. See [Unattended printing/overnight printing on page 84](#).

When working with multiple rolls, bear in mind that a **protected roll** is protected from use unless the roll number or its paper type are specifically requested. See [Roll protection on page 83](#).

The current status of both rolls is shown on the front panel if you press , then  if it is not already highlighted.

 **NOTE:** When you print from a USB flash drive, multiroll printing is considerably simplified: either you specify manually which roll you want to use, or you can select **Save paper**, in which case the printer chooses the narrowest roll on which the print will fit. You cannot specify the paper type.

How the printer allocates jobs to paper rolls

When you submit a print job from the Embedded Web Server or the printer driver, you can specify (using the **Paper type** or **Type is** option) that you want it to be printed on a particular paper type; you can even specify (using the **Paper source**, **Source is** or **Paper Feed** option) that you want it to be printed on a particular roll (1 or 2). The printer will try to satisfy these requirements, and it will also look for a paper roll large enough to print the image without clipping.

- If both rolls are suitable for the job, the roll will be chosen according to the roll switching policy. See [Roll switching options on page 29](#).
- If just one of the rolls is suitable for the job, it will be printed on that roll.
- If neither roll is suitable for the job, it will be held in the job queue with the status “On hold for paper”, or printed on an unsuitable roll, depending on the paper mismatch action. See [Paper mismatch action on page 28](#).

The printer driver for Windows will tell you which paper types and widths are currently loaded in the printer, and on which rolls.

Here are some settings that may be used in typical situations.



NOTE: The **Type is** and **Source is** settings are in the printer driver and the Embedded Web Server; the **Roll switching policy** is set in the front panel.

- With different paper types loaded:
 - **Type is:** Select the paper type you require
 - **Source is:** Automatically select / Predetermined
 - **Roll switching policy:** doesn't matter
- With different paper widths loaded:
 - **Type is:** Use printer settings
 - **Source is:** Automatically select / Predetermined
 - **Roll switching policy:** Minimize paper waste



TIP: You can also save paper in some cases by rotating or nesting your images. See [Use paper economically on page 81](#).

- With identical rolls loaded:
 - **Type is:** Use printer settings
 - **Source is:** Automatically select / Predetermined
 - **Roll switching policy:** Minimize roll changes

8 Printing

- [Introduction](#)
- [Print from a USB flash drive](#)
- [Print from a computer using the Embedded Web Server or HP Utility](#)
- [Print from a computer using a printer driver](#)
- [Advanced print settings](#)
- [Print from iOS with AirPrint](#)

Introduction

There are various different ways in which you can choose to print, depending on your circumstances and preferences.

- Print a TIFF, JPEG, HP-GL/2, RTL, PDF or PostScript file directly from a USB flash drive. See [Print from a USB flash drive on page 70](#).
- Print a file that is already in the job queue. See [Reprint a job from the queue on page 97](#).
- Print a TIFF, JPEG, HP-GL/2, RTL, PDF or PostScript file directly from a computer connected to the printer, using the Embedded Web Server or the HP Utility. See [Print from a computer using the Embedded Web Server or HP Utility on page 71](#).
- Print any kind of file from a computer connected to the printer by network, using a software application that can open the file, and a printer driver supplied with your printer. See [Print from a computer using a printer driver on page 73](#).
- Print using AirPrint from a device that supports it. See [Print from iOS with AirPrint on page 84](#).
- See also [Mobile printing on page 92](#).



 **NOTE:** To print PDF or PostScript files, a PostScript printer is required.

Print from a USB flash drive

1. Insert a USB flash drive containing one or more TIFF, JPEG, HP-GL/2, RTL, PDF or PostScript files into the printer's USB port.



 **NOTE:** To print PDF or PostScript files, a PostScript printer is required.

 **NOTE:** The use of USB flash drives with your printer may be disabled by the administrator: see [Control access to the printer on page 32](#).

2. At the front panel, go to the home screen and press  , then  .
3. Select the file to be printed. Files that cannot be printed are indicated with  . You can press folders to browse their contents.
4. The default print settings are displayed. If you want to change them, press **Settings**. The following settings are available:
 - **Size** allows you to resize the print in two different ways: to a percentage of its original size, or to fit a particular paper size. The default is 100% (its original size).
 - **Color** allows you to choose color, grayscale, or black-and-white printing.
 - **Print quality** allows you to set the print quality to **Best**, **Normal** or **Fast**.
 - **Roll** allows you to specify printing on roll 1 or roll 2, or you can choose **Save paper**, which automatically chooses the narrowest roll on which the print will fit (if two rolls are loaded).
 - **Manual mode** allows you to enable manual printing with the stacker open for this job (it is disabled by default).

- **Paper output** allows you to direct output to the stacker (the default) or the basket
- **Collate** allows you to turn collation on or off
- **Page order**: allows you to choose first page on top, or last page on top
- **Rotation** allows you to rotate the print by any multiple of 90°, or you can choose **Automatic**, which rotates the print automatically if that will save paper.
- **Printer margins** allows you to change the default printer margins.



NOTE: If you change the settings in this way, the changed settings apply to the current job but are not saved permanently. You can change the default settings, except for the **Output** setting, by pressing , then , then **Print from USB preferences**.

5.

To display a preview of the printed job on the front panel, press  .

When the preview is displayed, you can press it to zoom in on it. Press it again to zoom out.

6.

When you are satisfied with the print settings, press **Start**.

7.

After printing, you can choose to print another file or go to the job queue. If you print another file immediately without returning to the home screen, the temporary settings used for the previous file are used again.

Print from a computer using the Embedded Web Server or HP Utility

You can print files in this way from any computer that can access the printer's Embedded Web Server. See [Access the Embedded Web Server on page 46](#).

From the Embedded Web Server, select the **Main** tab and then **Submit job**. From the HP Utility, select **Job Center** > **Submit Job**. You will see the window below.

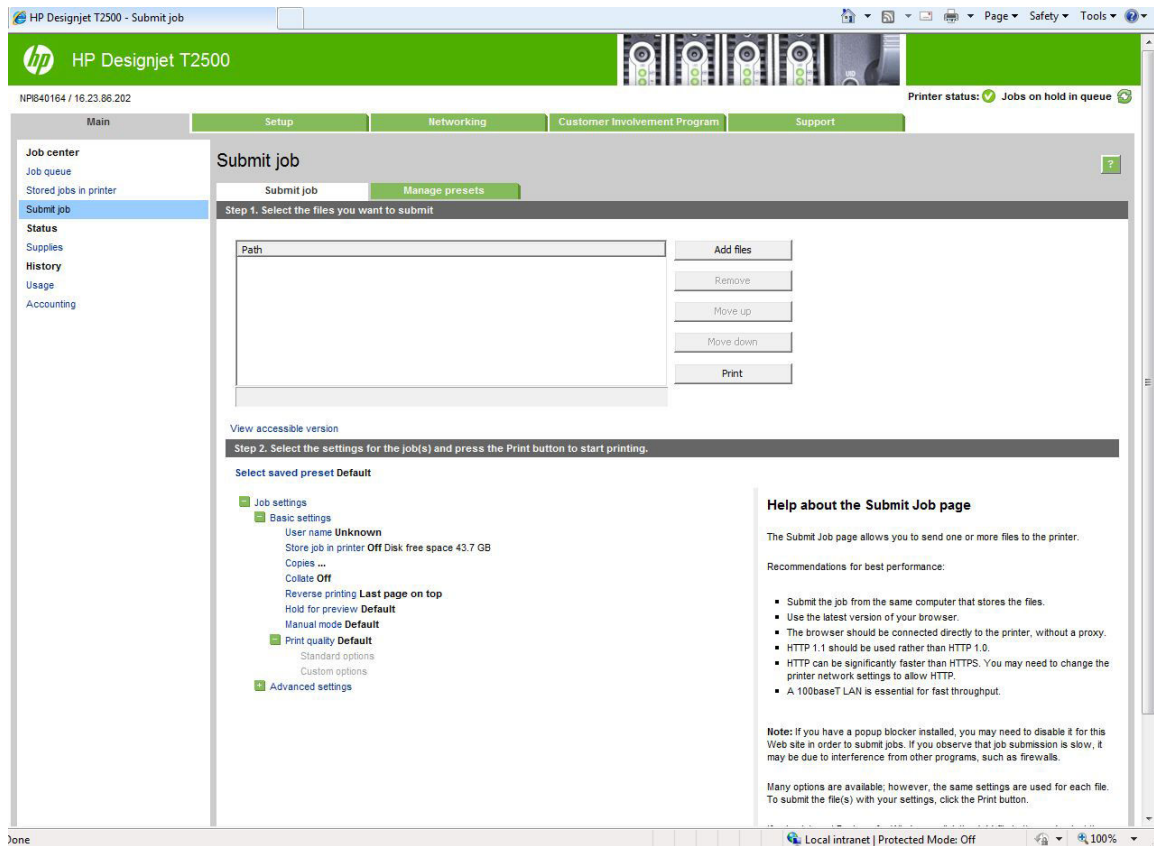

Press the **Add files** button to choose the files from your computer that you want to print. The files must be in one of the following formats:

- HP-GL/2
- RTL
- TIFF
- JPEG
- PDF (PostScript printers only)
- PostScript (PostScript printers only)



NOTE: When you print to a file, the file should be in one of the above formats, but its name may have an extension such as **.plt** or **.prn**.

If the files are not in one of these formats, they will not be printed successfully.

If the jobs have been generated with the appropriate settings (such as page size, rotation, resizing and number of copies), you can just press the **Print** button and they will be sent to the printer.

If you need to specify printing settings, go to the **Job settings** section and select the options you need. Each option has explanatory text on the right, so that you can understand the behavior of each setting. Remember that, if you leave the setting as **Default**, the setting saved in the job will be used. If the job contains no setting, the setting in the printer will be used.

If you have chosen some non-default settings and expect to reuse the same group of settings in the future, you can save them all under a single name from the **Manage presets** tab, and recall them using that name later.

Print from a computer using a printer driver

This is the traditional way of printing from a computer. The correct printer driver must be installed on the computer (see [Installing the software on page 15](#)), and the computer must be connected to the printer by network.

When the printer driver has been installed and the computer is connected to the printer, you can print from a software application by using the application's own **Print** command and selecting the correct printer.

 **NOTE:** When first printing, Windows automatically searches for the printer driver on the Internet (if the computer is connected to the Internet). This means that you do not need to search for the driver yourself. However, this process will install the driver without the rest of the software. Therefore, we recommend installation using the DVD (or the install package that you can download from HP's website) so that all of the printer software is installed.

Advanced print settings

The rest of this chapter explains the various print settings that you can use when printing with a printer driver, the Embedded Web Server or the HP Utility. These methods offer a relatively large number of settings in order to satisfy all requirements.

 **TIP:** In general you are recommended to use the default settings unless you know that they do not meet your requirements.

TIP: If you intend to reuse a particular group of settings repeatedly, you can save those settings under a name of your own choice and recall them later. A saved group of settings is known as a 'quick set' in the Windows printer driver, and as a 'preset' in the Embedded Web Server.

Select print quality

The printer has various print-quality options because best-quality printing requires some loss of speed, while fast printing implies some reduction in print quality.



Therefore, the standard print-quality selector is a slider that allows you to choose between quality and speed. With some paper types, you can choose a compromise position between the two.

Alternatively, you can select from the custom options: **Best**, **Normal** and **Fast**. If you select **Fast**, you can also select **Economode**, which uses a lower rendering resolution and consumes less ink. It therefore increases printing speed even further, but reduces print quality. **Economode** can be selected only from the custom options (not from the slider).

There is also two supplementary custom options that may have an effect on print quality: **Maximum Detail** and **More Passes**. See [High-quality printing on page 79](#).

 **NOTE:** In the Windows driver dialog, the rendering resolution for your job is displayed in the Custom Print Quality Options dialog box (select **Custom options** and then **Settings**).

You can select print-quality options in the following ways:

- **In the Windows driver dialog:** go to the **Paper/Quality** tab and look at the Print Quality section. If you select **Standard Options**, you will see a simple slider with which you can select speed or quality. If you select **Custom Options**, you will see the more specific options described above.
- **In the Mac OS X Print dialog:** go to the **Paper/Quality** panel and look at the Quality Options section. If you select **Standard** quality options, you will see a simple slider with which you can select speed or quality. If you select **Custom** quality options, you will see the more specific options described above.
- **On the Embedded Web Server's Submit Job page:** select **Basic settings > Print quality**. If you then select **Standard options**, you can choose between **Speed** and **Quality**. If you select **Custom options**, you will see the more specific options described above.
- **Using the front panel:** press , then , then **Setup > Printing preferences > Print quality**.

 **NOTE:** If the print quality is set from your computer, it overrides the print-quality setting in the front panel.

 **NOTE:** You cannot change the print quality of pages that the printer is already receiving or has already received (even if they have not started to print yet).



Select paper size

The paper size can be specified in the following ways.

 **NOTE:** The paper size specified here should be the paper size in which the document was created. It is possible to rescale the document to a different size for printing. See [Rescale a print on page 77](#).

- **In the Windows driver dialog:** select the **Paper/Quality** tab, then select your paper size from the **Document Size** list.
- **In the Mac OS X Print dialog:** select your printer, then select your paper size from the **Paper Size** list.

 **NOTE:** If your application offers no **Page Setup** dialog, please use the **Print** dialog.

- **On the Embedded Web Server's Submit Job page:** select **Advanced settings > Paper > Page size > Standard**.
- **Using the front panel:** press , then , then **Setup > Printing preferences > Paper options > Paper size**.

 **NOTE:** If the paper size is set from your computer, it overrides the paper size setting in the front panel.

Custom paper sizes

If you want to choose a paper size that is not included in the list of standard paper sizes, there are various different ways to specify it.

Use the Windows printer driver

1. Select the **Paper/Quality** tab.
2. Press the **Custom** button.

3. Enter the name and dimensions of your new paper size.
4. Press **OK**. The new paper size is automatically selected.

A custom paper size created in this way has the following characteristics:

- The paper size is permanent. It will not disappear if the driver is closed or the computer is turned off.
- The paper size is local to the printer queue. It will not be seen from other printer queues in the same computer.
- In Domain server networks, the paper size is local to the computer. It will not be seen from other computers sharing the printer queue.
- In Workgroup networks, the paper size will be shared among all the computers sharing the printer queue.
- If the printer queue is deleted, the paper size is deleted with it.

Use Windows forms

1. From the Start menu, or from the Control Panel, select **Printers and Faxes**.
2. From the **File** menu, select **Server Properties**.
3. In the **Forms** tab, check the **Create a new form** box.
4. Enter the name and dimensions of your new paper size. Leave the margins as 0.00.
5. Press the **Save Form** button.
6. Go to the printer driver, and select the **Paper/Quality** tab.
7. Select **More...** from the drop-down list of paper sizes.
8. Select your new paper size from the group of Custom sizes.

A custom paper size created in this way has the following characteristics:

- The paper size is permanent. It will not disappear if the driver is closed or the computer is turned off.
- Restricted users cannot create paper forms. The “manage documents” role in the Windows Active Directory is the minimum required.
- The paper size is local to the computer. It will be seen in all the printer queues that have been created on the computer and that support paper of that size.
- If a printer queue is shared, this paper size will appear in all the client computers.
- If a printer queue is shared from another computer, this paper size will **not** appear on the driver’s document size list. A Windows form in a shared queue needs to be created in the server.
- If the printer queue is deleted, the paper size is not deleted.

Use the Mac OS X printer driver

1. Go to the **Page Setup** dialog.



NOTE: If your application offers no **Page Setup** dialog, please use the **Print** dialog.

2. Select **Paper Size > Manage Custom Sizes**.

Use the Embedded Web Server

1. Go to the **Submit Job** page.
2. Select **Advanced settings > Paper > Page size > Custom**.

Select margins options

By default, the printer leaves a 5 mm margin between the edges of your image and the edges of the paper (increased to 17 mm at the foot of cut-sheet paper). However, you can change this behavior in several ways.

- **In the Windows driver dialog:** select the **Paper/Quality** tab and then the **Margins/Layout** button.
- **In the Mac OS X Print dialog:** select the **Margins/Layout** panel.
- **On the Embedded Web Server's Submit Job page:** select **Advanced settings > Paper > Layout/Margins**.

You will then see at least some of the following options.



NOTE: Under Mac OS X, the available margins options depend on the paper size selected. For instance, for borderless printing you must select a paper size name that includes the words “no margins”.

- **Standard.** Your image will be printed on a page of the size you have selected, with a narrow margin between the edges of the image and the edges of the paper. The image should be small enough to fit between the margins.
- **Oversize.** Your image will be printed on a page slightly larger than the size you have selected. If you cut off the margins, you will be left with a page of the size you selected, with no margins remaining between your image and the edges of the paper.
- **Clip Contents By Margins.** Your image will be printed on a page of the size you have selected, with a narrow margin between the edges of the image and the edges of the paper. In this case, if the image is the same size as the page, the printer assumes that the extreme edges of the image are either white or unimportant, and do not need to be printed. This may be useful when your image already contains a border.
- **Borderless.** Your image will be printed on a page of the size you have selected, with no margins. The image is slightly enlarged to ensure that no margin is left between the edges of the image and the edges of the paper. If you select **Automatically by Printer**, this enlargement is done automatically. If you select **Manually in Application**, you must select a custom page size slightly larger than the page on which you intend to print. See also [Print with no margins on page 80](#).

Print on loaded paper

To print a job on whichever paper is loaded in the printer:

- **In the Windows driver dialog:** select the Paper/Quality tab, then select **Use printer settings** in the Paper Type drop-down list.
- **In the Mac OS X Print dialog:** select the Paper/Quality panel, then select **Any** in the Paper Type drop-down list.





NOTE: These are the default Paper Type selections.

Rescale a print

You can send an image to the printer at a certain size but tell the printer to rescale it to a different size (normally larger). This may be useful:

- If your software does not support large formats
- If your file is too large for the printer's memory—in this case, you can reduce the paper size in your software and then scale it up again using the front-panel option

You can rescale an image in the following ways:

- **In the Windows driver dialog:** go to the **Layout/Output** tab and look at the Resizing Options section.
 - The **Print document on** option adjusts the image size to the paper size you have selected. For example, if you have selected ISO A2 as the paper size and you print an A3-sized image, it is enlarged to fit the A2 paper. If the ISO A4 paper size is selected, the printer reduces a larger image to fit the A4 size.
 - The **% of actual size** option enlarges the printable area of the original paper size (the page minus the margins) by the percentage indicated, then adds the margins to create the output paper size.
- **In the Mac OS X Print dialog (non-PostScript printers):** select the **Paper Handling** panel, then **Scale to fit paper size**, and select the paper size to which you want to scale the image. If you want to increase the size of the image, make sure that the **Scale down only** box is unchecked.
- **In the Mac OS X Print dialog (PostScript printers):** select the **Finishing** panel, then **Print document on**, and select the paper size to which you want to scale the image. For example, if you have selected ISO A2 as the paper size and you print an A3-sized image, it is enlarged to fit the A2 paper. If the ISO A4 paper size is selected, the printer reduces a larger image to fit the A4 size.
- **On the Embedded Web Server's Submit Job page:** select **Advanced settings > Resizing**.
 - The **Standard** and **Custom** options adjust the image size to the standard or custom paper size you have selected. For example, if you have selected ISO A2 as the paper size and you print an A4-size image, it is enlarged to fit the A2 paper. If the ISO A3 paper size is selected, the printer reduces a larger image to fit the A3 size.
 - The **% of actual size** option enlarges the printable area of the original paper size (the page minus the margins) by the percentage indicated, then adds the margins to create the output paper size.
- **Using the front panel:** press , then , then **Setup > Printing preferences > Paper options > Resize**.

If you are printing to a single sheet, you must ensure that the image can actually fit onto the sheet, otherwise the image will be clipped.



Change the treatment of overlapping lines



NOTE: This topic applies only when printing an HP-GL/2 job.

The merge option controls the overlapping lines in an image. There are two settings:

- Off: where the lines cross, only the color of the top line is printed. This is the default setting.
- On: where the lines cross, the colors of the two lines merge.

To turn merge on, go to the front panel and press , then , then **Setup > Printing preferences > HP-GL/2 options > Merge**. You can set the merge option from your software in some applications. Settings in your software override the front-panel settings.



Preview a print

Previewing a print on the screen allows you to check the layout of the print before printing, which may help you to avoid wasting paper and ink on a bad print.

- To preview a print under Windows, you have the following options:
 - Use your application's print preview option.
 - Check the **Show preview before printing** option, which you can find in the driver's **Paper/Quality** tab and **Layout/Output** tab. The preview may be provided in different ways, depending on your printer and printer driver.
- To preview a print under Mac OS X, you have the following options:
 - Use your application's print preview option.
 - Open the **PDF** menu at the bottom left of your application's **Printing** panel. Select the **HP Print Preview** option, which opens the HP Print Preview application to display the final appearance of your printed image. Printing features, such as the ability to change paper size, paper type, and print quality, or rotate the image, can be changed on the fly.
- To preview a print using the Embedded Web Server, select **Basic settings > Hold for preview**.



Print a draft

You can specify fast draft-quality printing in the following ways:

- **In the Windows driver dialog:** go to the **Paper/Quality** tab and look at the Print Quality section. Move the print-quality slider to the extreme left ('Speed').
- **In the Mac OS X Print dialog:** go to the **Paper/Quality** panel and move the print-quality slider to the extreme left ('Speed').
- **On the Embedded Web Server's Submit Job page:** select **Basic settings > Print quality > Standard options > Speed**.
- **Using the front panel:** press , then , then **Setup > Printing preferences > Print quality > Quality level > Fast**.

You can specify even faster draft-quality printing by using Economode, as follows. This is intended mainly for documents containing only text and line drawings.



- **In the Windows driver dialog:** go to the **Paper/Quality** tab and look at the Print Quality section. Select **Custom Options**, then set the quality level to **Fast** and check the **Economode** box.
- **In the Mac OS X Print dialog:** go to the **Paper/Quality** panel and set the quality options to **Custom**, then set quality to **Fast** and check the **Economode** box.

- **On the Embedded Web Server's Submit Job page:** select **Basic settings > Print quality > Custom**. Set **Quality level** to **Fast**, and **Economode** to **On**.
- **Using the front panel:** press , then , then **Setup > Printing preferences > Print quality > Economode**.

 **NOTE:** If the print quality is set from your computer, it overrides the print-quality setting in the front panel.

High-quality printing

You can specify high-quality printing in the following ways:



- **In the Windows driver dialog:** go to the **Paper/Quality** tab and look at the Print Quality section. Move the print-quality slider to the extreme right ('Quality').
- **In the Mac OS X Print dialog:** go to the **Paper/Quality** panel and move the print-quality slider to the extreme right ('Quality').
- **On the Embedded Web Server's Submit Job page:** select **Basic settings > Print quality > Standard options > Quality**.
- **Using the front panel:** press , then , then **Setup > Printing preferences > Print quality > Quality level > Best**.

 **NOTE:** If the print quality is set from your computer, it overrides the print-quality setting in the front panel.

 **TIP:** For the highest-quality printing on photo paper, see [Manual printing with the stacker open on page 61](#).

If you have a high-resolution image

If your image has a resolution greater than the rendering resolution (which you can see in the Custom Print Quality Options box under Windows), print sharpness may be improved by selecting the **Maximum Detail** option. This option is available only if you are printing on photo paper and you have selected **Best** print quality.

- **In the driver dialog (Mac OS X Print dialog):** select Custom instead of Standard print-quality options, then check the **Maximum Detail** box.
- **On the Embedded Web Server's Submit Job page:** select **Basic settings > Print quality > Custom**. Set **Quality level** to **Best**, and **Maximum detail** to **On**.
- **Using the front panel:** press , then , then **Setup > Printing preferences > Print quality > Maximum detail**.

 **NOTE:** The **Maximum Detail** option results in slower printing with photo papers, but it does not increase the amount of ink used.

If you have printhead problems

If your printheads have an excessive number of clogged nozzles (which may cause banding or white streaks on your prints), print quality can be improved by selecting the **More Passes** option.

- **In the driver dialog (Mac OS X Print dialog):** select custom instead of standard print-quality options, then check the **More Passes** box.
- **On the Embedded Web Server's Submit Job page:** select **Basic settings > Print quality > Custom**. Set **Quality level** to **Best**, and **More passes** to **Yes**.

 **NOTE:** The **More Passes** option results in slower printing, but it does not increase the amount of ink used.

 **TIP:** Instead of using this option, consider using the Image Diagnostics Print to identify the printhead or printheads that are causing the problem, and then clean or replace them. See [The Image Diagnostics Print on page 194](#).

Print in gray shades

You can convert all colors in your image to shades of gray: see [Printing in grayscale on page 108](#).

Print with no margins

Printing with no margins (to the edges of the paper) is known as borderless printing. This can be done only on rolls of photo paper.

In order to be sure of leaving no margins, the printer prints slightly past the edges of the paper. Any ink deposited outside the paper is absorbed by the sponge situated in the platen.

You can request printing with no margins in the following ways:

- **In the Windows driver dialog:** select the **Paper/Quality** tab and press the **Margins/Layout** button. Then select **Borderless**.
- **In the Mac OS X Page Setup dialog:** select a paper size name that includes the words “no margins”. Then, in the **Print** dialog, select **Margins/Layout > Borderless**.

 **NOTE:** If your application offers no **Page Setup** dialog, please use the **Print** dialog.

- **In the Mac OS X PostScript Page Setup dialog:** select a paper size name that includes the words “no margins”. Then, in the **Print** dialog, select **Margins/Layout > Borderless**.

 **NOTE:** If your application offers no **Page Setup** dialog, please use the **Print** dialog.

- **On the Embedded Web Server's Submit Job page:** select **Advanced settings > Paper > Layout/Margins > Borderless**.

When you select **Borderless**, you must also select one of the following Image Enlargement options:

- **Automatically by printer** means that the printer automatically enlarges your image slightly (normally by a few millimeters in each direction) in order to print over the edges of the paper.
- **Manually in application** means that you must enlarge the image yourself in your application, and select a custom paper size that is slightly larger than the actual paper size.

 **NOTE:** If the first print job after loading paper is a borderless job, the printer may trim the leading edge of the paper before printing.

At the end of a borderless print, the printer normally cuts the print slightly inside the image area to ensure that the print is borderless. It then cuts the paper again so that no residual part of the image is included in the next print. However, if the job is cancelled, or if there is white space at the bottom of the image, only a single cut is made.

Print with crop lines

Crop lines indicate where the paper should be cut to reduce it to your selected page size. You can print crop lines with individual jobs in the following ways:

- **In the Windows driver dialog:** select the **Layout/Output** tab, then **Crop lines**.
- **In the Mac OS X Print dialog:** select the **Finishing** panel, then **Crop lines**.
- **On the Embedded Web Server's Submit Job page:** select **Advanced settings > Roll options > Enable crop lines > Yes**.

Alternatively, you can choose to print crop lines with all jobs by default:

- **In the Embedded Web Server:** select **Setup > Printer settings > Job management > Use crop lines when printing > On**.
- **Using the front panel:** press , then , then **Setup > Printing preferences > Paper options > Enable crop lines > On**.

To print crop lines with nested jobs (see [Nest jobs to save roll paper on page 81](#)), you must select a different option:

- **In the Embedded Web Server:** select **Setup > Printer settings > Job management > Use crop lines when nest is enabled > On**.
- **Using the front panel:** press , then , then **Setup > Job management > Nest options > Enable crop lines > On**.

Use paper economically

Here are some recommendations for making economical use of paper:

- If you are printing relatively small images or document pages, you can use nesting to print them side by side instead of one after another. See [Nest jobs to save roll paper on page 81](#).
- You may be able to save some roll paper by using the following options:
 - **In the Windows driver dialog:** select the **Layout/Output** tab and then **Remove blank areas** and/or **Rotate by 90 degrees** or **Autorotate**.
 - **In the Mac OS X Print dialog (non-PostScript printers):** select the **Finishing** panel, then **Remove Blank Areas**.
 - **In the Mac OS X PostScript Print dialog (PostScript printers):** select the **Finishing** panel, then **Remove Blank Areas** and/or **Rotate by 90 degrees**.
 - **On the Embedded Web Server's Submit Job page:** select **Advanced settings > Roll options > Remove top/bottom blank areas** and/or **Rotate**.
- If you check the print preview on your computer before printing, you can sometimes avoid wasting paper on prints containing obvious mistakes. See [Preview a print on page 78](#).

Nest jobs to save roll paper

Nesting means automatically printing images or document pages side by side on the paper, rather than one after the other. This is done to avoid wasting paper.

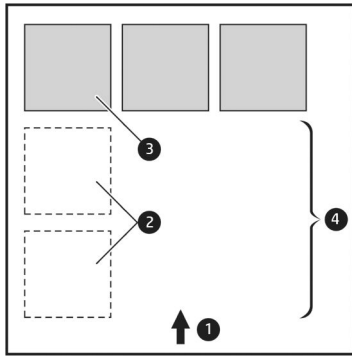

1. Direction of paper flow
2. Nesting off
3. Nesting on
4. Paper saved by nesting

When does the printer try to nest pages?

When both of the following are true:

- The printer is loaded with roll paper, not sheet paper.
- The printer's **Nest** option is turned on. See [Turn nesting on and off on page 29](#).

What pages can be nested?

All pages can be nested, unless they are so large that two of them cannot fit side by side on the roll, or unless there are too many of them to fit into the remaining length of the roll. A single group of nested pages cannot be split between two rolls.



Which pages qualify for nesting?

In order to be in the same nest, the individual pages must be compatible in all of the following ways:

- All pages must have the same print quality setting (**Economode**, **Fast**, **Normal** or **Best**).
- The **Maximum Detail** setting must be the same on all pages.
- The **Layout/Margins** setting must be the same for all pages.
- The **Mirror Image** setting must be the same for all pages.
- The **Rendering Intent** must be the same for all pages.
- The **Cutter** setting must be the same for all pages.
- The color adjustment settings must be the same for all pages. See [Color adjustment options on page 107](#).
- Pages must be all color, or all grayscale: not some in color and some in grayscale.
- All pages must be in one or other of the following two groups (the two groups cannot be mixed in the same nest):

- HP-GL/2, RTL, TIFF, JPEG
- PostScript, PDF
- JPEG and TIFF pages with resolutions greater than 300 dpi may not nest with other pages in some cases.

How long does the printer wait for another file?

So that the printer can make the best nest possible, it waits after a file has been received to check whether a subsequent page will nest with it or with pages already in the queue. This waiting period is the nest wait time; the factory default nest wait time is 2 minutes. This means that the printer waits for up to 2 minutes after the last file is received before printing the final nest. You can change this waiting time from the printer's front panel: press , then , then **Setup > Job management > Nest options > Wait time**. The available range is 1 to 99 minutes.

While the printer is waiting for nesting to time out, it displays the remaining time on the front panel.

Use ink economically

Here are some recommendations for making economical use of ink.

- For draft prints, use plain paper and move the print-quality slider to the left end of the scale ('Speed'). For further economy, select custom print quality options, then select **Fast** and **Economode**.
- Clean the printhead only when needed. Cleaning the printhead can be useful, but it uses a small amount of ink.
- Leave the printer permanently turned on so that it can maintain the printhead in good condition automatically. This regular printhead maintenance uses a small amount of ink. However, if it is not done, the printer may need to use much more ink later to restore the health of the printhead.
- Wide prints make more efficient use of ink than narrow prints, because printhead maintenance uses some ink, and its frequency is related to the number of passes made by the printhead. Therefore, nesting jobs can save ink as well as saving paper (see [Nest jobs to save roll paper on page 81](#)).

Roll protection

If you choose to protect a roll, jobs will be printed on it only if the job explicitly specifies the roll number or the paper type loaded on the roll. This may be useful, for example, in the following cases.

- To stop people from accidentally printing unimportant jobs on expensive paper.
- To avoid printing on a particular roll when printing from AutoCAD without interacting with the HP printer driver.

To protect a roll, go to the front panel and press , then , then **Setup > Printing preferences > Paper options > Roll protection**.

 **NOTE:** If you protect a roll, then later unload the current roll and load a new one, the new roll remains protected. You are protecting the roll number, not one specific roll of paper. That roll number will remain protected until you cancel the protection.

 **TIP:** If you print without specifying a roll number or paper type, you will not be able to print on any protected roll.

Unattended printing/overnight printing



The printer is well suited to long, unattended print jobs, having multiple rolls plus robust and consistent image quality.

Here are some recommendations to help you deal with a long queue of printing jobs.

- Empty the stacker.
- If feasible, use brand-new long rolls of paper.
- If you want to print on partly-used rolls, you can check the paper type and the remaining length in the Embedded Web Server or in the front panel, to confirm that you have enough paper to print all your jobs.



NOTE: Information on the remaining length is available only if you told the printer the length of the roll when you loaded it, or if the printer read the length of the roll from the barcode printed on it.

- Load two rolls of paper suitable for your jobs. If the printer finishes one roll, it will automatically switch to the other.
- Check that you have paper wide enough to print all of your jobs. Any jobs that are too wide may be put “on hold for paper” if the paper mismatch action is set to **Put job on hold** (see [Paper mismatch action on page 28](#)).
- Check the ink levels remaining in your ink cartridges.
- When you have submitted your print jobs, you can use the Embedded Web Server from a remote location to monitor their status.
- Drying time should be set to **Optimal**.
- Press , then , then **Setup > Printing preferences > Paper options > Roll switching options > Minimize roll changes** or **Use roll with less paper**.





We recommend the following settings, depending on the paper type and what kind of prints you are making.

Table 8-1 Recommended settings for unattended printing

Print type	Print mode	MaxDetail	Drying time	Paper types
Lines	Normal	Off	Optimal	Coated, Bond, Heavyweight Coated, Photo
Lines and fills	Normal	On	Optimal	Coated, Bond, Heavyweight Coated, Photo
Maps	Best	On	Optimal	Coated, Heavyweight Coated, Photo
Renderings, photographs	Best	On	Optimal	Coated, Heavyweight Coated, Photo

Print from iOS with AirPrint

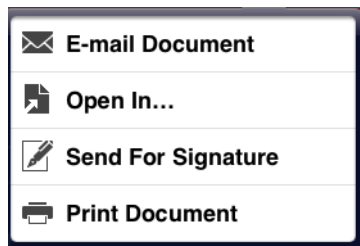

You can print using AirPrint without needing a printer driver, bearing in mind the following points.

- Ensure that Airprint is enabled: go to the printer's front panel and press , then , then **Setup > Connectivity > AirPrint connectivity > AirPrint**.
- Your AirPrint device must be in the same segment of the same local network as the printer. When using Wi-Fi, the Wi-Fi network must be bridged to the wired network used by the printer (as is the case with most home or small-office routers).
- To identify the right printer from your AirPrint device, go to the printer's front panel, press , then , and make a note of the Bonjour/AirPrint name.
- Many iPhone apps may not be able to print pages larger than A4 or US Letter size. Please check with the app developer.
- If you cannot print from the app you are using, try printing from another app.

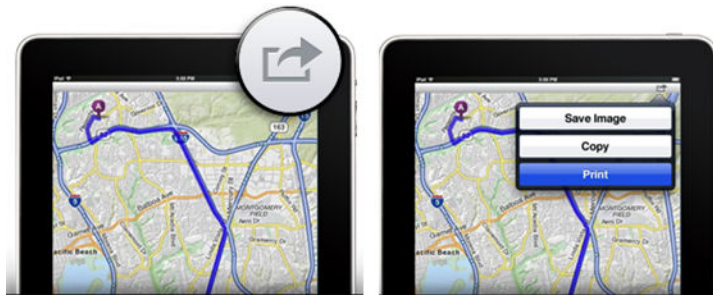

- To print, press the arrow and then **Print**. Choose your printer's name from the list that appears.



- If you need more information, go to the printer's front panel, and press , then , then **Setup > Connectivity > AirPrint connectivity > Help**.

Alternatively, visit <http://www.hp.com/go/airprint>.

9 Scanning

Paper types suitable for scanning

The scanner does not support the full range of paper types that may be used by the printer.

The following paper types are supported by the scanner.

- **White paper** to scan any matte original printed with inkjet technology. Choose this option to scan, for instance, anything printed with this printer on any of these paper types: HP Universal Inkjet Bond Paper, HP Coated Paper, HP Heavyweight Coated Paper, plain paper.
- **Photo paper** to scan glossy and satin originals. Inkjet, offset and traditional photo technologies are supported by this option. Choose this option to scan, for instance, any photo or other image printed on any of these paper types: HP Universal High Gloss Photo Paper, HP Premium Instant Dry Gloss/Satin Photo Paper. However, for some specific photo originals, this option may not give completely accurate results, in which case you could try **White paper** instead.

 **CAUTION:** Photo and glossy papers may be scratched while passing through the scanner.

- **Old/recycled paper** to scan matte originals printed on recycled paper or very old originals, the background of which is no longer white. Choose this option to scan, for instance, anything printed on this printer using HP Recycled Bond Paper, or any old print on plain paper that has become yellowish over the years.
- **Translucent paper** to scan semi-transparent tracing papers (> 65 g/m²), including HP Natural Tracing Paper, HP Vellum and HP Translucent Bond.
- **Blueprints** for scanning blueprint originals with optimum results, in grayscale only. This option greatly enhances the contrast of the resulting image.

For best results, you should select the correct paper type in the scan settings before scanning.

The following paper types are not supported by the scanner.

- Film
- Backlit material
- Cling material
- Translucent paper (< 65 g/m²)

Scan to file

1. Load the sheet with the printed side facing upwards (you can also load the sheet before step 1, if you prefer). Align the center of the sheet approximately with the center of the scanner. Use the standard size markings to help you.



 **NOTE:** The maximum length of paper that the scanner can scan depends on the paper width and the scan resolution. An alert is displayed if the maximum length is exceeded.

 **NOTE:** Scanned images may be saved to PDF files with the T25x0 PS only.

2. Push the sheet into the insertion slot until you feel it contact the rollers. The scanner will automatically grab the sheet and move it into position for scanning. If you feel that the sheet has loaded badly and you want to try again, you can pull it out manually.

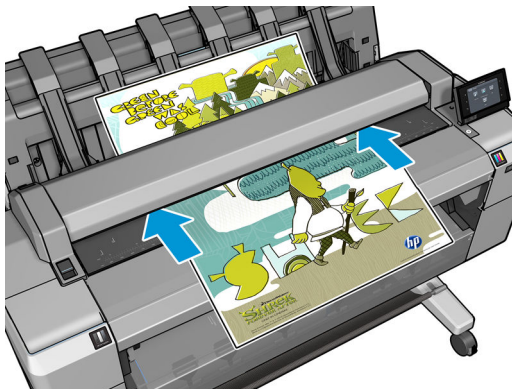

3. At the front panel, go to the home screen and press  , then select where you would like to store the scanned image.

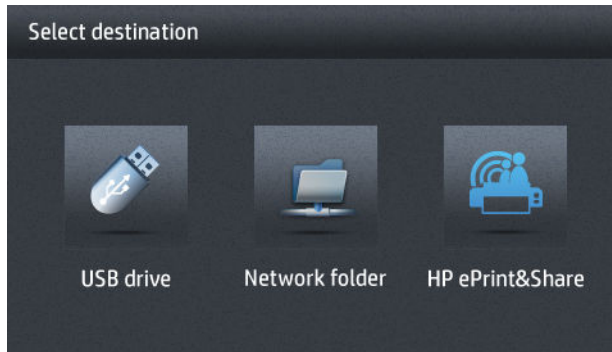





- In a USB flash drive

 **NOTE:** The use of USB flash drives with your printer may be disabled in the Embedded Web Server (**Setup > Security > Disable USB drives**).



- In a network folder (a folder on a computer that is accessible through the network)



 **NOTE:** The network folder option will not work unless the network folder has been correctly set up and identified in the Embedded Web Server or HP Utility: see [Configure a scan-to-network or scan-to-FTP folder on page 23](#).

 **TIP:** To check the currently-configured network folder, go to the front panel and press , then .

 **NOTE:** If the scanner is later unable to store your file in the chosen destination (USB flash drive or network folder), you are given the opportunity to change your mind and use the other alternative.



4. Some of the default scan settings are displayed. Press **Settings** to see the complete list of settings, and check in particular that the **Original type** setting corresponds to the paper type that you intend to scan.
 - **Format** allows you to specify the format of the file in which the scanned image will be saved: TIFF, JPEG or (with the T2500 PS only) PDF.
 - **Compression** allows you to specify the level of compression: maximum, high (the default level), medium, or low. This option is available if the format is JPEG or PDF.
 - **Resolution** allows you to specify the scan resolution: Standard (200 dpi), High (300 dpi), or Max (600 dpi).
 - **Color** allows you to choose color, grayscale or black and white scanning.
 - **Content type** allows you to optimize the scan for a line drawing, a photographic image, or a mixed image.
 - **Original type** allows you to specify the paper type on which the original image has been printed. To optimize scan quality, ensure that this setting is correct.
 - **Background removal** allows you to remove unwanted background color. You can specify the strength of this setting, from 0 to 10.
 - **Blueprints invert** allows you to generate a scanned image with a light background. It is useful when the original you intend to scan is a blueprint with a dark background. This option is available only if the **Original type** is set to **Blueprints**.

 **NOTE:** If you change the settings in this way, the changed settings apply to the current job but are not saved permanently. You can change most of the default settings from the main menu: press , then **Scan preferences**.

5. When you are satisfied with the scan settings, press anywhere on the screen to return to the previous page, then press **Start**.
6. Once the original has been scanned, you can (if you like) check the file size and change the automatically-generated filename of the scanned image.
7. If you are scanning to a USB flash drive, wait until the scanned image has been saved in a file, then press  on the front panel and press **Eject**. Remove the USB flash drive when prompted by the front panel.
8. Press  to eject the scanned sheet from the scanner; be ready to pick it up from the rear.
9. After scanning, you can choose to scan again or go to the job queue.

 **TIP:** All scan jobs are saved in the scan queue, where they can be accessed by any user. If your job is private, you may wish to delete it from the queue after recovering the image file.

TIP: If you scan an image to a file and then decide to print it one or more times, you can change the print settings every time. You can also save it to another location.

 **NOTE:** By default, if the original is skewed in the scanner (not loaded straight), the scanner will try to correct the skew automatically. To turn off this automatic correction, press , then , then **Scan preferences > De-skew > Off**.

10 Copying

Before starting to copy, see [Paper types suitable for scanning on page 86](#).

1. Load the sheet with the printed side facing upwards (you can also load the sheet before step 1, if you prefer). Align the center of the sheet approximately with the center of the scanner. Use the standard size markings to help you.

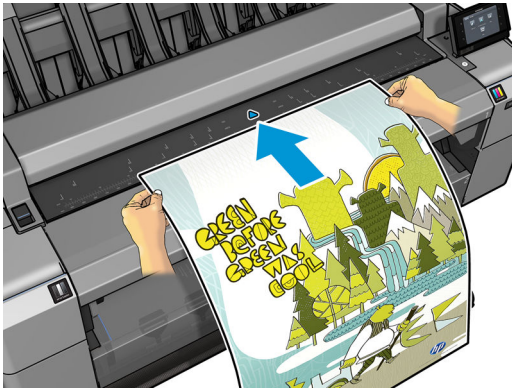

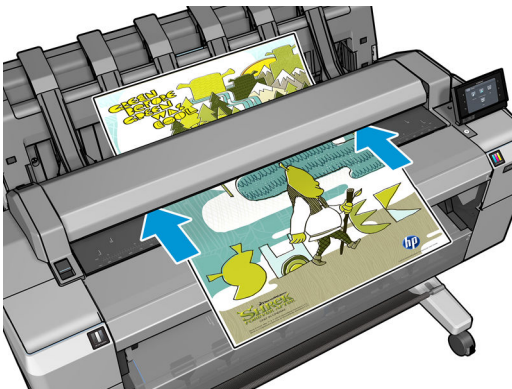

 **NOTE:** The maximum length of paper that the scanner can scan depends on the paper width and the scan resolution. An alert is displayed if the maximum length is exceeded.

2. Push the sheet into the insertion slot until you feel it contact the rollers. The scanner will automatically grab the sheet and move it into position for scanning. If you feel that the sheet has loaded badly and you want to try again, you can pull it out manually.



3. At the front panel, go to the home screen and press  .
4. Some of the default copy settings are displayed. Press **Settings** to see the complete list of settings, and check in particular that the **Paper type** setting corresponds to the paper type that you intend to scan.



- **Size** allows you to resize the print in two different ways: to a percentage of its original size, or to fit a particular paper size. The default is 100% (its original size).
- **Copy quality** allows you to set the print quality to **Best**, **Normal** or **Fast**.
- **Copy color** allows you to choose color or grayscale printing.
- **Roll** allows you to specify printing on roll 1 or roll 2, or you can choose **Save paper**, which automatically chooses the narrowest roll on which the print will fit.
- **Job output** allows you to send the print to stacker or basket.
- **Content type** allows you to optimize the scan for a line drawing, a photographic image, or a mixed image.
- **Original type** allows you to specify the paper type on which the original image has been printed. To optimize scan quality, ensure that this setting is correct.

 **NOTE:** If you change the settings in this way, the changed settings apply to the current job but are not saved permanently. You can change the default settings from the main menu: press , then , then **Copy preferences**.

5. When you are satisfied with the copy settings, press anywhere on the screen to return to the previous page, then press **Start**.
6. If two rolls are loaded, you can choose to print on either roll, or you can let the printer choose automatically.

 **NOTE:** The printer will automatically rotate the image by 90° if it can save paper by doing so.

7. When the scan is complete, press  to eject the scanned sheet from the scanner; be ready to pick it up.
8. While the scanned image is being printed, you can perform some other operation: you don't need to wait for the end of the print.
9. After printing, you can choose to make another copy or go to the job queue. If you make another copy immediately without returning to the home screen, the temporary settings used for the previous copy are used again.

 **NOTE:** By default, if the original is skewed in the scanner (not loaded straight), the scanner will try to correct the skew automatically. To turn off this automatic correction, press , then , then **Scan preferences > De-skew > Off**.

11 Mobile printing

- [Introduction](#)
- [Print from mobile devices](#)
- [Print from Apple iOS](#)
- [Print from Android](#)
- [Print by email \(HP ePrint\)](#)
- [Mobile Printing](#)

Introduction

You can print to your printer from many mobile devices and from almost any location. There are two main methods of Mobile Printing:

- Direct printing by connection to the same network
- Printing by e-mail

Print from mobile devices

You can print directly from the operating system of your mobile device, if your mobile device and printer are connected to the same network.

For more information, see <http://www.hp.com/go/designjetmobility>.

Print from Apple iOS

iOS printing is enabled through Airprint. You must have iOS 7.0 or later.

1. Open the document or photo you want to print, and press the **Share** button.
2. Swipe the screen to reveal the Print button, and press it.
3. Check the print settings, then press **Print**.

Print from Android

For Android printing, install and enable the HP Print Service App from Google Play (<https://play.google.com/store/apps/details?id=com.hp.android.printservice&hl=en>), if it is not already installed in your device. You must have Android KitKat 4.4 or later.

1. Open the document or photo you want to print, and press the menu icon, and select **Print**.
2. Choose your printer from the list.
3. Check the print settings, then press **Print**.

Print by email (HP ePrint)

After you have enabled Web Services in the printer (see [Set up web services on page 21](#)), you can print to that printer by email. Just check the Web Services menu or the ePrint menu for the email address of your printer, then send the file you want to print to that email address as an attachment.

- The attached files to be printed must be in PDF, JPEG, or TIFF formats.
- The maximum file size is 10 MB, but your email server may have a lower limit.
- Files are printed in the original document size (at 100% scale), in normal quality, in color, and normally in portrait orientation (some printers may offer autorotation).

For more information, see <https://www.hpconnected.com>.

Mobile Printing

Print from in-OS (internal Operating Systems)

iPhone, iPad

Printing with AirPrint™ is simple, all you have to do is make sure your device and printer are operating on the same network and follow the steps below.

1. Choose your content. Open the document or photo you want to print, tap the share button.
2. Select print icon. Swipe screen to reveal print button on bottom now, then tap the print icon.
3. Print. Confirm the correct printer setting are selected. Tap “print” and collect your documents.

All Android

Printing with Android device is simple and depending on your model, printing may already be preloaded on your device. If it is not, all you need to do is download the HP Print Service Plugin from the Google play store to get started.

1. Choose your content. Open the document or photo you want to print, tap the menu icon and select “Print”.
2. Choose your printer. Select from the list of printers that appears.
3. Print! Confirm the correct printer and print setting are selected. Tap “Print” and collect your documents.

12 Job queue management

- [The job queue in the front panel](#)
- [The job queue in the Embedded Web Server or HP Utility](#)

The job queue in the front panel

To see the job queue on the front panel, press  on the home screen. You can choose **Print & Copy Jobs** or **Scan Jobs** from the tabs at the top of the screen.

Job queue page

The job queue page shows all jobs that are available in whichever job queue you have selected. The print & copy queue includes jobs that are being received, parsed, rendered, printed, and already printed. The scan queue includes jobs that are being scanned and jobs that have been scanned.

Each line shows the name of the job and its status. Scan and copy jobs are assigned automatically-generated names, but you can change them if you like. For more information on a particular job, including a preview of the job, press the line showing the job.

Jobs that cannot be completed for any reason appear at the top of the queue.

Job preview

The printer generates a JPEG file for each incoming job, which can be displayed as a preview of the job. Job preview is available once the job is processed.

 **NOTE:** Do not try to preview a job with more than 64 pages, which may cause software problems.

To preview a job, first press the name of the job in the job queue. The front panel displays a page of information about the job, and the print preview.



 **NOTE:** Previews may be blocked by an administrator, in which case you will not be able to see them.

When the preview is displayed, you can press it to zoom in on it. Press it again to zoom out.

You can also press  to preview the previous job, or  to preview the next job.

Select when to print a job in the queue

 **NOTE:** The When To Start Printing options cannot be used with PostScript jobs.

You can select at what point you want to print a file you have in the queue. Press , then , then **Setup > Job management > When to start printing**.

There are three options you can select:

- When **After Processing** is selected, the printer waits until the whole page has been processed and then it starts to print. This is the slowest setting but ensures the best print quality in large or complex prints.
- When **Immediately** is selected, the printer prints the page as it is processed. This is the quickest setting, but the printer may stop halfway through a print to process data. This setting is not recommended for complex images with dense color.
- When **Optimized** is selected (this is the default setting), the printer calculates the best time to begin printing the page. It is usually the best compromise between the **After Processing** and **Immediately** settings.

Prioritize a job in the queue

You can select a job in the queue and make it the next one to be printed. After selecting the job, press **Move to front**.

If nesting is turned on, the prioritized job may still be nested with others. If you really want this job to be printed next, and not nested with others, first turn nesting off and then move it to the front of the queue as described above.

In the following cases, the **Move to front** button is not displayed:

- The job is already at the front of the queue.
- The job is on hold—in this case the **Force print** button is displayed instead.
- The job has finished—in this case the **Print** button is displayed instead.
- The job has some error condition.

Pause a job in the queue

If you select the job in the queue that is currently printing, you will see a **Pause** button, which you can press to pause printing. The **Pause** button then changes to a **Force print** button, which you can press to resume printing.

Reprint a job from the queue

To reprint an already-printed job, select the job from the queue, then select **Print**.

When reprinting a print job, you cannot change the print settings, because the job has already been rasterized.

Save a scanned job to another destination

From the scan queue, select the job, and **save to**. There you will be able to save the scanned job to another destination.

Delete a job from the queue

Under normal circumstances, there is no need to delete a job from the queue after printing it, as it will just fall off the end of the queue as more files are sent. However, if you have sent a file in error, and want to avoid printing it, you can simply select the job and then press **Delete**.



NOTE: If an administrator password has been set, it will be required.

In the same way, you can delete a job that has not been printed yet.

If the job is currently being printed (its status is **printing**), you can press **Cancel** and then **Delete**.

Delete all jobs

To delete all jobs in a queue, press the Delete icon at the top right of the job queue screen, and then press **Delete all Print & Copy jobs** or **Delete all Scan jobs**.



NOTE: If an administrator password has been set, it will be required.

Turn off the job queue

To turn off the job queue, press , then , then **Setup > Job management > Queue > Off**.

The job queue in the Embedded Web Server or HP Utility

The HP Utility provides a different way of accessing the Embedded Web Server's job management facilities, but the facilities are exactly the same whether you use the Embedded Web Server or the HP Utility.

To see the queue in the Embedded Web Server, select **Job Center** from the HP Utility.

Job queue page

By default, access to the job queue is open to all users. An administrator can set a password so that users are required to enter a password for:

- Seeing job previews
- Canceling or deleting jobs

The job queue page shows all jobs that are available in the print queue. The print queue includes jobs that are being received, parsed, rendered, printed and already printed.

The Embedded Web Server displays the following information for each print job:

- **Preview:** Click the icon to see the job preview. The job preview is available once the job is processed.
- **File name:** Click the file name to see the properties of the job.
- **Status:** Gives the current job status.
- **Pages:** Number of pages in the job.
- **Copies:** Number of copies printed.
- **Date:** Date and time the printer received the job.
- **User:** The user's name.

Jobs in the queue can be sorted by any of the information items (except Preview) by clicking on the title of the corresponding column. You can perform the following operations on one or all jobs in the queue:

- **Cancel:** Cancels the selected jobs. You are asked to confirm before the job is canceled. The job remains stored in the printer, but will not be printed unless you click **Reprint**.
- **Hold:** Holds the select jobs until you click **Continue** to print.
- **Continue:** All selected jobs, which are on hold, continue printing.
- **Reprint:** Prints more copies of a job. Type the number of copies (default 1, maximum 99) and click **Print**.
- **Move to front:** Sends all selected jobs to the top of the job queue.
- **Delete:** Deletes selected jobs from the job queue. You are asked to confirm before the job is deleted.



NOTE: The **Delete** operation can be disabled by an administrator.

- **Refresh:** Refreshes the page, ensuring the information is updated.



NOTE: The job queue page does not automatically update.

Job preview

The printer generates a JPEG file for each incoming job, which can be displayed as a preview of the job. Job preview is available once the job is processed.

 **NOTE:** Do not try to preview a job with more than 64 pages, which may cause software problems.

To reach the preview page, click the magnifying glass icon, which appears in the Preview column on the job queue page. The preview page shows the following job details along with a thumbnail preview of the job:

- **File name:** The file name of the job.
- **Loaded paper:** The type of paper loaded in the printer.
- **Job dimensions:** The dimensions of the job.

To see a larger preview of the job, click either the job thumbnail or the magnifying glass icon, which appears on the right-hand side of the printer image.

 **NOTE:** Browsers without the Adobe Flash plug-in show the job image as yellow shaded. Browsers that have the Adobe Flash plug-in version 7 and above show an enhanced preview of the job image inside the paper loaded in the printer.

Select when to print a job in the queue

 **NOTE:** The When To Start Printing options cannot be used with PostScript jobs.

You can select at what point you want to print a file you have in the queue. Select the **Setup** tab, then **Printer settings > Start printing**.

There are three options you can select:

- When **After Processing** is selected, the printer waits until the whole page has been processed and then it starts to print. This is the slowest setting but ensures the best print quality in large or complex prints.
- When **Immediately** is selected, the printer prints the page as it is processed. This is the quickest setting, but the printer may stop halfway through a print to process data. This setting is not recommended for complex images with dense color.
- When **Optimized** is selected (this is the default setting), the printer calculates the best time to begin printing the page. It is usually the best compromise between the **After Processing** and **Immediately** settings.

Prioritize a job in the queue

You can select any job in the queue and make it the next one to be printed. After selecting the job, click **Reprint**.

If nesting is turned on, the prioritized job may still be nested with others. If you really want this job to be printed next, and not nested with others, first turn nesting off and then move it to the front of the queue as described above.

Delete a job from the queue

Under normal circumstances, there is no need to delete a job from the queue after printing it, as it will just fall off the end of the queue as more files are sent. However, if you have sent a file in error, and want to avoid printing it, you can simply select the job and then select **Delete**.

In the same way, you can delete a job that has not been printed yet.

If the job is currently being printed (its status is **printing**), you can select **Cancel** and then **Delete**.

Reprint or copy a job in the queue

To reprint or make extra copies of any job in the queue, select the job in the Embedded Web Server and click the **Reprint** icon, then specify the number of copies you want. The job will be moved to the top of the queue. To make more than one print of a non-printed job in the queue from the front panel, select the job and choose **Copies**, then specify the number of copies required. This overrides any value set by your software.

 **NOTE:** If **Rotate** was **On** when you sent the file, every copy will be rotated.

 **NOTE:** You cannot use this method for PCL3GUI jobs. To reprint old jobs that are PCL3GUI, you may be able to use your operating system's printer spooler, if you have already set the spooler to save old jobs. This facility depends on your operating system.

 **NOTE:** When reprinting a print job, you cannot change the print settings, because the job has already been rasterized.

Job status messages

These are the possible job status messages, approximately in the order in which they may be seen:

- **Receiving:** The printer is receiving the job from the computer
- **Waiting to process:** The job has been received by the printer and is waiting to be rendered (for jobs submitted through the Embedded Web Server only)
- **Processing:** The printer is parsing and rendering the job
- **Preparing to print:** The printer is performing writing system checks before printing the job
- **Waiting to print:** The job is waiting for the print engine to become free to proceed with printing
- **Waiting for nest:** The printer is set up with Nesting=On and is waiting for other jobs in order to complete the nest and proceed with printing
- **On hold:** The job was sent with the **on hold for preview** option and is on hold

 **NOTE:** Do not send a job for preview with more than 64 pages, this may cause the driver software to crash.

 **NOTE:** If the printer hangs up while printing a job, and the queue facility is turned on, the partially printed job will appear in the queue as **on hold** when the printer is next turned on. When you resume the job, it will start printing at the page at which it was interrupted.

- **On hold for paper:** The job can't be printed because the right paper is not loaded in the printer. Load the required paper, see [Paper handling on page 51](#), and click **Continue** to resume the job
- **On hold for accounting:** The job can't be printed because the printer requires all jobs to have an account ID: enter the account ID and then click **Continue** to resume the job

 **TIP:** To set an account ID, see [Require account ID on page 33](#).

- **On hold for stacker:** The stacker is open, jammed, or full
- **On hold for manual mode:** You must go to the front panel to activate manual mode

- **Printing**
- **Drying**
- **Cutting paper**
- **Ejecting page**
- **Canceling:** The job is being canceled, but will remain in the printer job queue
- **Deleting:** The job is being deleted from the printer
- **Printed**
- **Canceled:** The job has been canceled by the printer
- **Canceled by user**
- **Empty job:** The job does not contain anything to print

Reactivate a job on hold

When the printer puts a job on hold you receive an alert, see [Alerts on page 235](#), which explains why the job is on hold. Follow the instructions on the screen to remove the hold and continue printing.

Turn off the job queue

To turn off the job queue, select the **Setup** tab, then **Printer settings > Job management > Queue** and select **Off**.

13 Color management

- [Introduction](#)
- [How colors are represented](#)
- [A summary of the color management process](#)
- [Color calibration](#)
- [Color management from printer drivers](#)
- [Color management from printer drivers \(PostScript printers\)](#)
- [Color management from the Embedded Web Server](#)
- [Color management from the front panel](#)
- [Color management and the scanner](#)

Introduction

Your printer has been engineered with advanced hardware and software features to ensure predictable and dependable results.

- Color calibration for consistent colors.
- One gray and two black inks provide neutral grays on all paper types.
- The Photo Black ink provides pure blacks when printing on photo papers.
- Color emulation of other HP DesignJet printers.

How colors are represented

All devices that display color use a color model to represent color in numerical terms. Most monitors use the RGB (Red-Green-Blue) color model, while most printers use the CMYK (Cyan-Magenta-Yellow-black) color model.

An image can be converted from one color model to another, but in general the conversion is not perfect. Your printer uses the RGB color model: the same color model that is used by your monitor.

This simplifies but does not completely solve the problem of matching colors. Each device represents colors a little differently from another device, even if they use the same color model. However, software can adjust the colors in an image according to the characteristics of the particular device, using a color profile of the device, in order to achieve correct colors.

A summary of the color management process

To get the accurate and consistent colors that you want, you should follow these steps for each paper type that you use.



1. Color-calibrate the paper type, for consistent colors. Calibration should be repeated every now and then (see [Color calibration on page 104](#)). In addition, you may wish to calibrate immediately before a particularly important print job for which color consistency is vital.
2. When printing, select the correct color preset for the paper type you are using.

Color calibration

Color calibration enables your printer to produce consistent colors with the particular printhead, inks, and paper type that you are using, and under your particular environmental conditions. After color calibration, you can expect to get similar prints from any two different printers situated in different geographical locations.

Some paper types cannot be calibrated. For all other paper types, calibration should be done in any of the following circumstances:

- Whenever the printhead is replaced
- Whenever a new paper type is introduced that has not yet been calibrated with the current printhead
- Whenever the environmental conditions (temperature and humidity) change significantly

You can check the color calibration status of the currently loaded paper from the front panel at any time: press , then , then **Image quality maintenance > Calibration status**. The status may be one of the following:

- **Recommended:** the paper has not been calibrated.



 **NOTE:** Whenever you update the printer's firmware, the color calibration status of all papers is reset to **Recommended**.

- **Obsolete:** the paper has been calibrated, but the calibration is now out of date because the printhead has been replaced, and should be repeated.
- **Done:** the paper has been calibrated, and the calibration is up to date.
- **Disabled:** this paper cannot be calibrated.

 **NOTE:** Color calibration cannot be performed on plain paper, nor on any kind of transparent material.

You can also check the color calibration status by using the HP Utility.

You can start color calibration in the following ways:

- From the HP DesignJet Utility for Windows: select **Color Center > Calibrate paper**, and choose the paper to be calibrated. If the Color Center is not available, try using the Print Quality Toolbox in the **Support** tab.
- From the HP Utility for Mac OS X: select **Paper Preset Management** from the HP Color Center group, choose the paper to be calibrated, press the  button and select **Calibrate Paper**.
- From the front panel: press , then , then **Image quality maintenance > Calibrate color**.

The calibration process is fully automatic and can be performed unattended after you have loaded paper of the type you wish to calibrate—which should be A4 or any larger size. If you have more than one roll loaded, the printer will ask which roll you want to use for the calibration.

The process takes about 3–5 minutes and consists of the following steps.

1. A calibration chart is printed, which contains patches of each ink used in your printer.

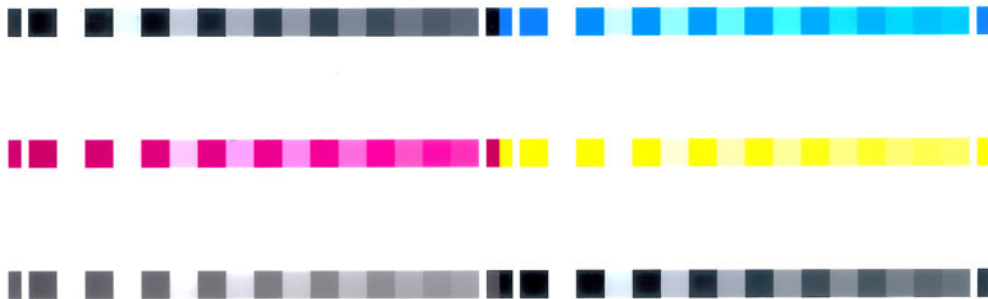

2. The chart is allowed to dry for a period of time that depends on the paper type, so that the colors have time to stabilize.

3. The chart is scanned and measured.
4. From the measurements, the printer calculates the necessary correction factors to apply for consistent color printing on that paper type. It also calculates the maximum amount of each ink that can be applied to the paper.

Color management from printer drivers

Color management options

The aim of color management is to reproduce colors as accurately as possible on all devices: so that, when you print an image, you see very similar colors as when you view the same image on your monitor.

There are two basic approaches to color management for your printer:

- **Application-Managed Colors:** in this case your application program must convert the colors of your image to the color space of your printer and paper type, using the ICC profile embedded in the image and the ICC profile of your printer and paper type.
- **Printer-Managed Colors:** in this case your application program sends your image to the printer without any color conversion, and the printer converts the colors to its own color space. The details of this process depend on the graphics language that you are using.
 - **PostScript (PostScript printers):** the PostScript interpreter module performs the color conversion using the profiles stored in the printer and any additional profiles sent with the PostScript job. This kind of color management is done when you are using the PostScript driver and you specify printer color management or when you send a PostScript, PDF, TIFF or JPEG file directly to the printer through the Embedded Web Server. In either case you have to select the profiles to use as default (in case the job doesn't specify any) and the rendering intent to apply.
 - **Non-PostScript (PCL3GUI, HP-GL/2):** the color management is done using a set of stored color tables. ICC profiles are not used. This method is somewhat less versatile than the alternatives, but is a little simpler and faster, and can produce good results with standard HP paper types. This kind of color management is done when you are using a non-PostScript driver and you specify printer color management, or when you send a PCL3GUI or HP-GL/2 file directly to the printer through the Embedded Web Server.



NOTE: There are only two color spaces that the printer can convert to its own color space using the stored color tables: Adobe RGB and sRGB if you are using Windows, Adobe RGB and ColorSync if you are using Mac OS X.

ColorSync is the Mac OS X built-in Color Management System; so, when you select ColorSync, color management is performed by Mac OS X, and it is done based on the ICC profiles of the specified paper type.

ColorSync can be selected from the **Color Matching** panel.

You are recommended to consult the HP Support Center (see [HP Support Center on page 241](#)) to see how to use the color management options of your particular application.

To choose between **Application-Managed Colors** and **Printer-Managed Colors**:

- **In the Windows driver dialog:** select the **Color** tab.
- **In the Mac OS X Print dialog:** select the **Color Options** panel.
- **In some applications:** you can make this choice in the application.

Printer emulation

If you want to print a particular job and to see approximately the same colors that you would get from printing the same job on a different HP DesignJet printer, you can use the emulation mode provided by your printer.

 **NOTE:** This option is available only when printing an HP-GL/2, PostScript or PDF job. Accuracy is guaranteed only when printing on plain, coated, or heavyweight coated paper.

- **In the Windows HP-GL/2 or PostScript driver dialog:** select the **Color** tab, then **Printer Managed Colors**, then select **Printer Emulation** from the Source Profile list. You can then select from the Emulated Printer list.

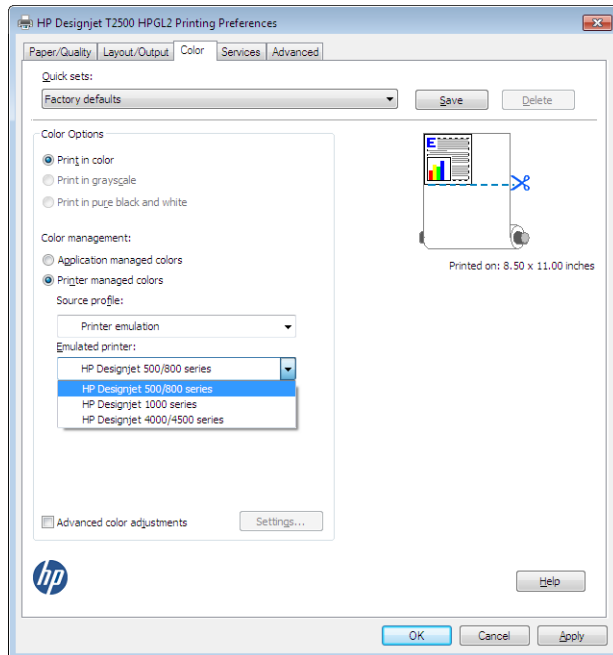

- **In the Mac OS X Print dialog:** select the **Color Options** panel, then select from the Printer Emulation list.

Color adjustment options

The aim of color management is to print accurate colors. If you perform color management correctly, then you should be able to print accurate colors with no need of any manual color adjustments.

However, manual adjustments may be useful in the following situations:

- If your color management is not working correctly for some reason
- If you want colors that are subjectively pleasing rather than accurate

The printer driver provides different adjustment facilities depending on whether you are printing in color or in grayscale. If you are printing in pure black and white, there are no color adjustment options.

Printing in color

You can adjust the colors of your print as follows.

- **In the Windows driver dialog:** select the **Color** tab, ensure that the **Advanced color adjustments** box is checked, then press the **Settings** button beside it.

You can then make adjustments using a lightness slider and three color sliders.

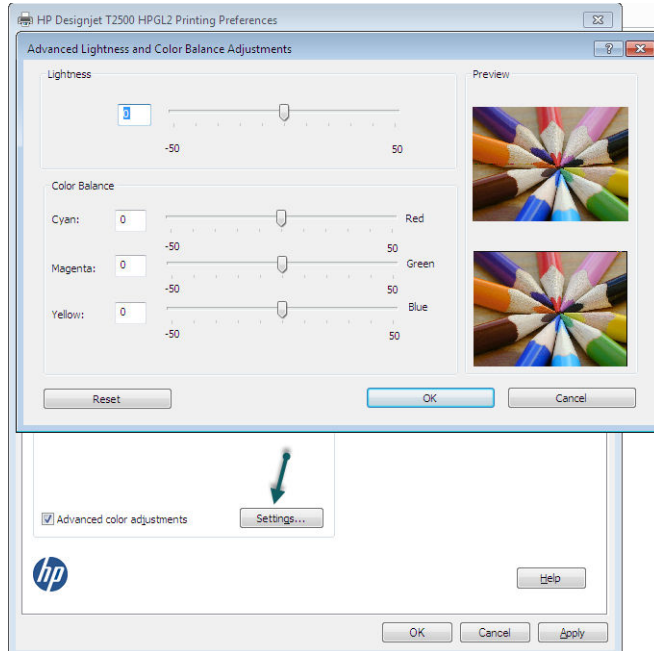

- The lightness slider simply makes the whole print lighter or darker.
- The color sliders can be used to fade or emphasize each of the primary colors in the print. The primary colors may be red, green and blue; or cyan, magenta and yellow; depending on the color model used in the image.

The **Reset** button restores each slider to its default central position.

Printing in grayscale

You can convert all colors in your image to shades of gray in the following ways:

- **In your application program:** many programs provide this option.
- **In the Windows driver dialog:** go to the **Color** tab and look at the Color Options section. Select **Print in Grayscale**. You can also select **Print in pure black and white** if you want only black and white, without gray shades.
- **In the Mac OS X Print dialog:** go to the **Color Options** panel and select **Grayscale** from the Mode drop-down list. You can also select **Pure Black and White** if you want only black and white, without gray shades.
- **On the Embedded Web Server's Submit Job page:** select **Color**, then set **Color/Grayscale** to **Print In Grayscale**. You can also select **Pure Black and White** if you want only black and white, without gray shades.

You can adjust the gray balance of your print under Windows:

- **In the Windows driver dialog:** select the **Color** tab, ensure that the **Advanced color adjustments** box is checked, then press the **Settings** button beside it.

You will then be able to make adjustments using separate controls for highlights, midtones and shadows.

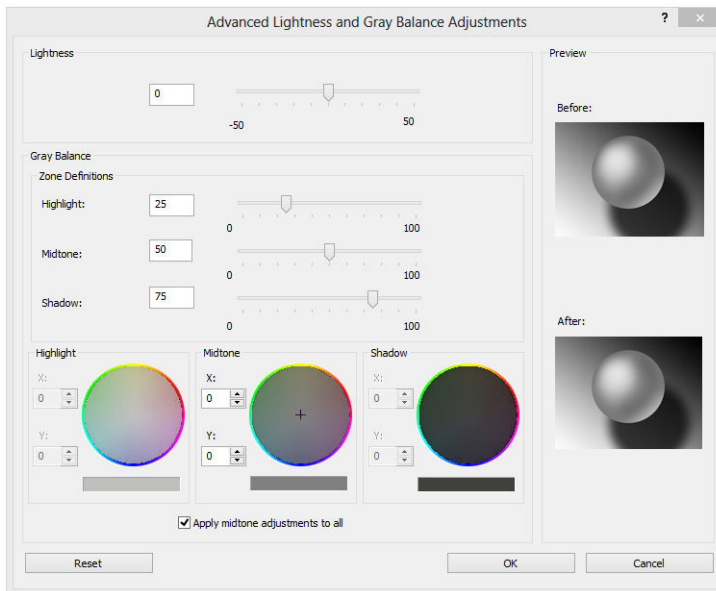

- The lightness slider simply makes the whole print lighter or darker. This slider is available in the same window as the other grayscale controls.
- The zone definition sliders can be used to define what you mean by highlight, midtone and shadow.
- The other controls for highlight, midtone and shadow can be used to adjust the gray balance of highlights, midtones and shadows respectively.

The **Reset** button restores each control to its default setting.

 **TIP:** To emulate grayscale printing from older DesignJet printers, you can convert the file to be printed to grayscale using an image editing program, and then use Print in Color and the appropriate emulation in the driver.

Color management from printer drivers (PostScript printers)

This facility is available when printing with the PostScript driver.

HP Professional PANTONE Emulation

When you use a named PANTONE color in an image, your application will normally send to the printer a CMYK or RGB approximation to that color. But the application does not take the printer or the paper type into account, it merely produces a generic approximation of the PANTONE color, which will look different on different printers and on different papers.

HP Professional PANTONE Emulation can do a much better job by taking into account the characteristics of the printer and the paper type. The results look as similar to the original PANTONE colors as is possible on a given printer using a given paper type. This technology is designed to produce emulations similar to those set up manually by prepress professionals.

To use HP Professional PANTONE Emulation, all you have to do is to turn it on. In fact, it is normally on by default.

- **In the Windows PostScript driver dialog:** go to the **Color** tab and select **HP Professional PANTONE Emulation**.
- **In the Mac OS X PostScript Print dialog:** go to the **Color Options** panel and select **HP Professional PANTONE Emulation**.

Color emulation

Your printer can emulate the color behavior of other devices: RGB devices such as monitors, and CMYK devices such as presses and printers.

You can set color emulation in the following ways:

- **In the Windows PostScript driver dialog:** select the **Color** tab, and **Printer Managed Colors**.
- **In the Mac OS X Print dialog:** select the **Color Options** panel, then select **Printer Emulation** from the Color Management list.

For a good emulation, the printer needs a specification of ICC of the colors these devices can reproduce. The standard way of encapsulating such information is in ICC profiles. As part of the solution, we provide the most common standards for the different devices.

The options are as follows.

CMYK color emulation

A traditional workflow defines color in the CMYK space. For best results, the colors must be adjusted to the printer, because different printers will produce different colors from the same CMYK data. If the image file you are printing was not created specifically for your printer, it will require some readjustment, which can be done using one of the following options provided with your printer.

- **None (Native):** no emulation. The printer will use its default internal conversion from CMYK to RGB, without following any color standard. This does not imply that results will be bad
- **ISO Coated 2-ECI** is based on the characterization dataset FOGRA39L.txt, applicable to the following reference printing conditions according to the international standard ISO 12647-2:2004/Amd 1: commercial and specialty offset, paper type 1 and 2, gloss or matt coated paper, positive plates, tone value increase curves A (CMY) and B (K), white backing.
- **Coated GRACoL 2006-ISO12647** provides GRACoL proofing and printing on Grade 1 coated paper, ISO 12647-2 Paper type 1.
- **PSO Uncoated ISO12647-ECI** is based on the characterization data set FOGRA47L.txt, applicable to the following reference printing condition according to the international standards ISO 12647-2:2004 and ISO 12647-2:2004/Amd 1:2007: commercial and specialty offset, paper type 4, uncoated white paper, positive plates, tone value increase curves C (CMY) and D (K), white backing.
- **PSO LWC Improved-ECI** is based on the characterization data set FOGRA45L.txt, applicable to the following reference printing condition according to the international standards ISO 12647-2:2004 and ISO 12647-2:2004/Amd 1:2007: commercial and specialty offset, improved LWC paper (light weight coating), positive plates, tone value increase curves B (CMY) and C (K), white backing.
- **Web Coated SWOP 2006 Grade 3** provides SWOP® proofing and printing on U.S. Grade 3 coated publication paper.
- **Web Coated SWOP 2006 Grade 5** provides SWOP® proofing and printing on U.S. Grade 5 coated publication paper.

- **U.S. Sheetfed Coated 2** uses specifications designed to produce quality separations using U.S. inks under the following printing conditions: 350% total area of ink coverage, negative plate, bright white offset stock.
- **U.S. Sheetfed Uncoated 2** uses specifications designed to produce quality separations using U.S. inks under the following printing conditions: 260% total area of ink coverage, negative plate, uncoated white offset stock.
- **U.S. Web Coated (SWOP) 2** uses specifications designed to produce quality separations using U.S. inks under the following printing conditions: 300% total area of ink coverage, negative plate, coated publication-grade stock.
- **U.S. Web Uncoated 2** uses specifications designed to produce quality separations using U.S. inks under the following printing conditions: 260% total area of ink coverage, negative plate, uncoated white offset stock.
- **Euroscale Uncoated 2** uses specifications designed to produce quality separations using Euroscale inks under the following printing conditions: 260% total area of ink coverage, positive plate, uncoated white offset stock.
- **Japan Web Coated (Ad)** uses specifications developed by the Japan Magazine Publisher Association for digital proofing of images in the Japanese magazine/advertising market.
- **Japan Color 2001 Coated** uses the Japan Color 2001 specification for type 3 (coated) paper. It is designed to produce quality separations using 350% total ink coverage, positive film and coated paper.
- **Japan Color 2001 Uncoated** uses the Japan Color 2001 specification for type 4 (uncoated) paper. It is designed to produce quality separations using 310% total ink coverage, positive film and uncoated paper.
- **Japan Color 2002 Newspaper** uses the Japan Color 2002 for Newspapers specification. It is designed to produce quality separations using 240% total ink coverage, positive film and standard newsprint paper.
- **Japan Color 2003 WebCoated** is for type 3 coated paper. It is designed to produce quality separations for standard ISO printing using 320% total ink coverage, positive film, and coated paper on heat-set web offset presses.
- **JMPA:** Japanese standard for offset press.
- **Toyo** is designed to produce quality separations for Toyo printing presses.
- **DIC** is designed to produce quality separations for Dainippon Ink Company printing presses.

 **NOTE:** These options have no effect if the application is defining its own CMYK space, known as calibrated CMYK or CIEBasedDEFG in PostScript terminology.

RGB color emulation

Your printer is provided with the following color profiles:

- **None (Native):** no emulation, for use when the color conversion is done by the application or operating system, and therefore the data arrive at the printer already color-managed.
- **sRGB IEC61966-2.1** emulates the characteristics of the average PC monitor. This standard space is endorsed by many hardware and software manufacturers, and is becoming the default color space for many scanners, printers and software applications.

- **ColorMatch RGB** emulates the native color space of Radius Pressview monitors. This space provides a smaller gamut alternative to Adobe RGB (1998) for print production work.
- **Apple RGB** emulates the characteristics of the average Apple monitor, and is used by a variety of desktop publishing applications. Use this space for files that you plan to display on Apple monitors, or for working with old desktop publishing files.
- **Adobe RGB (1998)** provides a fairly large gamut of RGB colors. Use this space if you need to do print production work with a broad range of colors.

Color management from the Embedded Web Server

Submit Job options

When you send jobs to the printer using the Embedded Web Server's **Submit Job** page, you have the following color management options.

If you leave an option set to **Default**, the setting saved in the job will be used. If the job contains no setting, the front-panel setting in the printer will be used.

- **Color/Grayscale:** you can choose to print in color, in shades of gray, or in pure black and white.
- **Default RGB source profile:** you can choose from a selection of RGB source profiles recognized by the printer.
- **Printer emulation:** you can choose to emulate a different HP DesignJet printer. Default: **Off** (no printer emulation).

T2500 PS options (with PostScript or PDF jobs)

- **Default CMYK source profile:** you can choose from a selection of CMYK source profiles recognized by the printer. Default: **US Coated SWOP v2**.
- **Rendering intent:** you can select the rendering intent.
- **Black point compensation:** you can turn black point compensation on or off.
- **HP Professional PANTONE Emulation:** you can turn HP Professional PANTONE Emulation on or off.

Rendering intent

Rendering intent is one of the settings used when doing a color transformation. As you probably know, some of the colors you want to print may not be reproducible by the printer. The rendering intent allows you to select one of four different ways of handling these so-called out-of-gamut colors.

- **Saturation (graphics):** best used for presentation graphics, charts or images made up of bright, saturated colors.
- **Perceptual (images):** best used for photographs or images in which colors blend together. It tries to preserve the overall color appearance.
- **Relative colorimetric (proofing):** best used when you want to match a particular color. This method is mainly used for proofing. It guarantees that, if a color can be printed accurately, it will be printed accurately. The other methods will probably provide a more pleasing range of colors but do not



guarantee that any particular color will be printed accurately. It maps the white of the input space to the white of the paper on which you are printing.



- **Absolute colorimetric (proofing):** the same as relative colorimetric, but without mapping the white. This rendering is also used mainly for proofing, where the goal is to simulate the output of one printer (including its white point).

Perform black point compensation

The black point compensation option controls whether to adjust for differences in black points when converting colors between color spaces. When this option is selected, the full dynamic range of the source space is mapped into the full dynamic range of the destination space. It can be very useful in preserving shadows when the black point of the source space is darker than that of the destination space. This option is allowed only when the **Relative colorimetric** rendering intent is selected (see [Rendering intent on page 112](#)).

Color management from the front panel

You can color-calibrate the loaded paper type from the front panel by pressing , then , then **Image quality maintenance > Calibrate color**. See [Color calibration on page 104](#).

The other color options in the front panel can all be found by pressing , then , then **Setup > Printing preferences > Color options**.

 **NOTE:** These front panel settings can all be overridden by the printer driver or Embedded Web Server job submission settings.

- **Color/Grayscale:** you can choose to print in color, in shades of gray, or in black and white. Default: **Print in color**.
- **Select RGB source profile:** you can choose from a selection of RGB source profiles recognized by the printer. Default: **sRGB**.
- **Emulate printer:** you can choose to emulate a different HP DesignJet printer. Default: **Off** (no printer emulation).

 **TIP:** If you have old HP-GL/2 or PostScript files made for a different HP DesignJet printer, you can send them to the printer and use the front panel to turn on the appropriate emulation mode.

T2500 PS options (with PostScript or PDF jobs)

- **Select CMYK source profile:** you can choose from a selection of CMYK source profiles recognized by the printer. Default: **US Coated SWOP v2**.
- **Select rendering intent:** you can select the rendering intent. Default: **Perceptual**.
- **Black point compensation:** you can turn black point compensation on or off. Default: **On**.
- **HP Professional PANTONE Emulation:** you can turn HP Professional PANTONE Emulation on or off. Default: **On**.

Color management and the scanner

The files obtained from your scanner (TIFF, JPEG, PDF) contain an embedded ICC profile corresponding to the type of paper selected prior to making the scan. When you load these files into any image reader software

application, the information of the ICC profile is automatically used for optimum color appearance on your monitor. When you print a scanned image, or copy an original, the embedded ICC profile is also automatically used by the printer for optimum printing results.

14 Practical printing examples

- [Print from Adobe Acrobat](#)
- [Print from Autodesk AutoCAD](#)
- [Print from Adobe Photoshop](#)
- [Print and scale from Microsoft Office](#)

For printing examples using HP DesignJet ePrint & Share, see <http://www.hp.com/go/eprintandshare>.

Print from Adobe Acrobat

1. In the Acrobat window, move the mouse cursor to the bottom left corner of the document pane until the document size appears there.

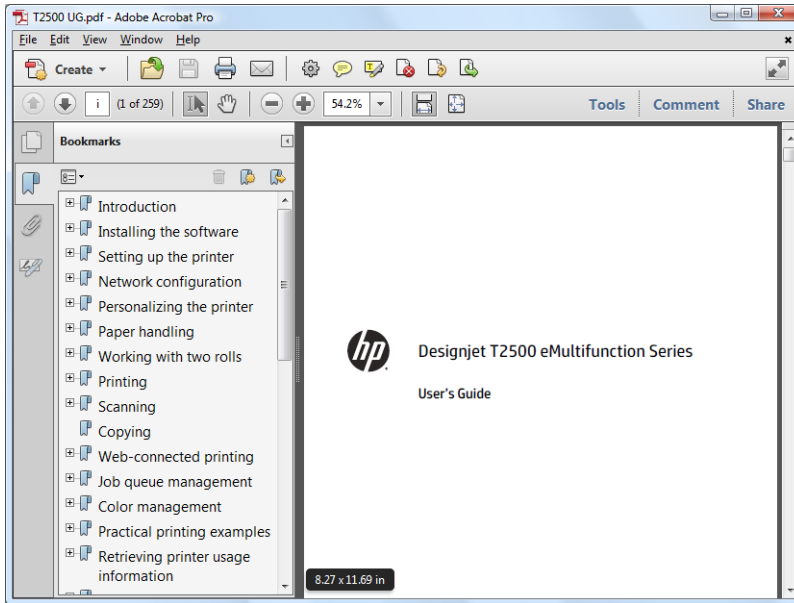

2. Select **File > Print** and ensure that **Page Scaling** is set to **None**.

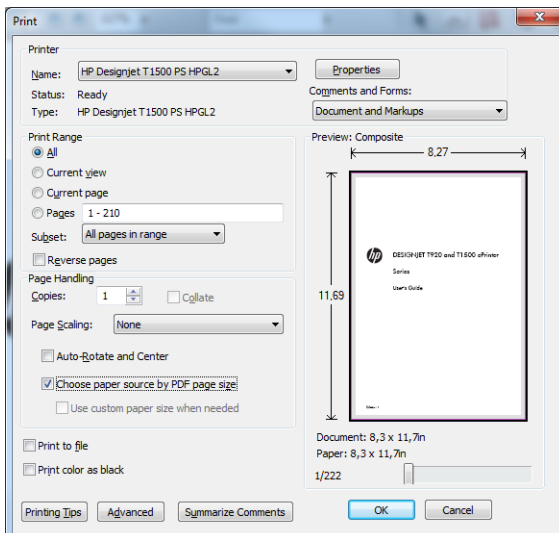

 **NOTE:** The page size will **not** be automatically selected according to the document size.

3. Press the **Properties** button and then select the **Paper/Quality** tab.

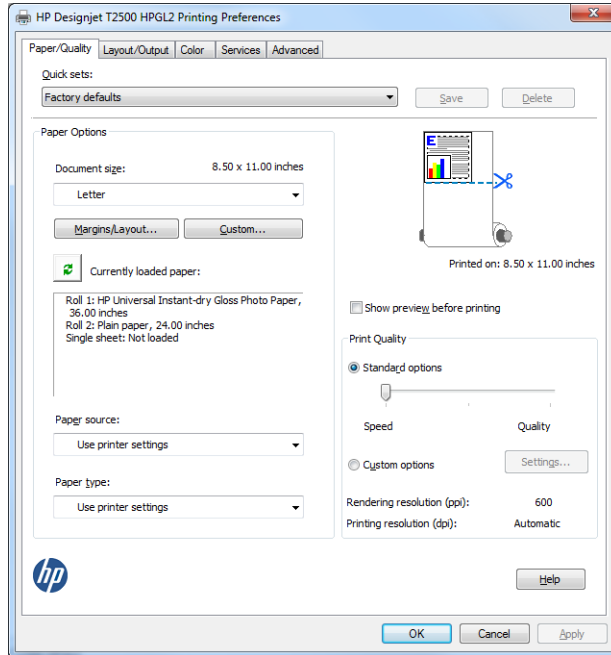

4. Choose whatever **Document Size** and **Print Quality** you want to use. If you want to define a new custom paper size, press the **Custom** button.

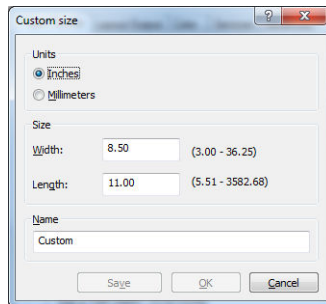

5. Select the **Layout/Output** tab, and then **Autorotate**.

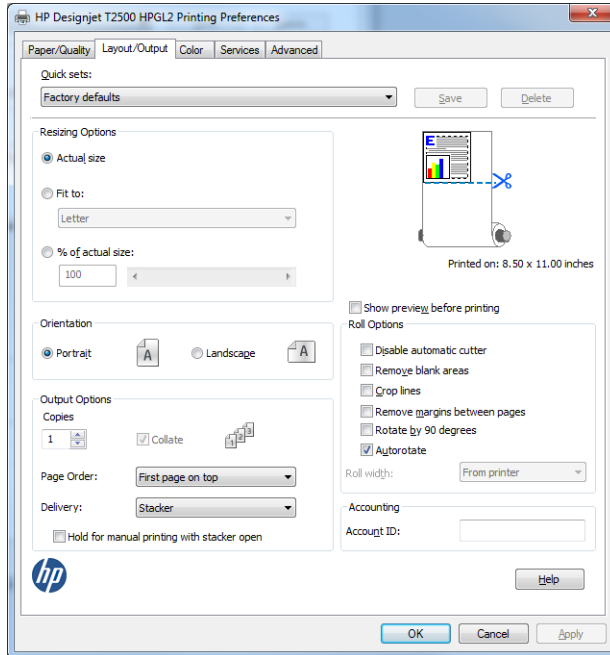

6. Click **OK**, and check that the print preview in the Print dialog box seems correct.

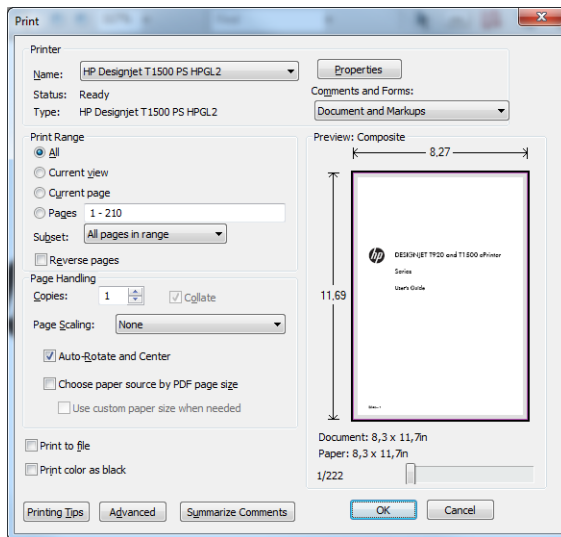

Print from Autodesk AutoCAD

1. The AutoCAD window can show a model or layout. Normally a layout is printed rather than the model.

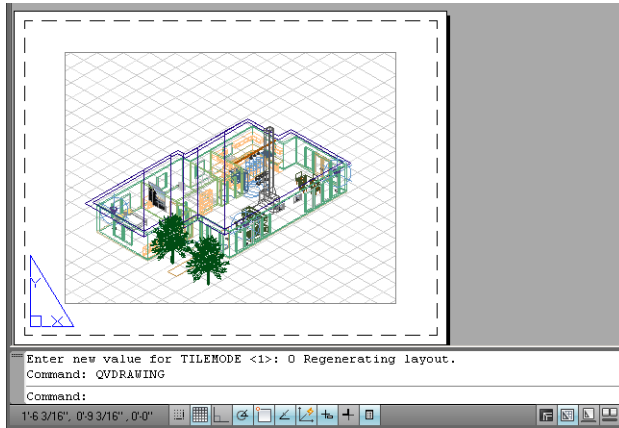

2. Click the Plot icon at the top of the window.

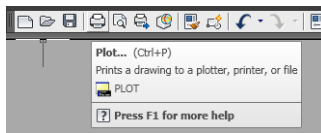

3. The Plot window opens. You can see further options by pressing the circular button in the lower right corner of the window.

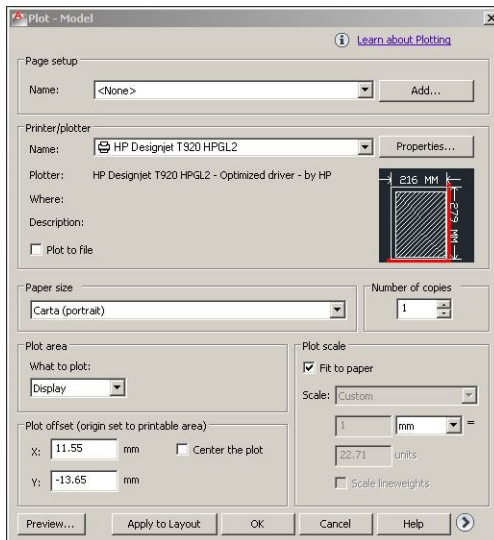

4. Press the **Properties** button.

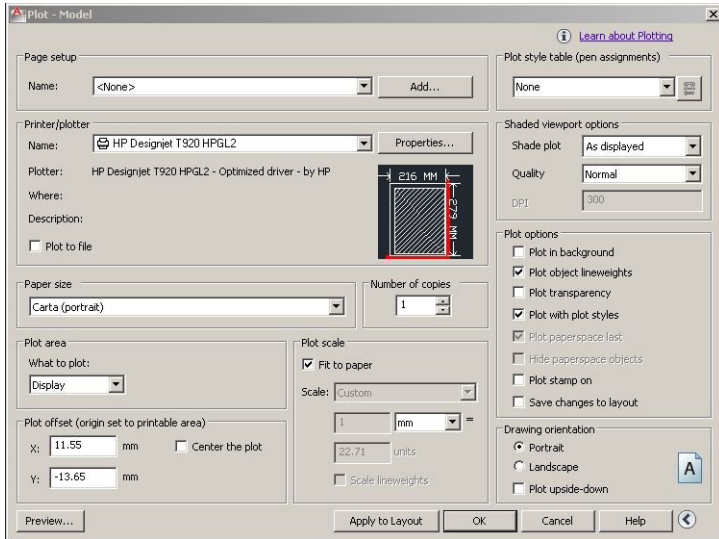

5. Select the **Device and Document Settings** tab, and press the **Custom Properties** button.

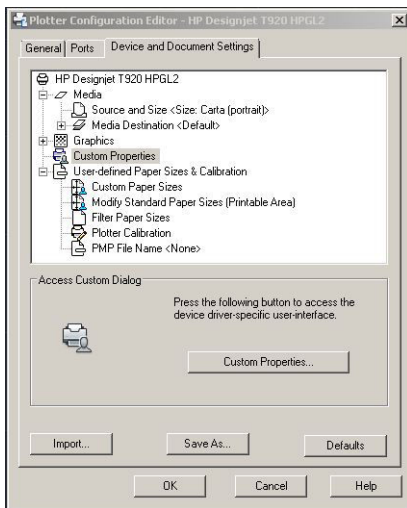

6. In the **Paper/Quality** tab, select the paper type that you intend to use, and the print quality (your own choice between high speed and high quality).

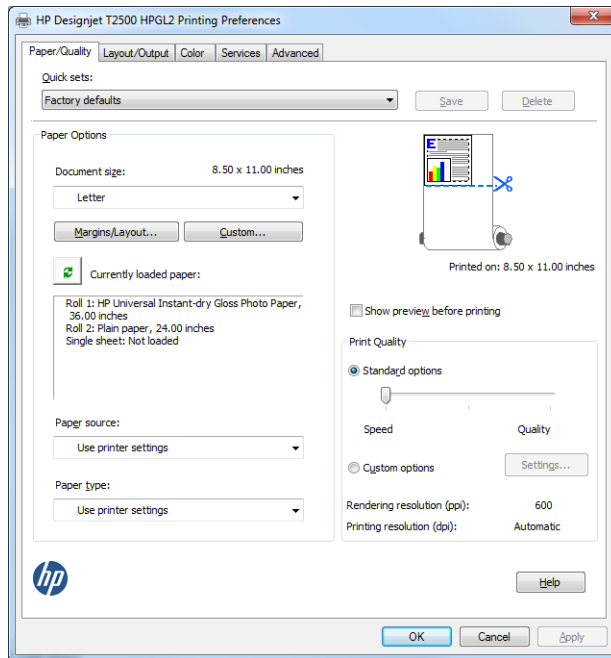

7. Press the **Margins/Layout** button for additional layout options.

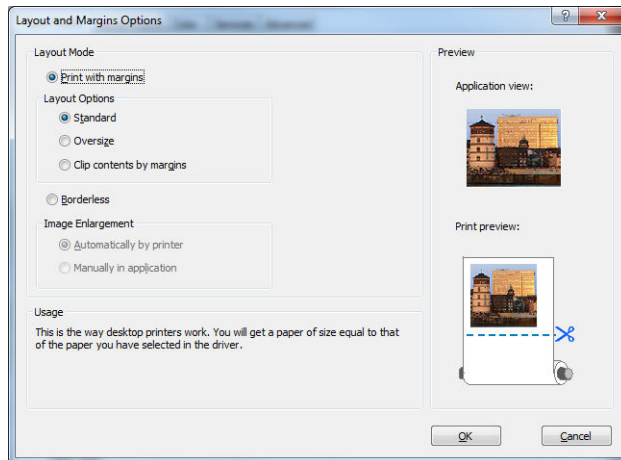

8. If you intend to print on roll paper, you must decide where the printer should cut the paper. In the **Layout/Output** tab, check or uncheck the **Disable automatic cutter** option, and check the **Autorotate** option, which can help to avoid wasting paper.

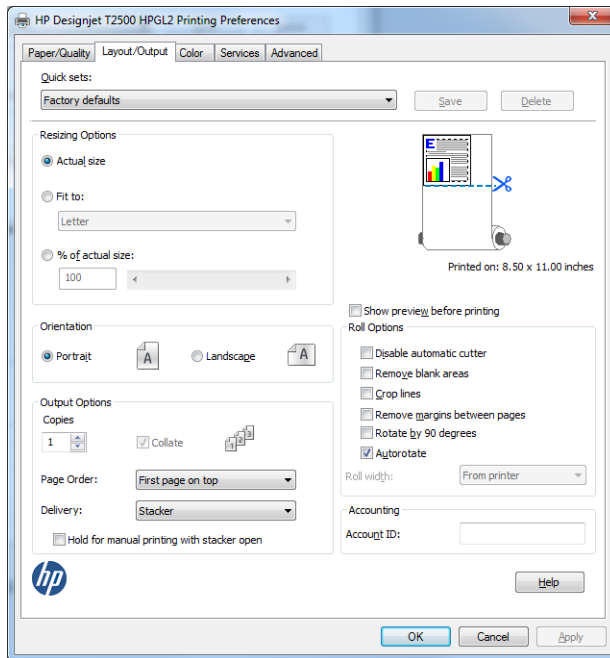

9. Press the **OK** button and save your configuration changes to a PC3 file.

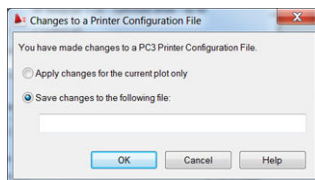

Using printer emulation

Printer emulation can be requested by selecting **Advanced settings > Color > Color management > Printer Managed Colors > Printer emulation**.

You can select **Off** (no printer emulation) or the name of the printer model that you want to emulate.

This setting will apply to jobs that do not contain any printer emulation setting saved in the job.

Using clip contents by margins

You can select this margins option from **Advanced settings > Paper/Quality > Margins/Layout > Print with margins > Layout > Clip contents by margins**.

Use this option when the contents to be printed have white borders and a size equal to that of the paper you have selected. The printer will use the white border for its margins and you will get a page of size equal to that which is selected in the driver.

Print from Adobe Photoshop

1. In Photoshop CS5, select **File > Print**, then select your printer and press **Print Settings**.

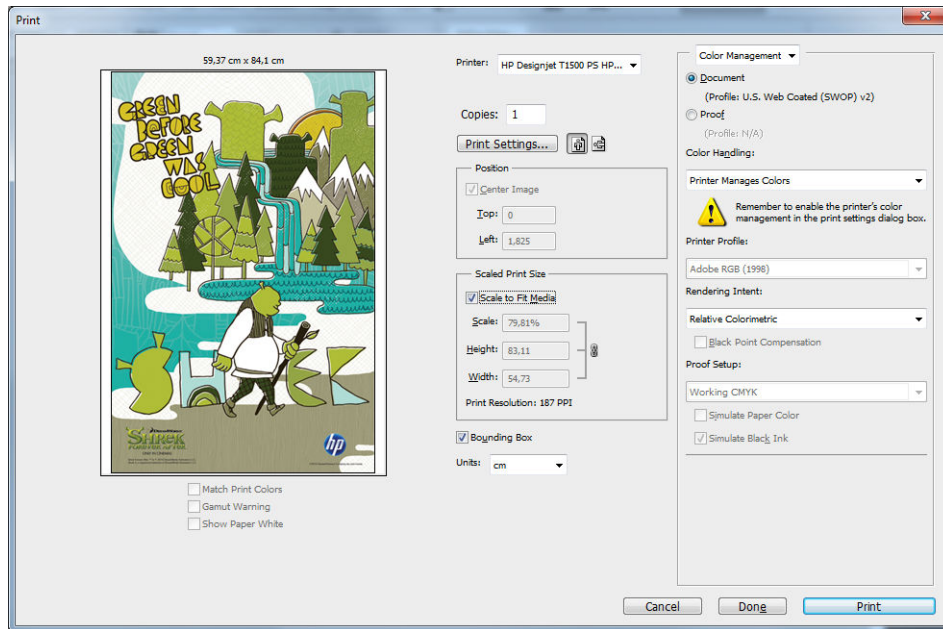

2. Choose from the available document sizes.

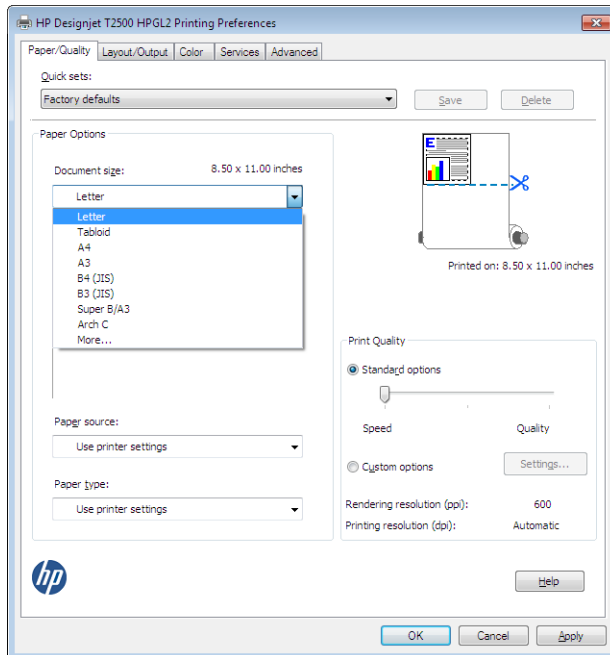

If you do not find the size that you intend to use, press the **Custom** button. Enter the width, the length, and the name of your custom size. Press the **Save** and **OK** buttons.

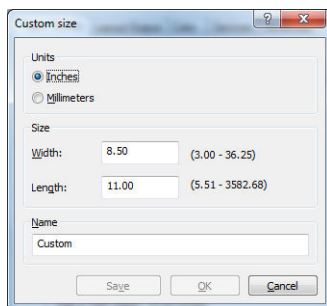

3. You may wish to change the default paper source, paper type, and print quality.

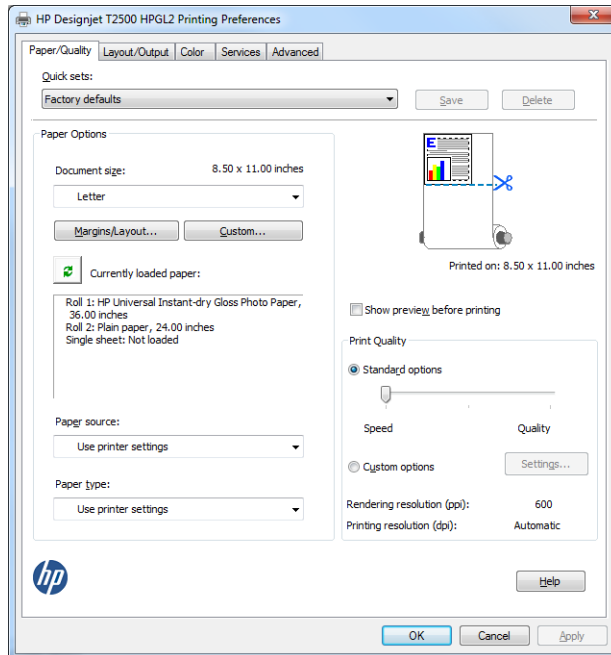

4. In the **Color** tab, the default color management option is **Printer managed colors**, and this is the correct option because you have already selected **Printer Manages Colors** in Photoshop.

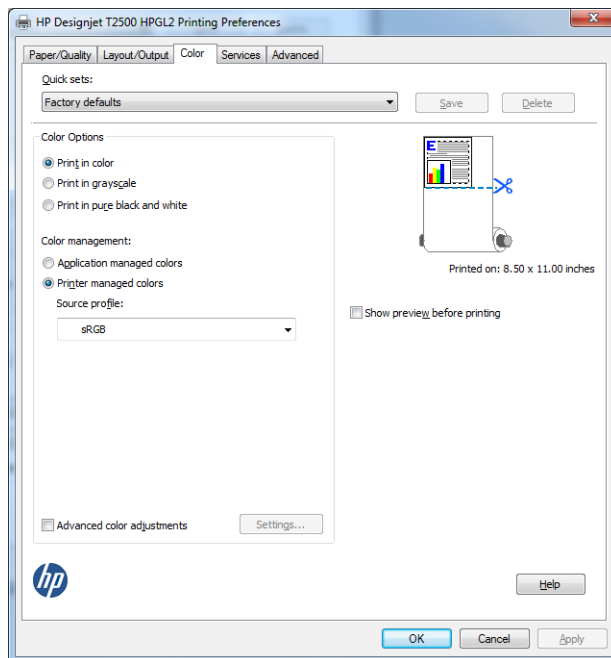

Print and scale from Microsoft Office

This section demonstrates how to print and scale from Microsoft Office 2010.

Using PowerPoint

1. Select the **File** tab, then **Print**, and select the name of your printer.

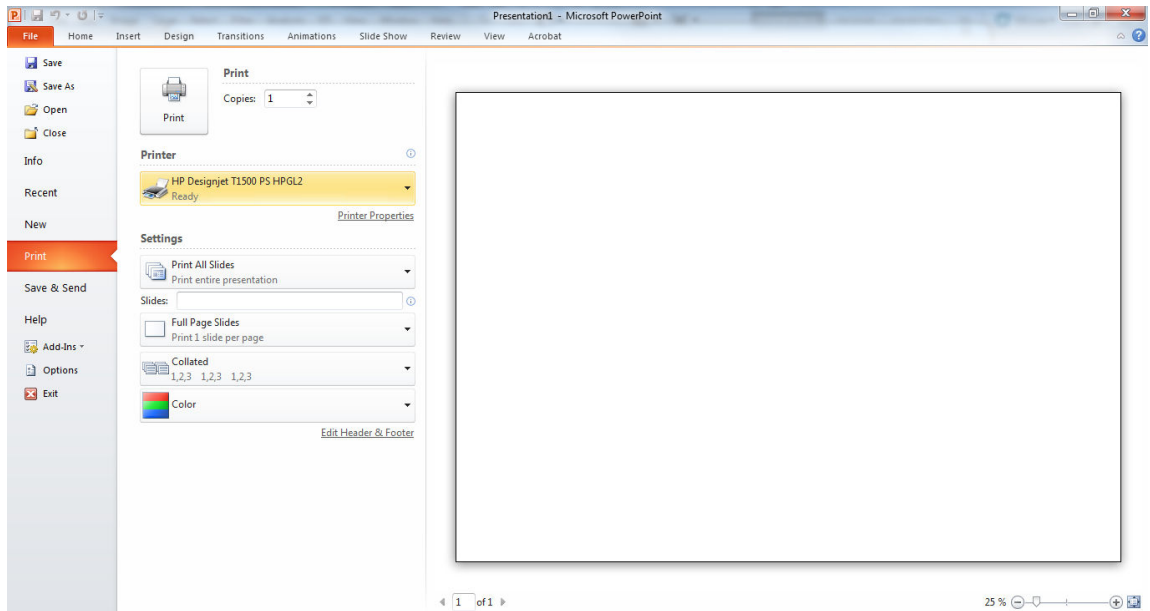

2. Select **Printer Properties** > **Layout/Output** > **Fit to** to scale the document to a particular size.

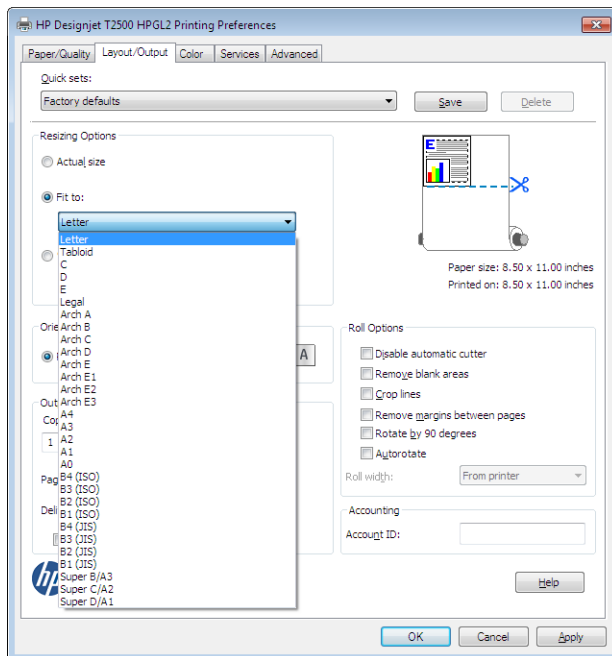

3. Select the **Paper/Quality** tab, then select **Paper Source** and **Paper Type**.

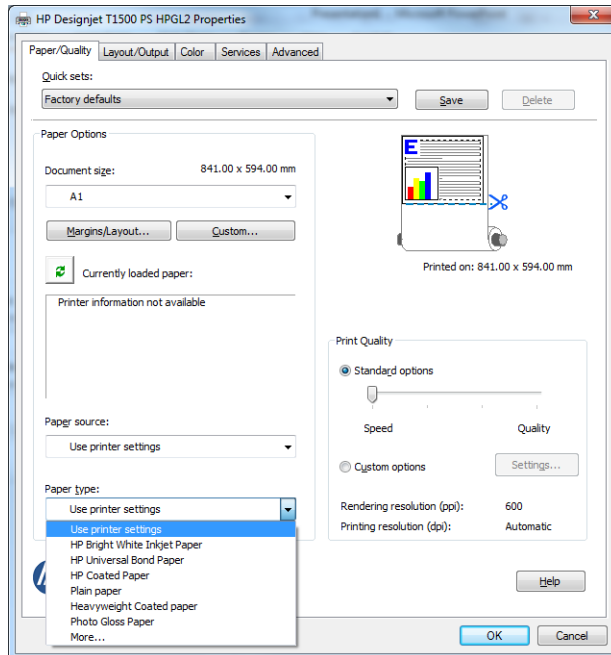

4. Select **Margins/Layout**, then select **Clip contents by margins** to keep the size.

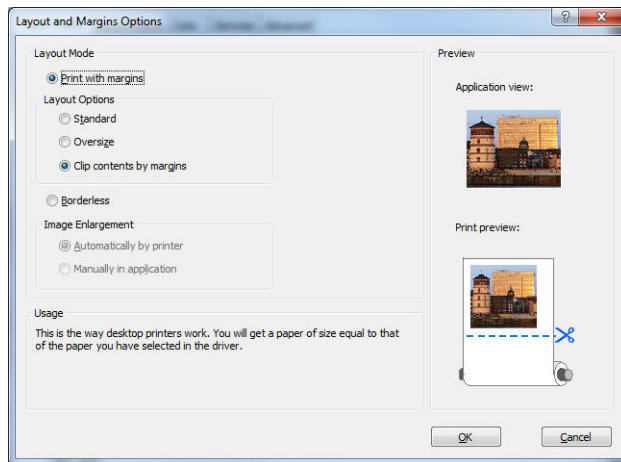

Using Project

1. Select **File > Page Setup > Print**.

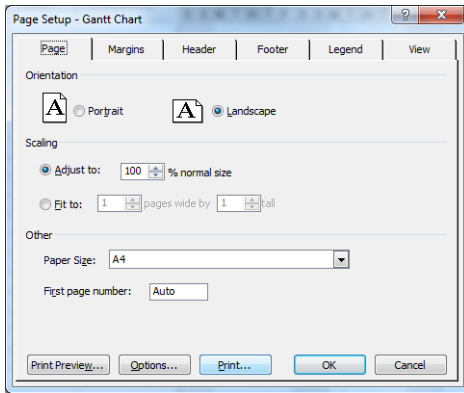

2. Select your printer's name, then **Close**.

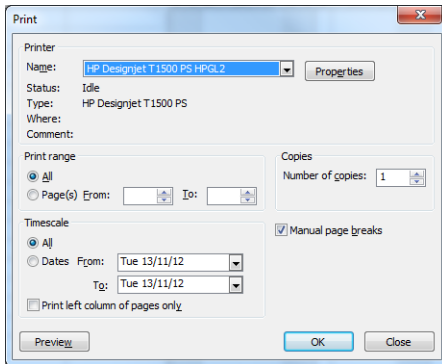

3. Select **Page Setup**, and choose the **Paper Size** you want.

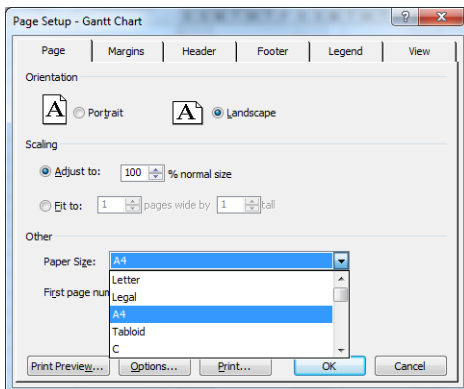

4. Select **Options** to go to the printer driver. The default options in the **Paper/Quality** tab are probably suitable: **Paper source: Use printer settings** and **Paper Type: Use printer settings**.

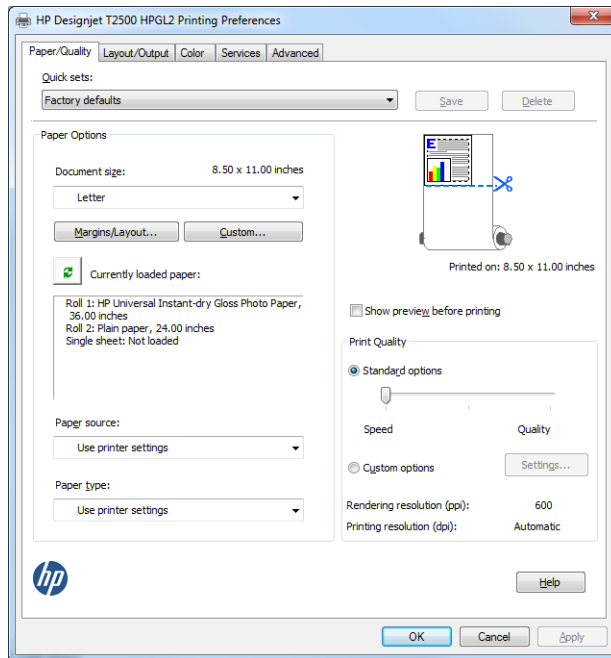

5. Select **Layout/Output** > **Fit to** to scale the document to a particular size. Alternatively, you can scale the document in Project.

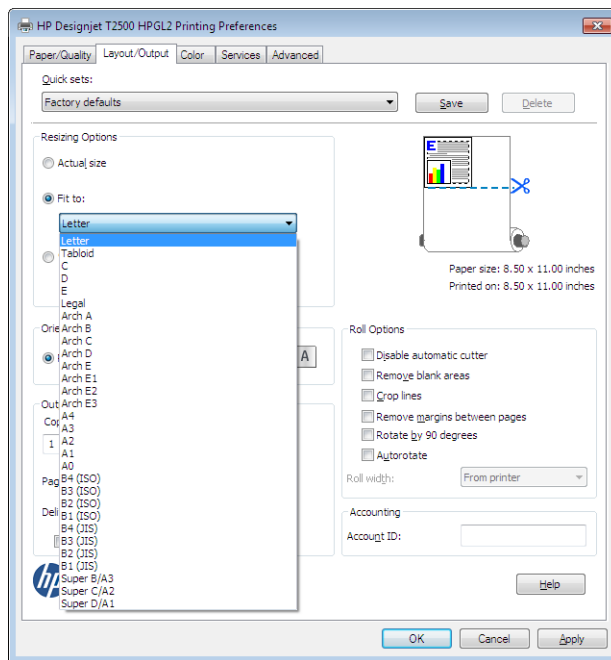

Using Excel

1. Select the **Page Layout** tab, then **Size**, and choose the paper size you want.

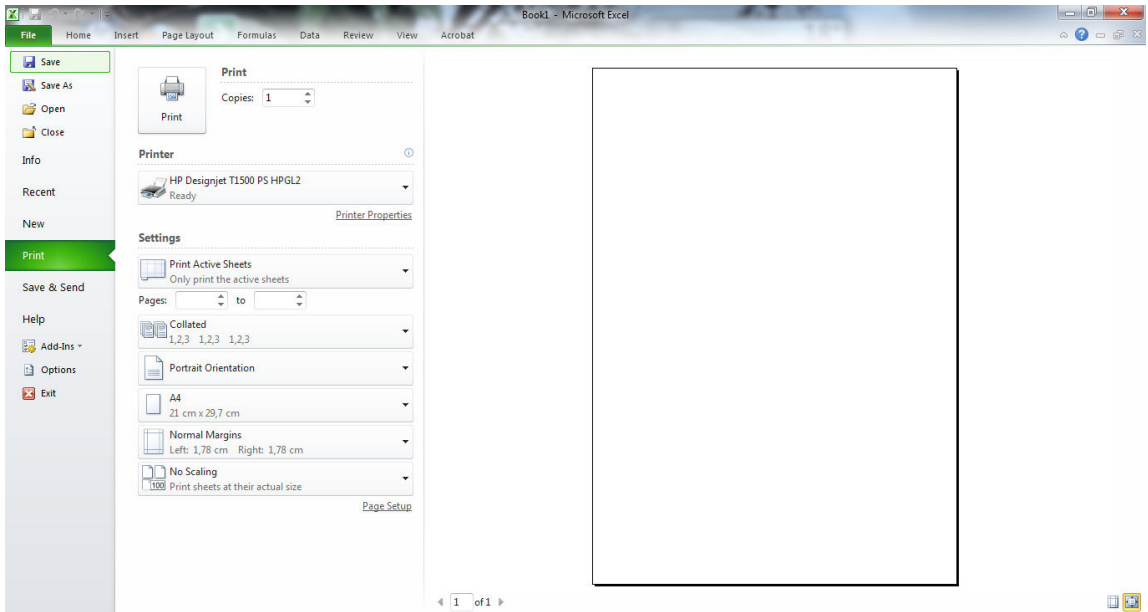

2. Select the **File** tab, then **Print**, and select the name of your printer.

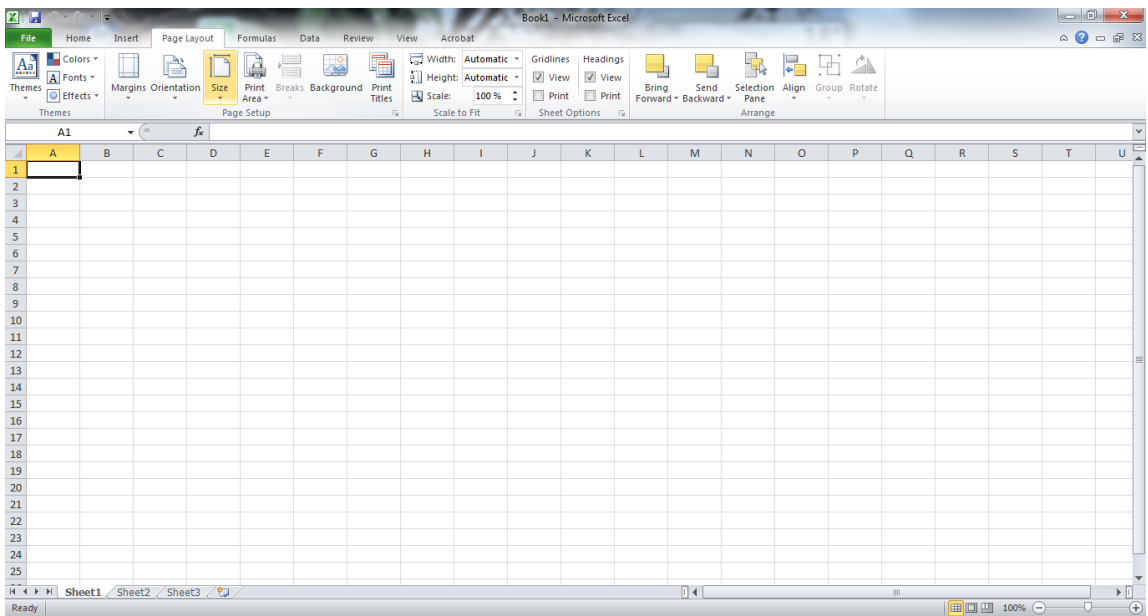

3. Select **Printer Properties** to go to the printer driver. In the **Paper/Quality** tab, select **Paper source**, **Paper Type** and **Print Quality**.

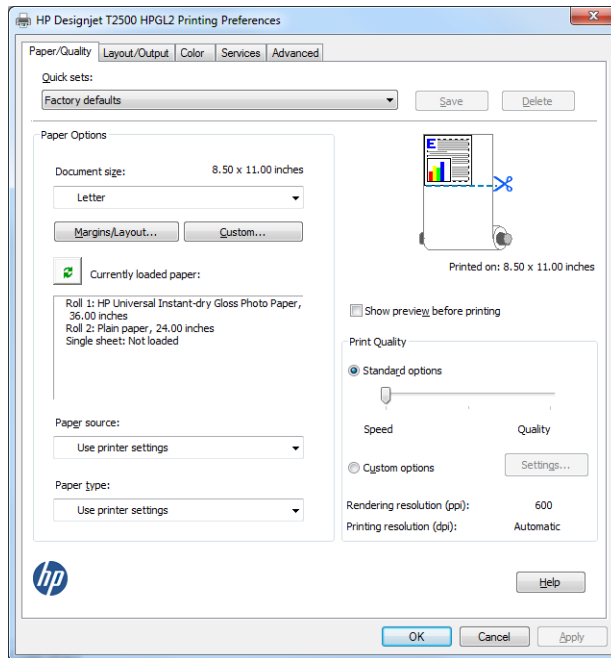

4. Select **Layout/Output** > **Fit to** to scale the document to a particular size. Alternatively, you can scale the document in Excel.

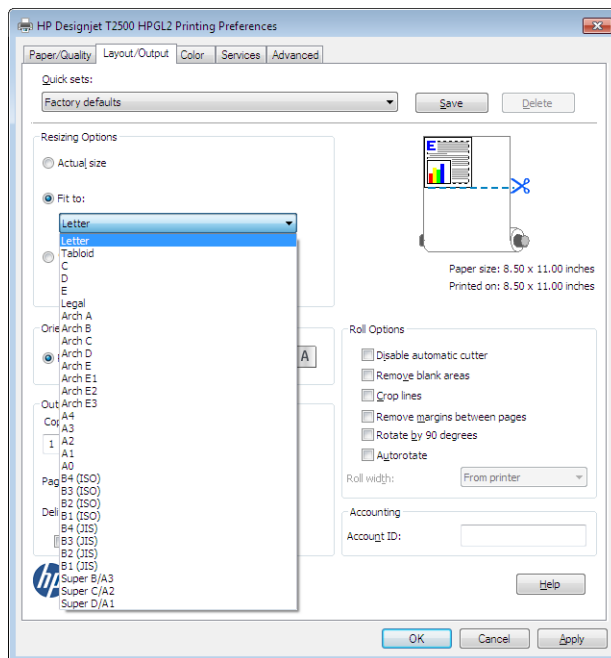

15 Retrieving printer usage information

- [Get printer accounting information](#)
- [Check usage statistics](#)
- [Check usage statistics for a job](#)
- [Request accounting data by email](#)

Get printer accounting information

There are various different ways of getting accounting information from your printer.

- View printer usage statistics for the whole lifetime of the printer, see [Check usage statistics on page 133](#).
- View ink and paper usage for each of your recent jobs by using the HP Utility, see [Check usage statistics for a job on page 133](#). If the HP Utility is not available, see [Access the HP Utility on page 46](#).
- Request accounting data by email. The printer sends data in XML at regular intervals to a specified email address; the data may be interpreted and summarized by a third-party application, or displayed as an Excel spreadsheet. See [Request accounting data by email on page 134](#).
- Use a third-party application to request printer status, printer usage or job accounting data from the printer through the Internet. The printer provides data in XML to the application whenever requested. HP provides a Software Development Kit to facilitate the development of such applications.

Check usage statistics

There are various ways of checking your printer's usage statistics.



NOTE: The accuracy of the usage statistics is not guaranteed.

From the Embedded Web Server



1. Access the Embedded Web Server, see [Access the Embedded Web Server on page 46](#).
2. Go to the **Main** tab.
3. Select **History > Usage**.

From the HP Utility

1. Access the HP Utility, see [Access the HP Utility on page 46](#).
2. In the HP DesignJet Utility for Windows, go to the **Admin** tab and open the Embedded Web Server. Then go to the **Usage** tab in the Embedded Web Server.

In the HP Utility for Mac OS X, select **Information > Printer Usage** and press the **Lookup** button.

From the front panel

1. Press .
2. Press .
3. Press **Internal prints**.
4. Press **User information prints**.
5. Press **Print usage report**.

Check usage statistics for a job

There are two ways to check usage statistics for a particular job.



NOTE: The accuracy of the usage statistics is not guaranteed.

Accounting statistics with the HP Utility

1. Access the HP Utility, see [Access the HP Utility on page 46](#).
2. Under Windows, select the **Job center** and then **Accounting**, which launches the Embedded Web Server. Under Mac OS X, select **Job Accounting** and click the **Look Up** button.

Accounting statistics with the Embedded Web Server

1. Access the Embedded Web Server, see [Access the Embedded Web Server on page 46](#).
2. Go to the **Main** tab.
3. Select **History > Accounting**.

Request accounting data by email

1. Obtain the IP address of the outgoing mail server (SMTP) from your IT department; this is required in order to send email messages.
2. Ensure that the outgoing email server is configured to enable relaying of email messages that the printer will send.
3. Open your Web browser and connect to the printer's Embedded Web Server.
4. Select the **Setup** tab.
5. From the Configuration menu in the left-hand column, select **Date & Time**.
6. Ensure that the printer's date and time have been set correctly.
7. From the Configuration menu, select **Email server**.
8. Enter the IP address of the outgoing mail server (SMTP).
9. Specify an email address for the printer. The latter does not need to be a valid email address; but it should have the form of an email address. It serves to identify the printer when it sends email messages. See [Turn usage information on and off on page 30](#).
10. From the Configuration menu, select **Printer settings**.
11. In the Accounting section, if you set **Require account ID** to **On**, then every time someone sends a print job to the printer, he or she must provide an account ID: for example, an ID corresponding to his or her department or to a specific project or client. If someone sends a job without providing an account ID, the printer will hold the unidentified job in the queue without printing it until an account ID is provided.

If you set **Require account ID** to **Off**, then the printer will print all jobs whether or not they have an account ID.
12. Set **Send accounting files** to Enabled.
13. Set **Send accounting files to** to the email address (or addresses) to which you want the accounting information sent. This may be an address that you have created specifically to receive automatically generated messages from the printer.

14. Set **Send accounting files every** to the frequency with which you want the information sent, choosing a specific number of days or prints.
15. You may want to set **Exclude personal information from accounting email** to **On**, so that the accounting messages will not contain personal information. If this option is **Off**, information such as user name, job name, and account ID will be included.

When you have completed the above steps, the printer will send accounting data by email with the frequency that you specified. The data are provided in XML and can easily be interpreted by a third-party program. The data provided on each print job include when the job was submitted, when the job was printed, the printing time, the type of image, the number of pages, the number of copies, the paper type and size, the amount of each color of ink used and various other attributes of the job. Accounting data are also provided on scan and copy jobs.

You can download an Excel template from HP's Web site (<http://www.hp.com/go/designjet/accounting>) that will enable you to display the XML data more readably in the form of a spreadsheet.

Analysis of the accounting data will enable you to bill customers precisely and flexibly for the use of your printer. You can, for instance:

- Bill each customer for the total amount of ink and paper used by that customer over a particular period.
- Bill each customer separately per job.
- Bill each customer separately for each project, broken down by job.



NOTE: In some circumstances Excel may lose or misplace the decimal point in a number: for instance, the number 5.1806 may be misunderstood as 51806 and displayed as 51,806. This is an Excel problem that cannot be solved by HP.

16 Handling ink cartridges and printhead



- [About the ink cartridges](#)
- [Check the ink cartridges status](#)
- [Remove an ink cartridge](#)
- [Insert an ink cartridge](#)
- [Safe mode](#)
- [About the printhead](#)
- [Check the printhead status](#)
- [Remove the printhead](#)
- [Insert the printhead](#)
- [Storage of anonymous usage information](#)

About the ink cartridges

Ink cartridges store the ink and are connected to the printhead, which distributes the ink on the paper. To purchase additional cartridges, see [Supplies and accessories on page 165](#).

CAUTION: Observe precautions when handling ink cartridges because they are ESD-sensitive devices (see the [Glossary on page 250](#)). Avoid touching pins, leads and circuitry.

Check the ink cartridges status

To view the ink levels of your ink cartridges, press  on the front panel, then . There is a **Replace ink cartridges** option on the ink information page in case you want to do so (see also [Remove an ink cartridge on page 137](#)).

To get more information on your ink cartridges, you can press the color of the cartridge on which you want information.

You can also get this information from the HP Utility.

For an explanation of the ink cartridge status messages, see [Ink cartridge status messages on page 227](#).

HP Utility procedures

- In the HP DesignJet Utility for Windows, go to the **Supplies** tab.
- In the HP Utility for Mac OS X, select **Printer Status** in the Information group.

Remove an ink cartridge

There are three occasions when you need to remove an ink cartridge.

- The ink cartridge is very low and you want to replace it with a full cartridge for unattended printing (you can use up the remaining ink in the first cartridge at a more convenient time).
- The ink cartridge is empty or faulty, and you must replace it to continue printing.
- You want to replace the printhead, and there is not enough ink left in the ink cartridge to complete the printhead replacement process. In this case, if the cartridge is not empty you can use it again later.

CAUTION: Do not try to remove an ink cartridge while printing.

CAUTION: Remove an ink cartridge only if you are ready to insert another one.

CAUTION: Make sure the printer wheels are locked (the brake lever is pressed down) to prevent the printer from moving.

 **NOTE:** When a cartridge runs out of ink, the current job is not automatically cancelled: unless you cancel it manually, it will resume printing when the empty cartridge has been replaced. If there is a delay in replacing the cartridge, you may see some banding on the print.

1. From the front panel, press , then , then **Replace ink cartridges**.

Alternatively, press , then , then **Ink > Replace ink cartridges**.

2. Open the ink cartridge cover on the left- or right-hand side of the printer.

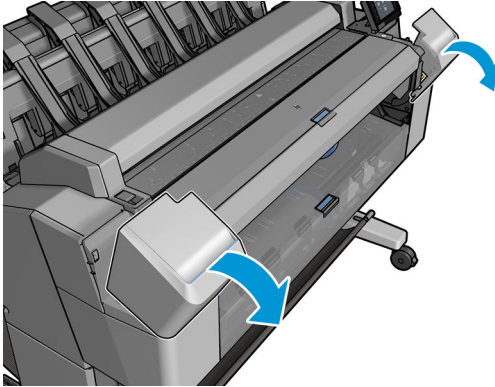

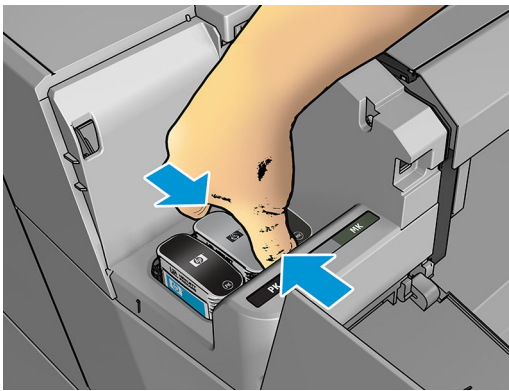

3. Grip the cartridge you wish to remove.

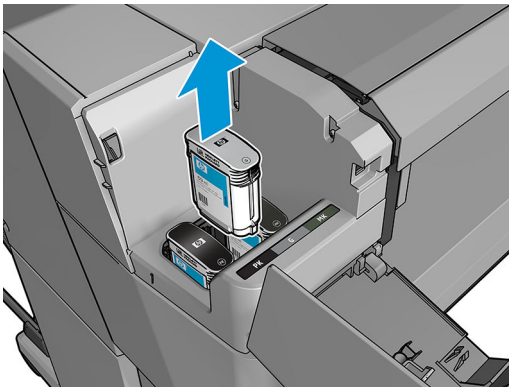

4. Pull the cartridge straight up.



 **NOTE:** Avoid touching the end of the cartridge that is inserted into the printer, as there may be ink on the connection.

 **NOTE:** Avoid storing partially used ink cartridges.

5. The front-panel display identifies the missing ink cartridge.

Insert an ink cartridge

1. Before removing the cartridge from its wrapping, shake it vigorously.

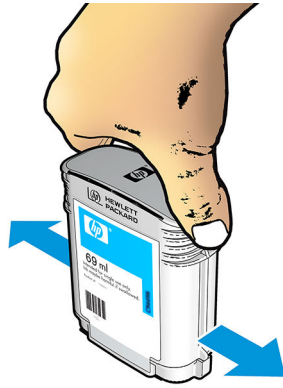

2. Unwrap the new ink cartridge, find the label identifying the ink color. Check that the letter or letters (in these illustrations, M for magenta) marking the empty slot, matches the letter or letters on the cartridge label.
3. Insert the ink cartridge into its slot: photo black, gray, and matte black on the left; cyan, magenta, and yellow on the right.

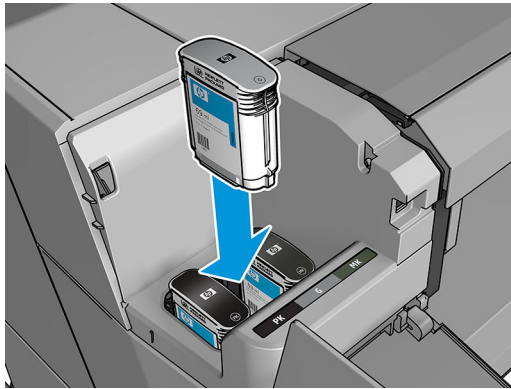

4. Push the cartridge into the slot until it snaps into position. You should hear a beep and see confirmation that the cartridge has been inserted.

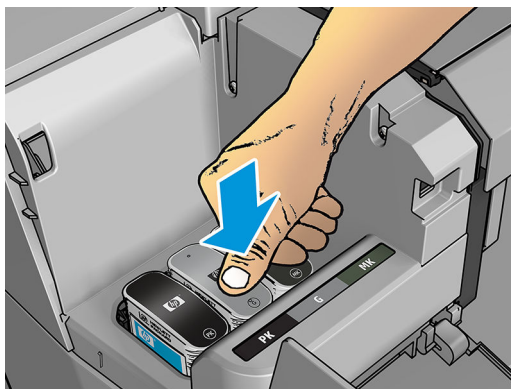

If you have difficulty, see [Cannot insert an ink cartridge on page 227](#).

5. When all cartridges have been inserted, close the cover.

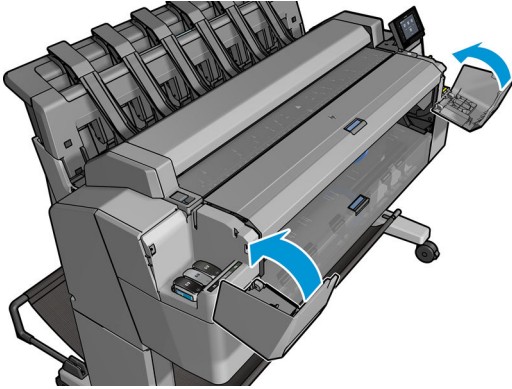

6. The front-panel display confirms that all cartridges have been correctly inserted.

Although it is possible to use non-HP ink cartridges, this choice has several serious disadvantages. It may not be possible to determine with enough accuracy the ink level or status of used, refilled, or counterfeit ink cartridges. Any service or repair required as a result is not covered under the warranty. System ink flushing, color calibration, and printhead alignment are recommended. If you experience print-quality problems, HP recommends changing to Original HP inks.

Safe mode

Under certain conditions, including printer operation outside of environmental specifications, and when a used, refilled, or counterfeit ink cartridge has been detected, the printer will operate in 'safe' mode. HP is unable to warrant the performance of the printing system when operated outside of environmental specifications or when a used, refilled, or counterfeit ink cartridge is installed. Safe mode is designed to protect the printer and the printheads from damage due to unexpected conditions, and is in operation when the  icon is displayed on the printer's front panel and by the Embedded Web Server. For optimal performance, use Original HP ink cartridges. HP DesignJet printing systems, including Original HP inks and printheads, are designed and engineered together to provide uncompromising print quality, consistency, performance, durability, and value—with every print.



About the printhead

The printhead is connected to the ink cartridges and jets ink onto the paper.

 **CAUTION:** Observe precautions when handling the printhead because it is an ESD-sensitive device (see the [Glossary on page 250](#)). Avoid touching pins, leads, and circuitry.

Check the printhead status

The printer automatically checks and services the printhead after each print. Follow the steps below to get more information on your printhead.

1. From the front panel, press  then .
2. The front panel displays:

- Colors
- Product name
- Product number
- Serial number
- Status, see [Front-panel error messages on page 236](#)
- Volume of ink it has used
- Warranty status

You can also get some of this information from the HP Utility.

For an explanation of the printhead status messages, see [Printhead status messages on page 229](#).

If the warranty status is **See warranty note**, this indicates that expired ink is being used. If the warranty status is **Out of warranty**, this indicates that non-HP ink is being used. See the limited warranty document provided with your printer for details of the warranty implications.

Remove the printhead

CAUTION: Make sure the printer wheels are locked (the brake lever is pressed down) to prevent the printer from moving.

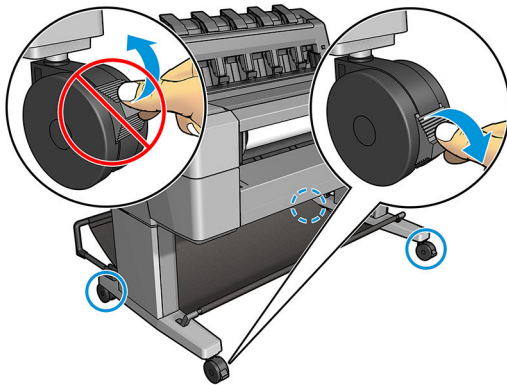

CAUTION: Printhead replacement must be performed with the printer powered on.

1. From the front panel, press , then , then **Replace printhead**.

Alternatively, press , then , then **Ink > Replace printhead**.

The front panel may ask whether the replacement printhead is new or used.

NOTE: You can cancel the process at any time by pressing .

2. The carriage moves automatically to the left side of the printer.

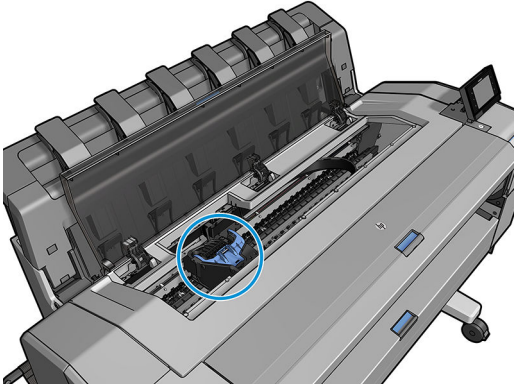

⚠ CAUTION: If the carriage is left in the removal position for more than three minutes without inserting or removing the printhead, it tries to move back to its normal position in the right-hand end.

3. The front panel asks you to lift the scanner.

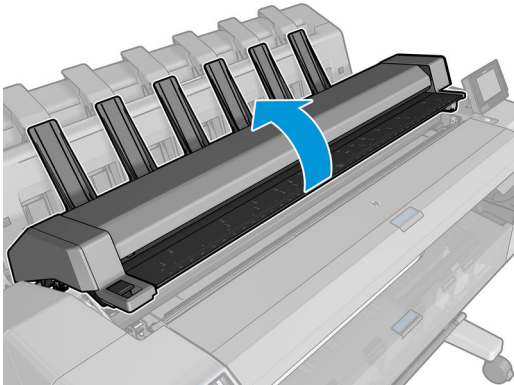
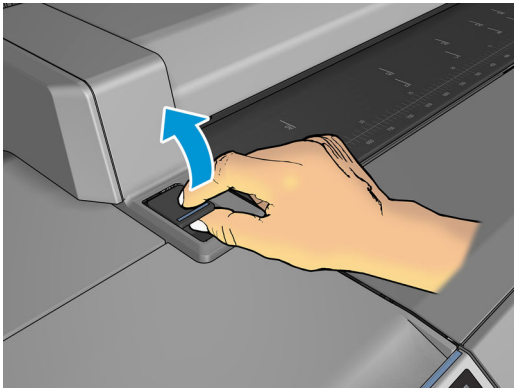

4. Locate the printhead carriage.

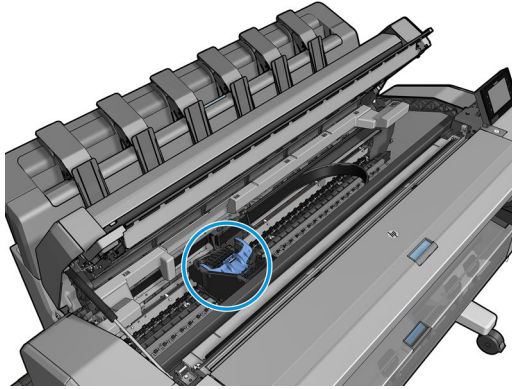

5. Raise the blue printhead cover.

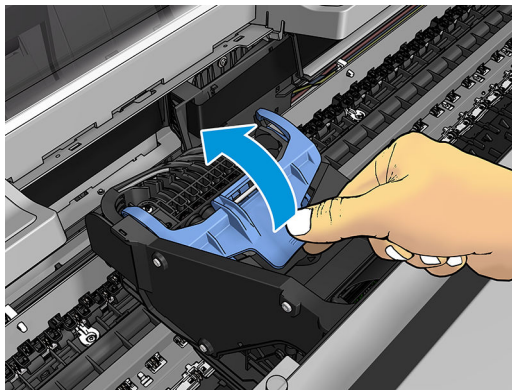

6. Pull the blue cover back towards you, raising the black piece to which it is attached.

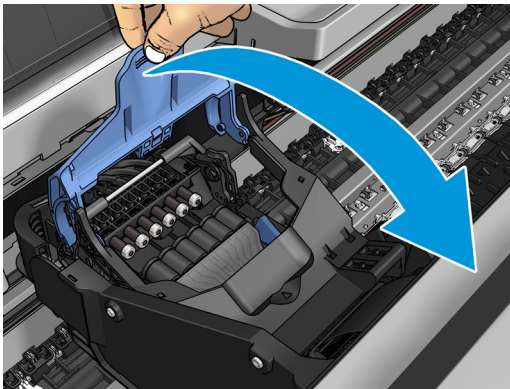
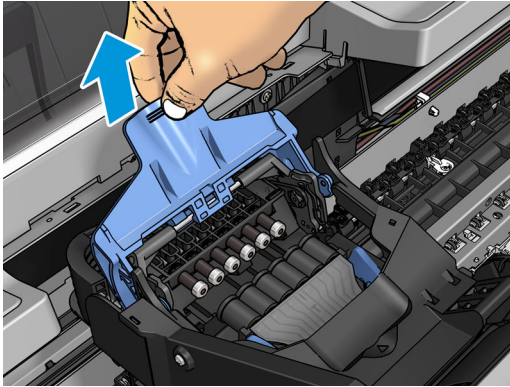

7. Leave the black piece approximately vertical.

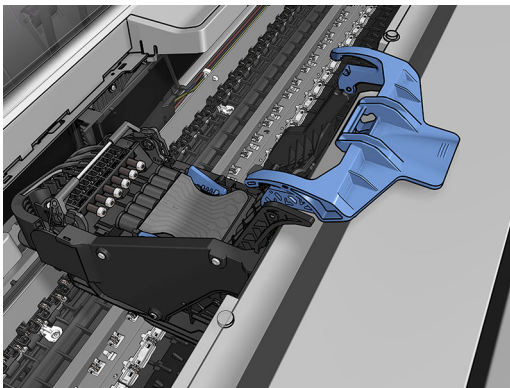

8. Grasp the printhead by the blue pieces on each side.

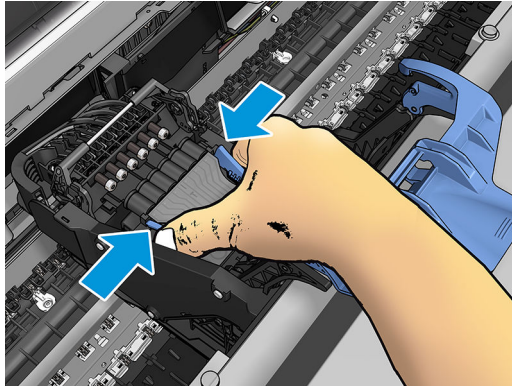

9. Lift the printhead out of the carriage.

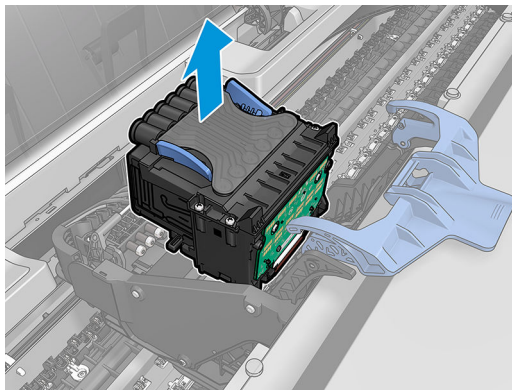

Insert the printhead

 **NOTE:** You cannot insert a new printhead successfully if a connected ink cartridge has not enough ink to complete the printhead replacement process. In this case, you should replace the ink cartridge before inserting the new printhead. You can use the old cartridge later if it still contains some ink.

1. Insert the new printhead.

 **CAUTION:** Insert the printhead slowly and vertically, straight down. It may be damaged if you insert it too fast, or at an angle, or if you rotate it as you insert it.

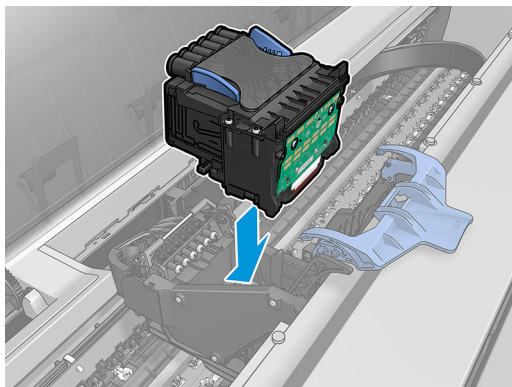

2. Check that the printhead is correctly aligned with its ink connectors.

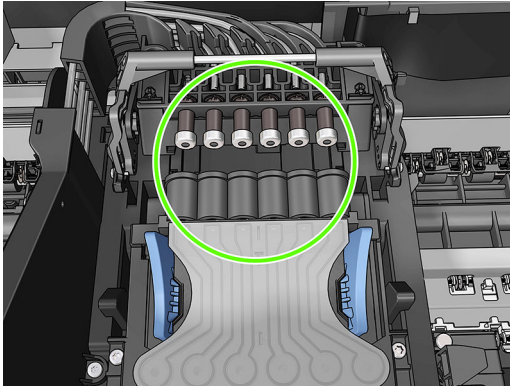

3. Lower the black piece over the printhead.

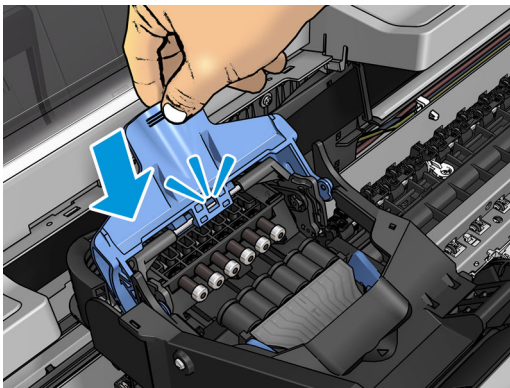
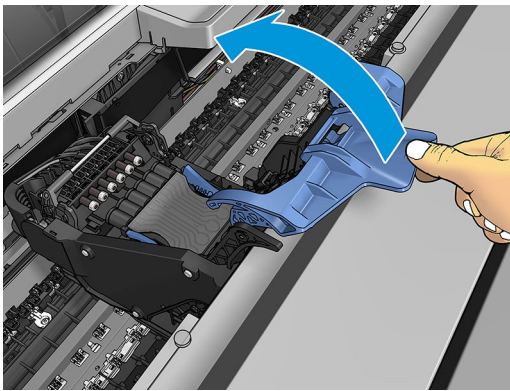

4. Close the blue cover and make sure that it is properly closed.

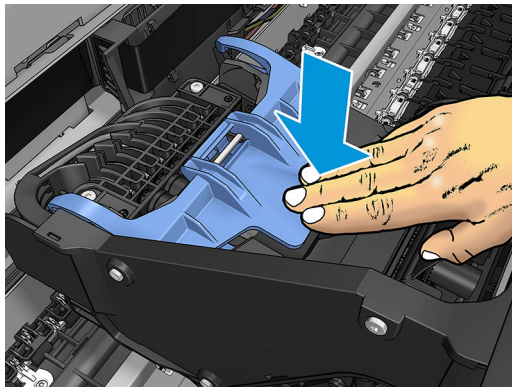
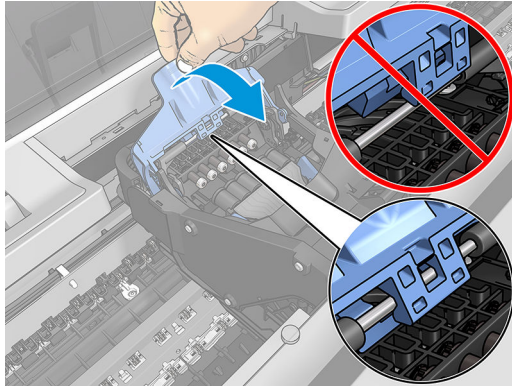

When the printhead has been inserted correctly and is accepted by the printer, the printer beeps.

 **NOTE:** If the printer does not beep when you insert the printhead and the **Replace** message appears on the front-panel display, the printhead may need to be reinserted.

5. Lower the scanner.

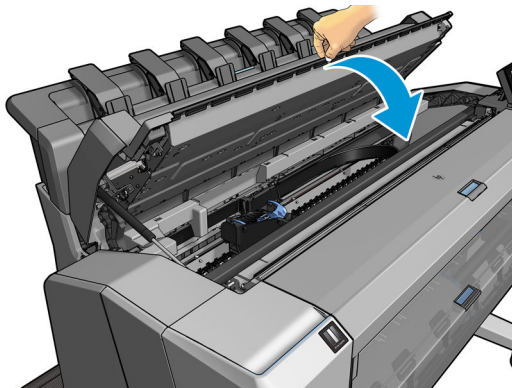

6. The front-panel display confirms that the printhead is correctly inserted. The printer starts checking and preparing the printhead. The default routine process takes 10 minutes. If the printer finds problems in preparing the printhead, it takes longer, up to 45 minutes. After the printhead is checked and prepared, the printhead realignment procedure runs automatically if paper is loaded, see [Align the printhead on page 228](#).
7. You are recommended to perform a color calibration after inserting a new printhead. See [Color calibration on page 104](#).

Storage of anonymous usage information

Each ink cartridge contains a memory chip that assists in the operation of the printer. In addition, this memory chip stores a limited set of anonymous information about the usage of the printer, which can include the following: the date when the cartridge was first installed, the date when the cartridge was last used, the number of prints printed using the cartridge, the print coverage, the frequency of printing, the printing modes used, any printing errors that may have occurred, and the product model. This information helps HP to design future products to meet our customers' printing needs.

The information collected by the memory chip does not include information that could be used to identify a customer or user of the cartridge or printer.

HP collects a sample of the memory chips from ink cartridges returned to HP's free return and recycling program (HP Planet Partners: <http://www.hp.com/hpinfo/globalcitizenship/environment/recycle/>). The sampled memory chips are read and studied in order to improve future HP products.

HP partners who assist in recycling ink cartridges may also have access to the information. Any third party possessing the cartridge may be able to access the anonymous information on the memory chip. If you prefer not to allow access to this information, you can render the chip inoperable. However, after you render the memory chip inoperable, the cartridge cannot be used in an HP printer.

If you are concerned about providing this anonymous information, you can tell the printer not to store the information in the memory chip. To do so, access the Embedded Web Server, and select **Setup > Anonymous Usage Information Storage**. This does not prevent the cartridge from working normally in other respects. However, if you change your mind later, you can restore the factory defaults to resume collecting printer usage information.



17 Printer maintenance

- [Check printer status](#)
- [Clean the exterior of the printer](#)
- [Maintain the ink cartridges](#)
- [Move or store the printer](#)
- [Update the firmware](#)
- [Update the software](#)
- [Printer maintenance kits](#)
- [Secure File Erase](#)
- [Disk Wipe](#)

Check printer status

You can check the current status of the printer in various ways:

- If you start the HP Utility and select your printer, you see a page of information describing the status of the printer and its paper and ink supplies.
- If you access the Embedded Web Server, you see information about the general status of the printer. The Supplies page in the **Main** tab describes the status of the paper and ink supplies.
- At the front panel, you can press  for information about paper, ink levels, ink cartridges, and printhead. If there is a current problem, you are taken automatically to the area with the most urgent problem.

If there are any current alerts, the upper row of the home screen shows the top-priority alert. Press the alert message to see the tab in which this alert is shown and the problem can be solved. Press  and  to see the list of alerts.

Clean the exterior of the printer

Clean the outside of the printer and all other parts of the printer that you regularly touch as part of normal operation with a damp sponge or a soft cloth and a mild household cleaner such as non-abrasive liquid soap.

 **WARNING!** To avoid an electric shock, make sure that the printer is turned off and unplugged before you clean it. Do not let water get inside the printer.

 **CAUTION:** Do not use abrasive cleaners on the printer.

Maintain the ink cartridges

During the normal lifetime of a cartridge, no specific maintenance is required. However, in order to maintain the best print quality, replace a cartridge when it reaches its expiration date. The printer's front panel notifies you when any cartridge reaches its expiration date.

You can also check a cartridge's expiration date at any time: see [Check printer status on page 150](#).

See also [Handling ink cartridges and printhead on page 136](#).

Move or store the printer

If you need to move or store the printer, prepare it correctly to avoid possible damage to it. To prepare the printer, follow the instructions below.

1. Do not remove the ink cartridges or printhead.
2. Make sure that no paper is loaded.
3. Make sure that the printer is idle.
4. Disconnect any cables connecting the printer to a network or a computer.
5. If the stacker seems likely to impede the movement of the printer through doorways, you can fold it out of the way by removing two screws.

If you need to leave the printer turned off for a long time, follow the additional steps below.

1. Turn off the power using the **Power** key on the front panel.
2. Also turn off the power switch at the rear of the printer.
3. Disconnect the printer's power cable.

 **CAUTION:** If you turn the printer upside down, ink could escape into the printer and cause serious damage.

When reconnecting the power cable, remember to route the cable tidily along the back gutter.

When the printer is turned back on, it takes about three minutes to initialize itself and to check and prepare the printhead. Preparing the printhead normally takes just over a minute. However, if the printer has been off for a six weeks or more, preparing the printhead could take up to 45 minutes.

 **CAUTION:** If the printer remains off for a long period of time, the printhead may become unusable. In this case, you need to replace the printhead.

 **TIP:** Because preparing and purging the printhead uses both time and ink, you are strongly recommended to leave the printer always on or in sleep mode, whenever possible, to maintain the health of the printhead. In both cases, the printer wakes up from time to time to maintain the printhead. Thus, you can avoid going through lengthy preparation processes before using your printer.

Update the firmware

The printer's various functions are controlled by firmware that resides in the printer.

From time to time firmware updates will be available from HP. These updates increase the printer's functionality, enhance its features, and may correct minor problems.

 **IMPORTANT:** You are strongly recommended to update the firmware periodically in order to take advantage of the latest developments.

There are various ways of downloading and installing firmware updates; you can choose whichever you find most convenient. They can be divided into two categories: automatic and manual updates.

 **NOTE:** The firmware includes a set of the most commonly used paper presets. Extra paper presets can be downloaded separately; see [Paper presets on page 64](#).

Automatic firmware updates

Automatic firmware updates are a convenience that is possible with Web-connected printers. Your printer can automatically download the latest firmware release and install it for you.

Important notes

- Your printer must be connected to the Internet; see [Set up web services on page 21](#).
- To configure automatic firmware updates, you can use the front panel or the Embedded Web Server; see [Set up web services on page 21](#).
- If an administrator password has been set, it will be required to change these settings.

- A firmware update package can be large; you may want to consider whether there are any implications for your network or Internet connection.
- A firmware update is downloaded in the background: the printer can be printing at the same time. However, it cannot be installed in the background: printing must stop.

Manual firmware updates

Manual firmware updates can be performed in the following ways:

- Using the Embedded Web Server, select the **Setup** tab and then **Maintenance > Firmware update**. Press **Check now** to check whether new firmware is available. If new firmware is available, some information about the new firmware is displayed, and you are given the opportunity to download and install it.
- Using the HP DesignJet Utility under Windows, select the **Admin** tab and then **Firmware Update**.
- Using the HP Utility under Mac OS X, select **Firmware Update** in the Information and Support group.
- Using HP Web Jetadmin, with which you can make manual firmware updates or request automatic updates.
- Using a USB flash drive. Download the firmware file from <http://www.hp.com/go/T2500/firmware> (according to your printer model) into the USB flash drive and insert it into the Hi-Speed USB host port in the front panel. A firmware update assistant will appear on the front panel to guide you through the update process.

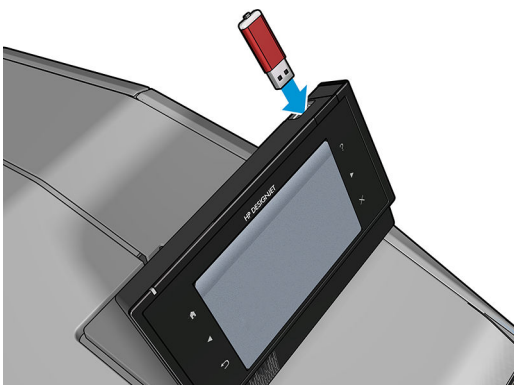

Update the software

To update printer drivers and other software for your printer, go to <http://www.hp.com/go/T2500/drivers>.

- Under Windows, HP Software Update regularly offers to update your software automatically, and the HP DesignJet Utility may offer you automatic updates when restarted.
- Under Mac OS X, Apple SW Update offers you software updates when available.

Printer maintenance kits

Two maintenance kits are available for your printer, containing components that may need to be replaced after long use. When one of them is needed, a message is displayed on the front panel and by the HP Utility.

When you see the message, you should contact HP Support (see [Contact HP Support on page 243](#)) and request the maintenance kit. The kits are installed by service engineers only.

Secure File Erase

The printer's hard disk is used as a temporary storage area for print jobs. Secure File Erase can erase your temporary files from the hard disk to protect them from unauthorized access. It begins to do so as soon as you turn it on, but old temporary files that were already on the hard disk are not erased retroactively. If you want to erase the old files too, see [Disk Wipe on page 153](#).

Secure File Erase provides three different levels of security:

- **Non-Secure:** all pointers to the information are erased. The information itself remains on the hard disk until the disk space it occupies is needed for other purposes, and it is then overwritten. While it remains on the disk, it is difficult for most people to access, but may be accessed using software designed for the purpose. This is the normal method in which files are erased on most computer systems; it is the fastest method but the least secure.
- **Secure Fast Erase (1 pass):** all pointers to the information are erased, and the information itself is also overwritten with a fixed character pattern. This method is slower than Non-Secure, but more secure. It may still be possible to access fragments of the erased information by using special tools to detect residual magnetic traces.
- **Secure Sanitizing Erase (5 passes):** all pointers to the information are erased, and the information itself is repetitively overwritten using an algorithm designed to eliminate any residual traces. This is the slowest method, but the most secure. Secure Sanitizing Erase meets the US Department of Defense 5220-22.m requirements for clearing and sanitization of disk media. This is the default security level when using Secure File Erase.

While files are being erased, the printer's performance may be affected.

Secure File Erase is one of the facilities provided by Web JetAdmin, which is HP's free Web-based print management software: see <http://www.hp.com/go/webjetadmin>.

If you have difficulty in using Secure File Erase from Web JetAdmin, please contact HP Support: see [Contact HP Support on page 243](#).

The Secure File Erase configuration can be changed from Web JetAdmin or the Embedded Web Server (**Setup > Security**).

Disk Wipe

Disk Wipe is the same as Secure File Erase (see [Secure File Erase on page 153](#)), except that it erases all temporary files, including old ones.

The Disk Wipe configuration can be changed from Web JetAdmin or the Embedded Web Server (**Setup > Security**).



NOTE: If you choose to erase the whole hard disk, you may be asked to restart the printer several times during the process, which will take about 6 hours with Secure Fast Erase or 24 hours with Secure Sanitizing Erase.

18 Scanner maintenance

- [Clean the scanner's glass plate](#)
- [Replace the scanner's glass plate](#)
- [Calibrate the scanner](#)

Clean the scanner's glass plate

You are recommended to clean the scanner's glass plate periodically, depending on how often you use the scanner.

1. Turn off the printer using the **Power** key at the front, then also turn off the power switch at the rear and disconnect the power cable.
2. There is a small lever at the rear left of the scanner. Slide the lever up and open the scanner cover.

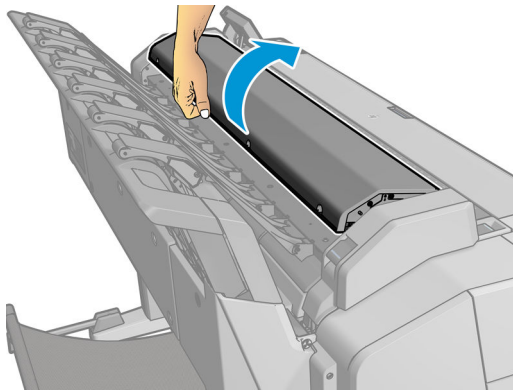
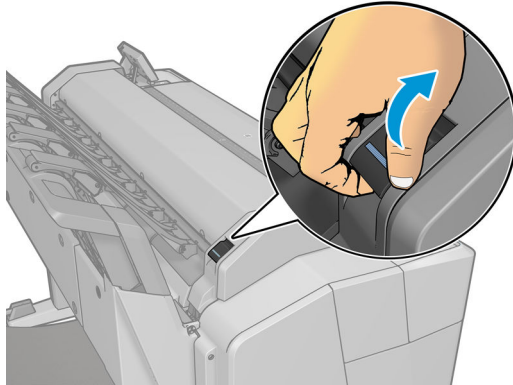

⚠ WARNING! Do not lift the scanner while the scanner cover is open. Your fingers or hand may be trapped or crushed.

3. Gently wipe the glass plate and the surrounding area with a lint-free cloth dampened with water and then wrung dry. A suitable cloth is provided with the printer.

⚠ CAUTION: Do not use abrasives, acetone, benzene or fluids that contain these chemicals. Do not spray liquids directly onto the scanner glass plate or anywhere else in the scanner.

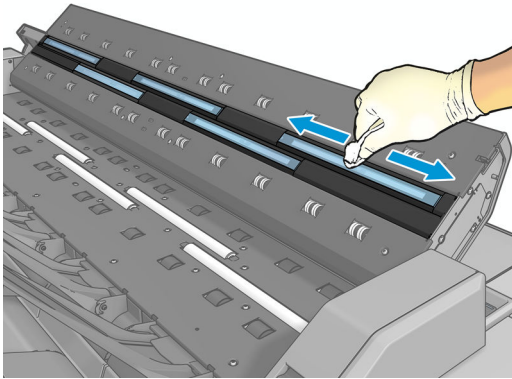

Do not worry about tiny droplets of water left on the glass: they will evaporate.

4. Optionally, for more thorough cleaning:
 - Remove the glass plate and clean it on both sides. See [Replace the scanner's glass plate on page 158](#).

- Clean the pressure rollers and the feed rollers.

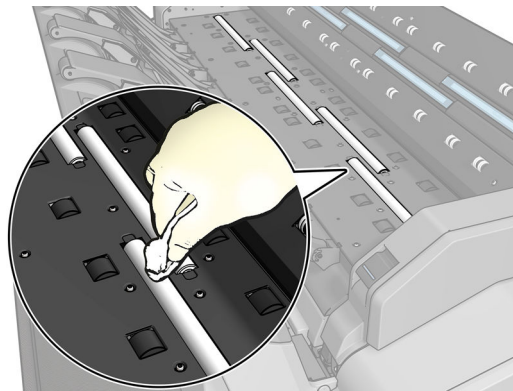
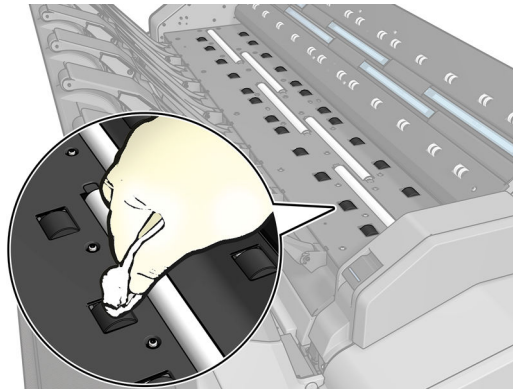
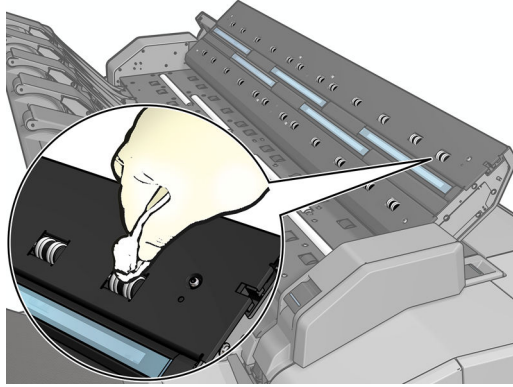

5. Close the scanner cover and gently push it down to lock it into place.

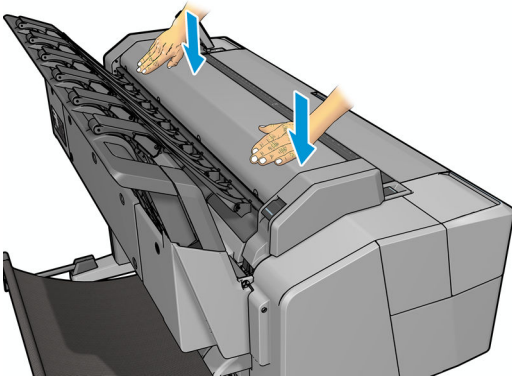
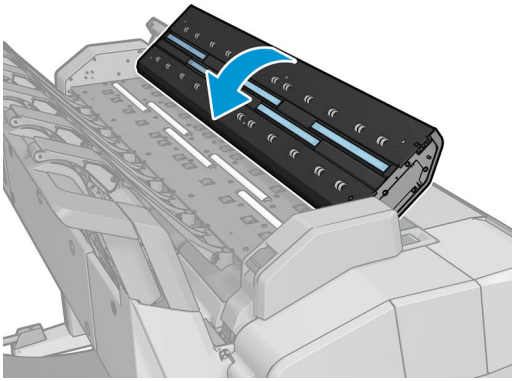

6. Clean the area immediately in front of the scanner, where the scanned sheet rests before scanning.
7. Reconnect the printer's power cable, turn on the power switch at the rear, and turn on the printer using the **Power** key.

Replace the scanner's glass plate

Over time, the condition of the glass plate can deteriorate. Small scratches on the surface of the glass can reduce image quality. Contact HP Support (see [Contact HP Support on page 243](#)) to order a new glass plate.

1. Turn off the printer using the **Power** key at the front, then also turn off the power switch at the rear and disconnect the power cable.

2. There is a small lever at the rear left of the scanner. Slide the lever up and open the scanner cover.

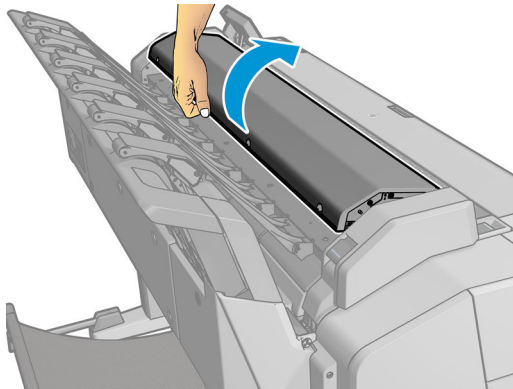
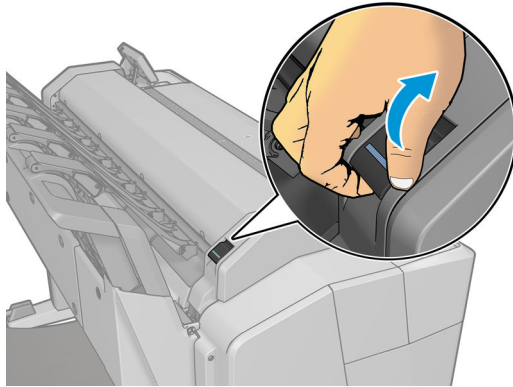

⚠ WARNING! Do not lift the scanner while the scanner cover is open. Your fingers or hand may be trapped or crushed.

3. Unscrew 4 screws from the upper part if you intend to replace any of the three upper glasses; or unscrew the 4 screws of the lower part for the two lower glasses.

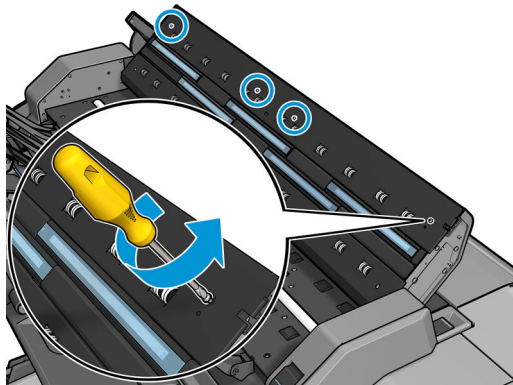

4. Remove the plastic piece (upper or lower as appropriate), and the plastic tabs next to the glass you intend to remove.

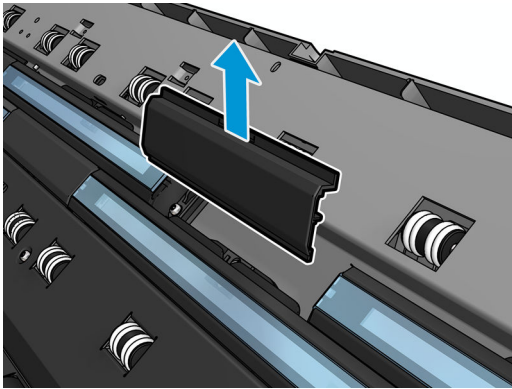
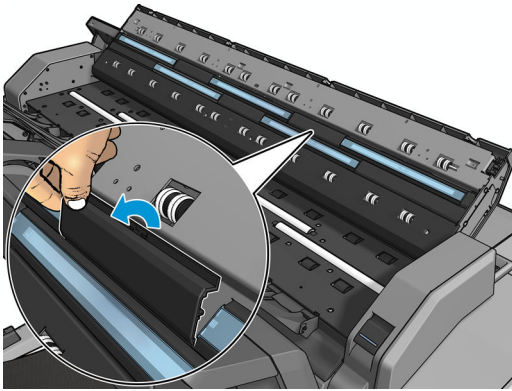
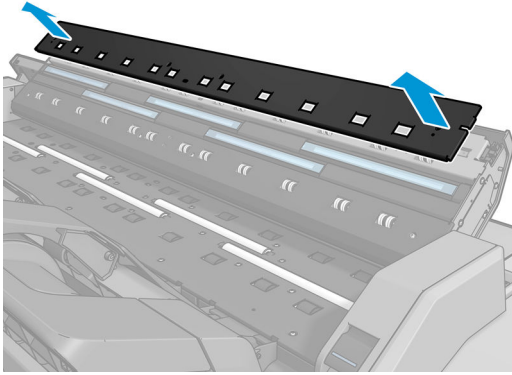

5. Slide the glass laterally to remove it.

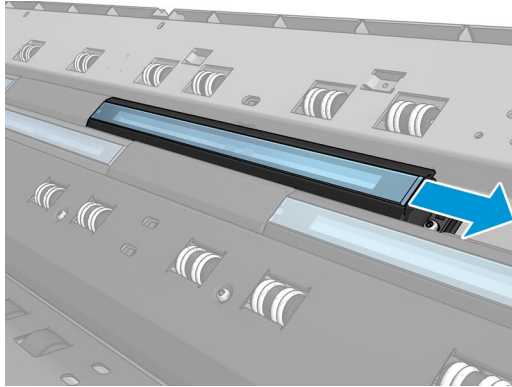

6. Slide the new glass into place.

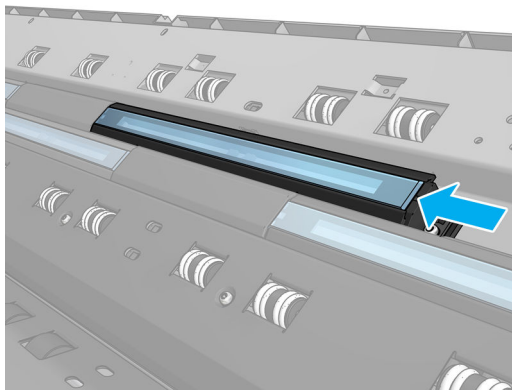

7. Put back the plastic tabs you removed earlier.

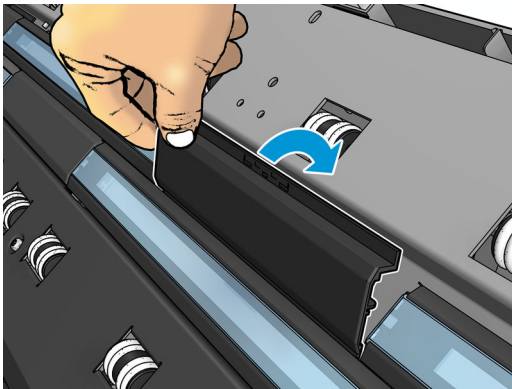
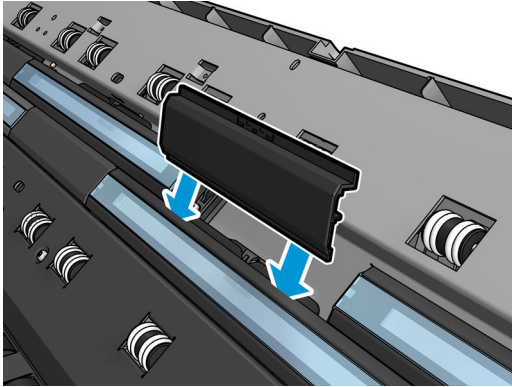

8. Put back and screw in the plastic piece you removed earlier.

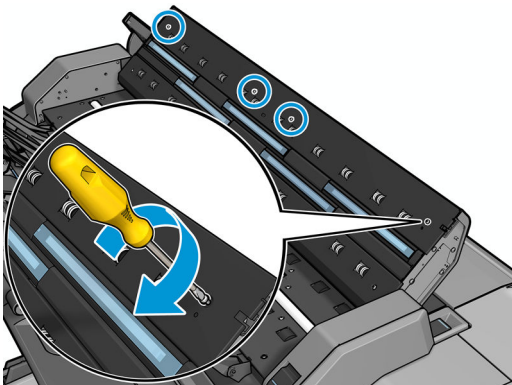
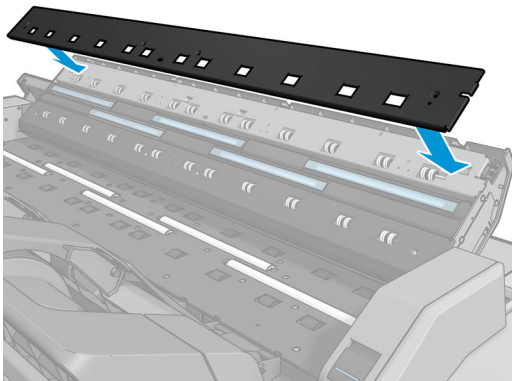

9. Close the scanner cover and gently push it down to lock it into place.

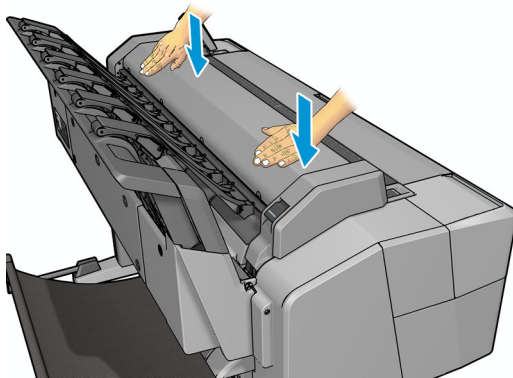
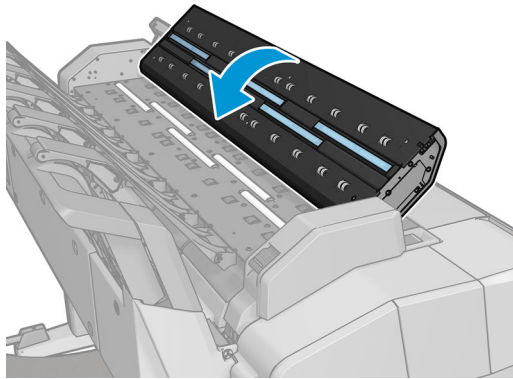



10. Reconnect the printer's power cable, turn on the power switch at the rear, and turn on the printer using the **Power** key.

Calibrate the scanner

Your scanner has been calibrated at the factory, and theoretically CIS scanners do not need to be recalibrated during their lifetimes. Nevertheless, because of environmental changes, your scanner may start showing image defects that can be easily corrected by recalibrating the scanner. The whole procedure takes less than 10 minutes, and you are recommended to recalibrate the scanner whenever you see some undesired artifact or a lack of quality in scanned files or copies, bearing in mind the limitations of CIS technology already explained in this guide. If you perform calibration successfully and still have concerns about the image quality, please read [Troubleshooting scan-quality issues on page 200](#) in order to detect whether you are facing a product limitation, and may want to consider buying a CCD scanner.

To calibrate the scanner

1. Clean the scanner. See [Clean the scanner's glass plate on page 155](#).
2. Go to the front panel and press , then , then **Image Quality Maintenance > Calibrate scanner**.
3. Follow the instructions in the front panel.

The supplied maintenance sheet required to perform scanner calibration looks like this:



Load the maintenance sheet into the scanner face up, centered and with as little skew as possible. Once the calibration is finished, the maintenance sheet should be carefully placed into its solid cover, and saved in a fresh and dry place. Otherwise, it could be damaged, which could affect the operation of your scanner in the future. Check that the maintenance sheet is not dirty, wrinkled, scratched or folded before calibrating the scanner. If necessary, call HP support and ask for a new maintenance sheet.

If calibration fails

1. Ensure that the printer is turned on and ready for normal operation.
2. Ensure that the scanner is working correctly. To test it, scan a small document to file.
3. Ensure that the scanner is clean before calibration. If in doubt, clean the scanner and restart the calibration process.
4. Eject and reload the calibration sheet, checking that it is clean, in good condition, face up and perfectly centered in the scanner.
5. If the above steps do not help, eject the sheet and restart the printer (turn off and on). When the system has restarted, repeat the calibration.
6. If you cannot perform the calibration successfully in three consecutive attempts, call HP support and report the error code that appears in the front panel.

19 Supplies and accessories

- [How to order supplies and accessories](#)
- [Introduction to the accessories](#)

How to order supplies and accessories

There are two alternative ways to order supplies or accessories:

- Visit <http://www.hp.com>, select your printer and click on the accessories button.
- Contact HP Support (see [Contact HP Support on page 243](#)), and check that what you want is available in your area.

The rest of this chapter lists the available supplies and accessories, and their part numbers, at the time of writing.

Order ink supplies

The following ink supplies can be ordered for your printer.

Table 19-1 Ink cartridges

Cartridge	Part number
HP 727 40-ml Cyan DesignJet Ink Cartridge	B3P13A
HP 727 40-ml Magenta DesignJet Ink Cartridge	B3P14A
HP 727 40-ml Yellow DesignJet Ink Cartridge	B3P15A
HP 727 40-ml Photo Black DesignJet Ink Cartridge	B3P17A
HP 727 40-ml Gray DesignJet Ink Cartridge	B3P18A
HP 727 69-ml Matte Black DesignJet Ink Cartridge	C1Q11A
HP 727 130-ml Cyan DesignJet Ink Cartridge	B3P19A
HP 727 130-ml Magenta DesignJet Ink Cartridge	B3P20A
HP 727 130-ml Yellow DesignJet Ink Cartridge	B3P21A
HP 727 130-ml Matte Black DesignJet Ink Cartridge	B3P22A
HP 727 130-ml Photo Black DesignJet Ink Cartridge	B3P23A
HP 727 130-ml Gray DesignJet Ink Cartridge	B3P24A
HP 727 300-ml Matte Black DesignJet Ink Cartridge	C1Q12A

Table 19-2 Printhead

Printhead	Part number
HP 727 Printhead	B3P06A

Order paper

Your printer can use a wide range of paper, check last information related to papers supported by your printer at www.hpmedia.com

Order accessories

The following accessories can be ordered for your printer.

Name	Product number
HP DesignJet PostScript®/Pdf Upgrade Kit	C0C66A
HP DesignJet 3-in Spindle Adaptor Kit	CN538A
HP DesignJet 36-in Spindle	L4R66A
HP HD Pro 42-in scanner	G6H51B
HP SD Pro 44-in scanner	G6H50B

Introduction to the accessories

PostScript Upgrade

The PostScript Upgrade enables a T2500 to print the same file types that a T2500 PS can print, including PDF and PostScript files. The PostScript upgrade can be plugged into the printer's USB host. It is not necessary to leave it permanently connected: just plug it in once, and the printer is upgraded forever.

Spindle

With extra spindles, you can change rapidly from one paper type to another.

3-in Spindle Adaptor Kit

With this adaptor you can use paper rolls with 3-inch cores, provided that the diameter of the roll is within printer specifications.

20 Troubleshooting paper issues

- [The paper cannot be loaded successfully](#)
- [The paper type is not in the list](#)
- [The printer printed on the wrong paper type](#)
- [An “on hold for paper” message](#)
- [The paper has jammed in the print platen](#)
- [The paper has jammed in the stacker](#)
- [The printer reports unexpectedly that the stacker is full](#)
- [The printer displays out of paper when paper is available](#)
- [Prints do not fall neatly into the basket](#)
- [The print remains in the printer after printing has completed](#)
- [The cutter does not cut well](#)
- [The roll is loose on the spindle](#)

The paper cannot be loaded successfully

- Ensure no paper is loaded.
- Ensure the paper is far enough inside the printer, you should feel the printer grab the paper.
- The paper may be crumpled, or warped, or may have irregular edges.

Unsuccessful roll load

- If the paper does not load, the leading edge of the paper may not be straight or clean and needs to be trimmed. Remove the initial 2 cm (1 in) from the roll and try again. This may be necessary even with a new roll of paper.
- Check that the spindle is correctly inserted.
- Check that the paper is correctly loaded on the spindle, and that it loads over the roll towards the stacker.
- Check that all roll end plugs have been removed.
- Check that the paper is wound tightly on the roll.
- Do not touch the roll or paper during the alignment process.
- When loading a roll, the roll cover must remain open until the front panel prompts you to close it.
- If the roll is not aligned, the front panel displays an error and instructions to start again. To start the load process again, cancel the process on the front panel and rewind the roll from the end of the spindle until the edge is removed from the printer.



NOTE: If the roll has become loose around the core, the printer cannot load the paper.

Unsuccessful sheet load

- Keep pushing the sheet until you feel resistance. Do not release the sheet until the printer starts to pull the paper and you hear a beep.
- Guide the sheet, especially thick papers, when the printer initially feeds the sheet.
- Ensure that the sheet is aligned with the reference line on the roll cover.
- Do not attempt to straighten the sheet during the loading process, unless instructed to by the front-panel display.
- Do not use hand-cut sheets, which may be of irregular shapes. Use only purchased sheets.

In case of any problem, please follow the instructions given on the front-panel display.

If you would like to start the load process again, cancel the process on the front panel. If a sheet is in the printer, it is ejected to the stacker.

Paper loading error messages

Here is a list of front-panel messages related to paper loading, with the suggested corrective action.

Front-panel message	Suggested action
Close the roll cover when the paper load is finished	Close the roll cover when the paper load is finished.
Paper not detected	During the paper load process the printer did not detect any paper. Ensure the paper is inserted fully and is not transparent.
Roll cover closed during paper load process	Do not close the roll cover until you are prompted to do so by the front panel.
Sheet too small	During the load process the printer detected that the sheet of paper is too narrow or too short to be loaded in the printer. Press  to stop the load process. See Functional specifications on page 246 .

The paper type is not in the list

To work with a paper that does not appear in the list in the driver or front panel, you can choose one of the other papers in the list. However, you should at least choose a paper of the same type: transparent or translucent, photo or bond, coated or technical.



NOTE: For photo paper, it is important to select a photo paper type, as the printer adjusts its use of ink for photo paper.

Transparent or translucent film

If your paper is a transparent film (for example, a transparency), select paper type **Film > Transparent/Clear film**.

If your paper is a translucent paper or film (for example, technical paper), select paper type **Film > Matte film**.

Photo paper

If your paper is a photo paper, use the **Photo Paper** category. For gloss or high-gloss paper, select paper type **Photo Gloss Paper**. For semi-gloss, satin, pearl, or luster finishes, select paper type **Photo Semi-gloss/Satin Paper**.

To increase gamut on photo paper, select paper type **HP Universal Gloss Photo Paper** or **HP Universal Satin Photo Paper**, depending on the finish.

Bond and coated or technical paper

Your paper type selection for generic paper depends on the paper's ink absorption capacity.

- For thin papers (< 90 g/m²) or uncoated papers (for example plain paper or bright white paper), select paper type **Bond and Coated Paper > Plain Paper**. You can also select **Recycled Bond Paper**.
- For light coated papers (< 110 g/m²), select paper type **Bond and Coated Paper > HP Coated Paper**.
- For heavyweight coated papers (< 200 g/m²), select paper type **Bond and Coated Paper > Heavyweight Coated Paper**.

Black ink is easily removed when touched

This happens when your paper is incompatible with matte black ink. To use an optimized ink combination, select paper type **Photo Paper > Photo Gloss Paper**.

After printing, the paper has wrinkles or there is too much ink

Reduce the quantity of ink, or use thicker paper. Matte paper categories from thinnest to thickest are:

- Plain Paper
- Coated Paper
- Heavyweight Coated Paper
- Super Heavyweight Plus Matte Paper

 **TIP:** If you load paper that is slightly thicker than the paper type you selected, the printer will use less ink than usual for the loaded paper.

For other print-quality problems, see [Troubleshooting print-quality issues on page 179](#).

The printer printed on the wrong paper type

If the printer prints your job before you were able to load your desired paper, you may have **Any** or **Use printer settings** selected for the Paper Type in the printer driver. In this case, the printer will print immediately on whichever paper is loaded. Load your desired paper, see [Paper handling on page 51](#), and select your paper type specifically in the driver.

- **In the Windows driver dialog:** select the **Paper/Quality** tab, then select your paper type from the Paper Type list.
- **In the Mac OS X Print dialog:** select the **Paper/Quality** panel, then select your paper type from the Paper Type list.

 **NOTE:** The driver default is **Any** for Mac OS and **Use printer settings** for Windows; they have the same effect.

An “on hold for paper” message

Based on a set of conditions that you can set when sending a job to the printer (see [Paper mismatch action on page 28](#)), the printer will decide which of the loaded rolls of paper is more suitable to print the job. If there is no roll of paper available that meets all the conditions, the printer will put the job on hold for paper. You can manually resume the job, forcing it to print on a paper other than the one originally specified, otherwise it will stay on hold.

Which criteria are used to decide on which roll a job will be printed?

When a user sends a job, the desired paper type can be set (in the driver or in the Embedded Web Server). The printer will print the job on a roll of paper of the chosen paper type that is large enough to print the drawing without clipping. If there is more than one roll on which the job could be printed meeting all the criteria, the roll will be chosen according to your preferences. These can be set from the front panel: see [Roll switching options on page 29](#).

When is a job put on hold for paper?

If the paper mismatch action is set to **Put job on hold** (see [Paper mismatch action on page 28](#)), a job is put on hold for paper in the following cases:

- The paper type that has been selected by the user is not currently loaded on the specified roll—or on either of the rolls, if no roll has been specified.
- The paper type that has been selected by the user is loaded on the specified roll, but the drawing is too large to fit on the roll—or on either of the rolls, if no roll has been specified.

If I load a new roll of paper, will jobs that were on hold for paper be automatically printed?

Yes. Every time a new roll of paper is loaded, the printer will check if there are any jobs on hold for paper that could be printed on the loaded roll.

I don't like jobs being put on hold for paper. Can I prevent it?

Yes, this can be done from the front panel: see [Paper mismatch action on page 28](#).

I set the option “Paper mismatch action” to “Print anyway”, but some jobs are still put on hold (Windows driver only)

If the **Show print preview** option is selected in the driver or the Embedded Web Server, jobs are put on hold until you have checked the preview and resumed the job. Check that the **Show print preview** option is not checked in the driver, and that there are no pending preview windows waiting for confirmation to continue printing.

My job is exactly as wide as the roll of paper that is loaded on the printer, but is put on hold for paper

Margins are managed in different ways depending on the file type:

- For HP-GL/2 and HP RTL files, by default, margins are included inside the drawing, so a 914 mm (36 in) HP-GL/2 and HP RTL file can be printed on a 914 mm (36 in) roll of paper and will not be put on hold for paper.
- For other file formats, such as PostScript, PDF, TIFF or JPEG, the printer assumes that margins need to be added outside the drawing (as, in many cases, these formats are used for photographs and other images that do not include margins). This means that, to print a 914 mm (36 in) TIFF, the printer needs to add margins, and the drawing needs 925 mm (36.4 in) of paper to be printed; this would cause the job to be put on hold if the paper that is loaded on the printer is only 914 mm (36 in) wide.

If you wish to print these file formats without adding extra margins outside of the drawing, the **Clip contents by margins** option can be used. This option will force the margins to be set inside of the drawing, so a 914 mm (36 in) TIFF can be printed on a 914 mm (36 in) roll of paper without being put on hold. However, if there is no white space already included in the drawing's borders, some contents could be clipped because of the margins.



NOTE: If you choose the option **Match exact size**, your job will be printed only on paper whose width exactly matches the width of the job.

The paper has jammed in the print platen

When a paper jam occurs, you normally see the **Possible paper jam** message in the front-panel display, and a system error 81:01 or 86:01.

1. Lift the scanner.

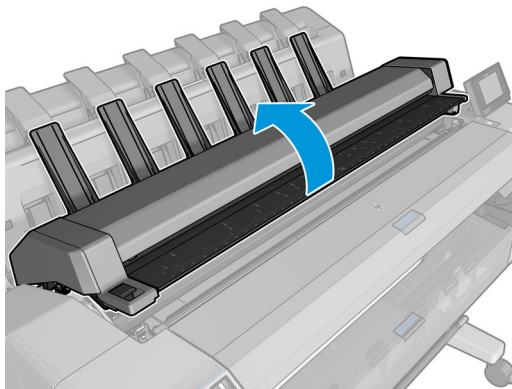
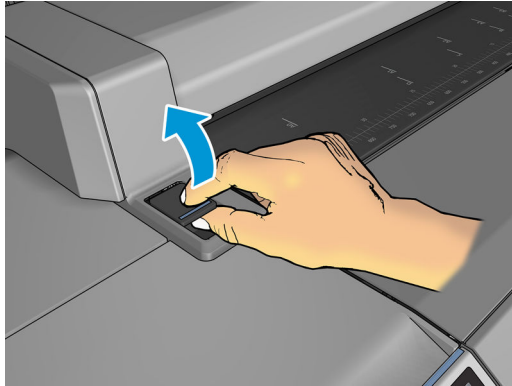

2. Move the carriage manually to the left side of the printer, if feasible.

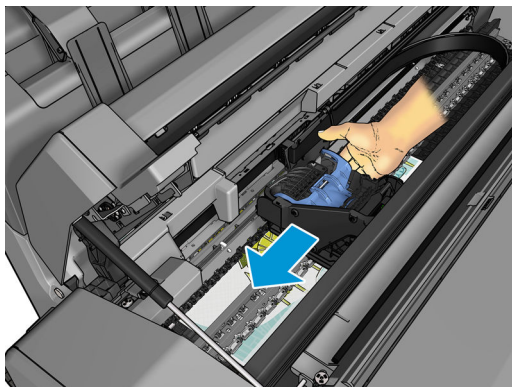

3. Go to the paper path.

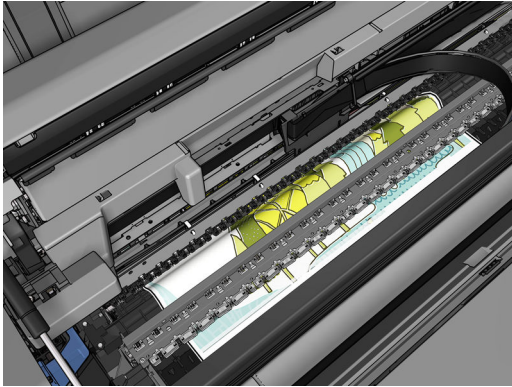

4. Cut the paper with a pair of scissors.

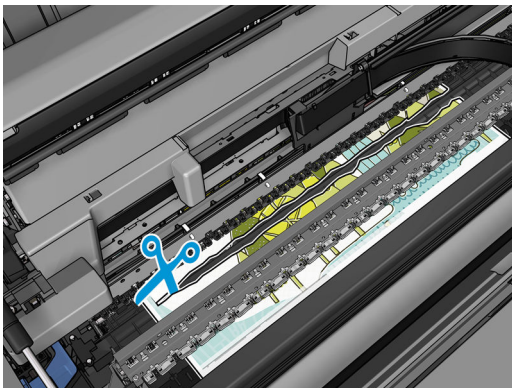
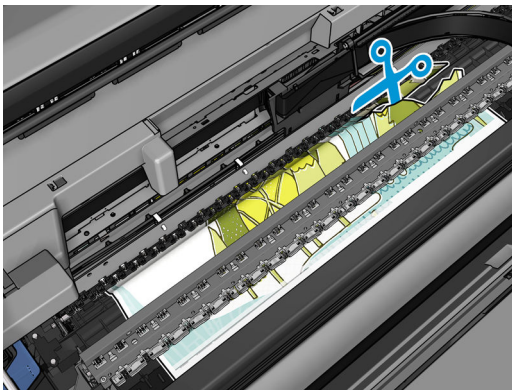

5. Open the roll cover.

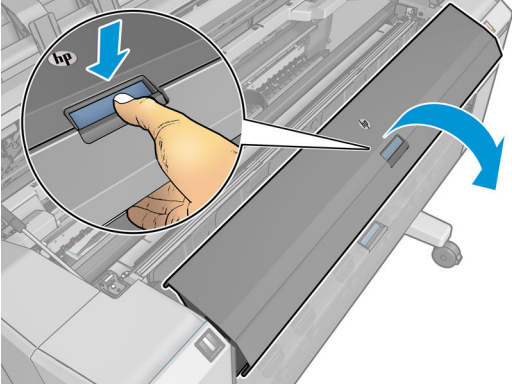

6. Manually rewind paper onto the roll.

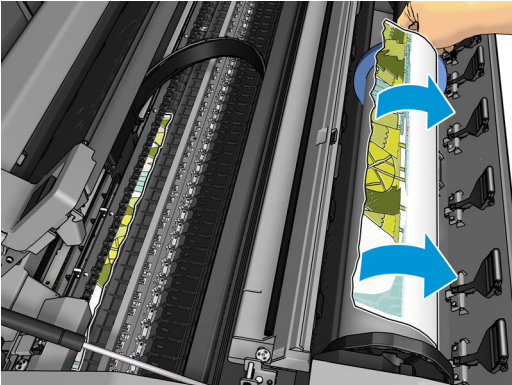
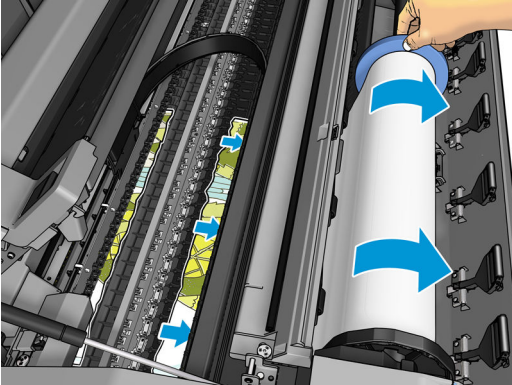
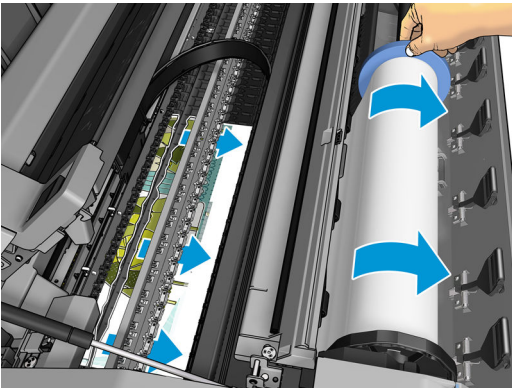

7. If the leading edge of the paper is ragged, trim it carefully with scissors.

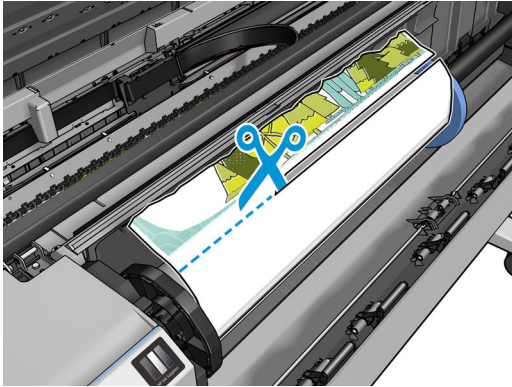

8. Remove the paper left in the printer.

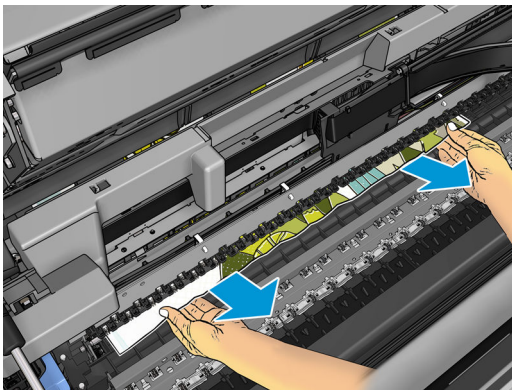

9. Make sure you have removed every fragment of paper.

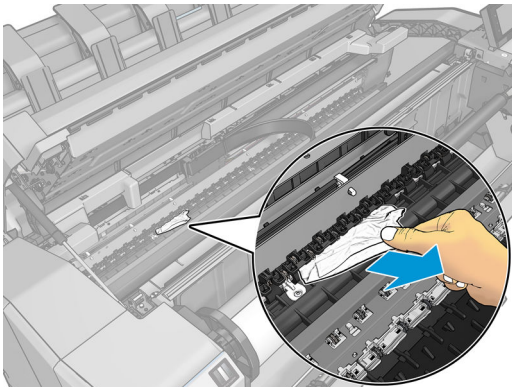

10. Lower the scanner and close the roll cover.

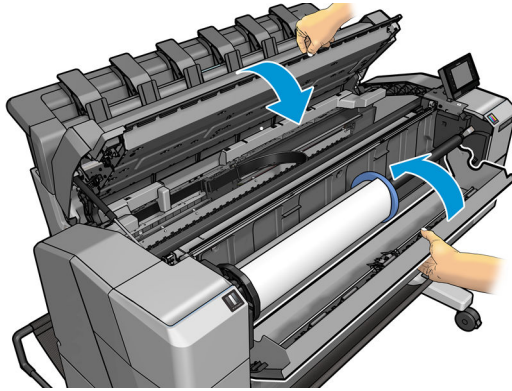

11. Restart the printer by holding down the power button for a few seconds, or by turning the power switch at the rear off and then on.
12. Reload the roll, or load a new sheet see [Paper handling on page 51](#).

 **NOTE:** If you find that there is still some paper causing an obstruction within the printer, restart the procedure and carefully remove all pieces of paper.

The paper has jammed in the stacker

When a paper jam is detected in the stacker, printing is paused, and the front panel asks you to open the stacker cover and clear the jam by pulling out the paper.

When the stacker cover is closed and the printer detects no jammed paper, the front panel requests confirmation to continue printing.

The printer reports unexpectedly that the stacker is full

The printer may report that the stacker is full in the following circumstances:

- When there is a paper jam in the stacker
- When you are using very thin or very stiff paper, such as heavyweight coated paper
- When you are sending small paper sizes to the stacker, such as A3 portrait or A2 landscape

The printer displays out of paper when paper is available

If the roll has become loose from its core, it will not feed correctly and the printer will not load the paper. If possible, tighten the paper to its core or load a new roll.

Prints do not fall neatly into the basket

- Ensure that the network and power cables are not getting in the way.
- Ensure that the basket is correctly installed.
- Ensure that the basket is open.

- Ensure that the basket is not full.
- Ensure that the paper is not jammed.
- Paper often tends to curl near the end of a roll, which can cause output problems. Load a new roll, or remove prints manually as they are completed.

If you see the message **Please remove the print from the basket and press OK to continue**, empty the basket, check that there is no paper in the path to the basket, then press **OK**. The printer checks that the problem has been fixed.

The print remains in the printer after printing has completed

The printer holds the paper to allow the print to dry after printing, see [Change the drying time on page 65](#). If a sheet of paper is only partially ejected after the drying time, gently pull it out of the printer.

The cutter does not cut well

By default, the printer is set to cut the paper automatically after each job.

If the cutter is turned on but not cutting correctly, check that the cutter rail is clean and clear of any obstacles.

The roll is loose on the spindle

The roll may need to be replaced or reloaded.

21 Troubleshooting print-quality issues

- [General advice](#)
- [Print-quality troubleshooting wizard](#)
- [Recalibrate the paper advance](#)
- [Horizontal lines across the image \(banding\)](#)
- [Lines are too thick, too thin or missing](#)
- [Lines appear stepped or jagged](#)
- [Lines print double or in the wrong colors](#)
- [Lines are discontinuous](#)
- [Lines are blurred](#)
- [Line lengths are inaccurate](#)
- [The whole image is blurry or grainy](#)
- [The paper is not flat](#)
- [The print is scuffed or scratched](#)
- [Ink marks on the paper](#)
- [Black ink comes off when you touch the print](#)
- [Edges of objects are stepped or not sharp](#)
- [Edges of objects are darker than expected](#)
- [Horizontal lines at the end of a cut sheet print](#)
- [Vertical bands of different colors](#)
- [White spots on the print](#)
- [Colors are inaccurate](#)
- [Colors are fading](#)
- [The image is incomplete \(clipped at the bottom\)](#)
- [The image is clipped](#)

- [Some objects are missing from the printed image](#)
- [A PDF file is clipped or objects are missing](#)
- [The Image Diagnostics Print](#)
- [If you still have a problem](#)

General advice

When you have any print-quality problem:

- To achieve the best performance from your printer, use only genuine manufacturer's supplies and accessories, whose reliability and performance have been thoroughly tested to give trouble-free performance and best-quality prints. For details of recommended papers, see [Order paper on page 166](#).
- Make sure that the paper type selected in the front panel is the same as the paper type loaded into the printer (see [View information about the paper on page 63](#)). At the same time, check that the paper type has been calibrated. Also make sure that the paper type selected in your software is the same as the paper type loaded into the printer.

CAUTION: If you have the wrong paper type selected, you could experience poor print quality and incorrect colors, and perhaps even damage to the printhead.

- Check that you are using the most appropriate print-quality settings for your purposes (see [Printing on page 69](#)). You are likely to see lower print quality if you have moved the print-quality slider to the 'Speed' end of the scale, or set the custom quality level to **Fast**.
- Check that your environmental conditions (temperature, humidity) are in the recommended range. See [Environmental specifications on page 249](#).
- Check that your ink cartridges and printhead have not passed their expiration dates: see [Maintain the ink cartridges on page 150](#).



For the latest information, please visit <http://www.hp.com/go/T2500/support>.

Print-quality troubleshooting wizard

The print-quality troubleshooting wizard can help with the following problems:

- Horizontal lines across the image (banding)
- The whole image is blurry or grainy
- Lines are too thick, too thin or missing
- Colors are inaccurate

To start the wizard:



- **From the HP DesignJet Utility for Windows:** Go to the **Support** tab, and select **Print Quality Toolbox**.
- **From the HP Utility for Mac OS X:** Select **Print quality troubleshooting** in the Support group.
- **From the Embedded Web Server:** Go to the **Support** tab, then select **Print quality troubleshooting**.
- **From the front panel:** Press , then , then **Image quality maintenance**.

Alternatively, or if you have other print-quality problems, you can continue reading this chapter.

Recalibrate the paper advance



Accurate paper advance is important to image quality because it is part of controlling the proper placement of dots on the paper. If the paper is not advanced the proper distance between printhead passes, light or dark bands appear in the print and image grain may increase.

The printer is calibrated to advance correctly with all the papers appearing in the front panel. When you select the type of loaded paper, the printer adjusts the rate at which to advance the paper while printing. However, if you are not satisfied with the default calibration of your paper, you may need to recalibrate the rate at which the paper advances. See [Troubleshooting print-quality issues on page 179](#) for steps to determine if paper advance calibration will solve your issue.



You can check the paper advance calibration status of the currently loaded paper at any time from the front panel. Press , then , then **Image quality maintenance > Calibration status**. The status may be one of the following.

- **DEFAULT:** This status appears when loading any paper that has not been calibrated. HP papers in the Front Panel have been optimized by default and unless you experience image quality problems in your printed image such as banding or graininess it is not recommended to recalibrate the paper advance.
- **OK:** This status indicates that the loaded paper has been calibrated before. However you may need to repeat the calibration if you experience image quality problems such as banding or graininess in your printed image.

 **NOTE:** Whenever you update the printer's firmware, the paper advance calibration values are reset to factory default, see [Update the firmware on page 151](#).



 **CAUTION:** Transparent papers and films must be calibrated by pressing , then , then **Image quality maintenance > Paper advance calibration > Adjust paper advance**, from step four in Recalibrating the paper advance procedure.

Recalibrating the paper advance procedure

1. From the front panel, press , then , then **Image quality maintenance > Paper advance calibration > Calibrate paper advance**. The printer automatically recalibrates the paper advance and prints a paper advance calibration image, which you can send to stacker or basket.
2. Wait until the front panel displays the status screen, then reprint your print.

 **NOTE:** The recalibration procedure takes a few minutes. Do not worry about the paper advance calibration image. The front-panel display shows any errors in the process.

If you are satisfied with your print continue using this calibration for your paper type. If you see improvement in your print, continue with step three. If you are dissatisfied with the recalibration, return to the default calibration, see [Return to default calibration on page 183](#).

3. If you would like to fine-tune the calibration or are using a transparent paper, press , then , then **Image quality maintenance > Paper advance calibration > Adjust paper advance**.

4. Select the percentage of change from –100% to +100%. To correct light banding, decrease the percentage.

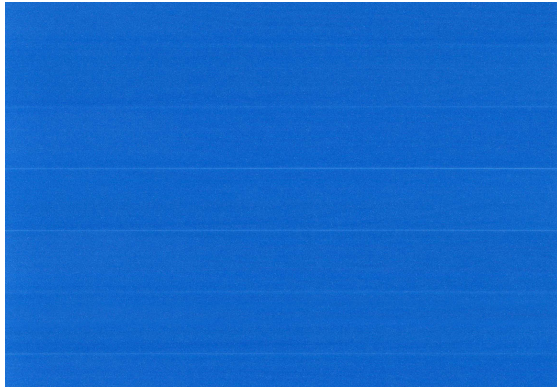

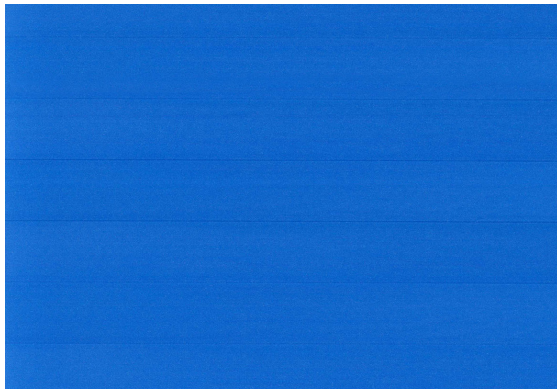

To correct dark banding, increase the percentage.



5. Press **OK** on the front panel, to save the value.
6. Wait until the front panel displays the status screen and reprint your print.

Return to default calibration



Returning to the default calibration sets all the corrections made by the paper advance calibration to zero. To return to the default paper advance calibration value, you must reset the calibration.

1. From the front panel, press  , then  , then **Image quality maintenance > Paper advance calibration > Reset paper advance**.
2. Wait until the front panel displays the operation has completed successfully.

Horizontal lines across the image (banding)

If your printed image suffers from added horizontal lines as shown (the color may vary):



1. Check that the paper type you have loaded corresponds to the paper type selected in the front panel and in your software. See [View information about the paper on page 63](#).
2. Check that you are using appropriate print-quality settings for your purposes (see [Printing on page 69](#)). In some cases, you can overcome a print-quality problem merely by selecting a higher print-quality level. For instance, if you have set the Print Quality slider to **Speed**, try setting it to **Quality**. If you change the print-quality settings, you may wish to reprint your job at this point in case the problem has been solved.
3. Print the Image Diagnostics Print. See [The Image Diagnostics Print on page 194](#).
4. If the printhead is working correctly, go to the front panel and press , then , then **Image quality maintenance > Calibration status** to see the paper advance calibration status. If the status is DEFAULT, try performing paper advance calibration: see [Recalibrate the paper advance on page 182](#).



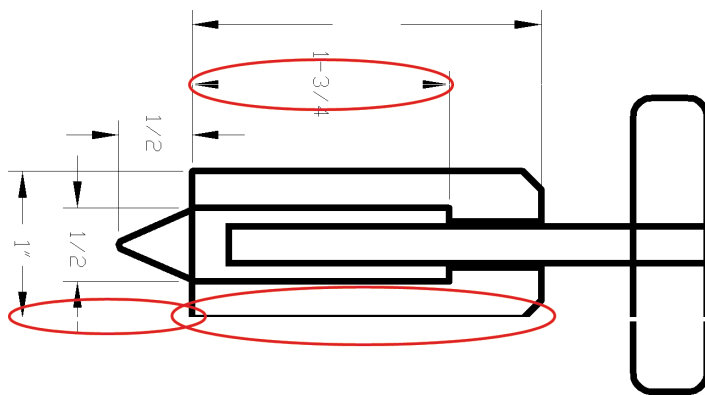

If the problem persists despite all the above actions, contact your customer service representative for further support.

Lines are too thick, too thin or missing



1. Check that the paper type you have loaded corresponds to the paper type selected in the front panel and in your software. See [View information about the paper on page 63](#).
2. Check that you are using appropriate print-quality settings for your purposes (see [Printing on page 69](#)). If printing on photo paper, select the custom print-quality options in the driver dialog, and try turning on the **Maximum detail** option (if available). You may wish to reprint your job at this point in case the problem has been solved.
3. If the resolution of your image is greater than the printing resolution, you may notice a loss of line quality. If you are using the PCL3GUI or the HP-GL/2 driver for Windows, you can find the **Max**.

Application Resolution option in the driver dialog's **Advanced** tab, under **Document Options > Printer Features**. If you change this option, you may wish to reprint your job at this point in case the problem has been solved.

4. When printing on uncoated paper in Fast mode, try loading the paper as Bright Bond.
5. If the problem remains, go to the front panel and press , then , then **Image quality maintenance > Calibration status** to see the printhead alignment status. If the status is PENDING, you should align the printhead. See [Align the printhead on page 228](#). After alignment, you may wish to reprint your job in case the problem has been solved.
6. Go to the front panel and press , then , then **Image quality maintenance > Calibration status** to see the paper advance calibration status. If the status is DEFAULT, you should perform paper advance calibration: see [Recalibrate the paper advance on page 182](#).
7. If lines are too thin or missing, print the Image Diagnostics Print. See [The Image Diagnostics Print on page 194](#).

If the problem persists despite all the above actions, contact your customer service representative for further support.

Lines appear stepped or jagged

If lines in your image appear stepped or jagged when printed:

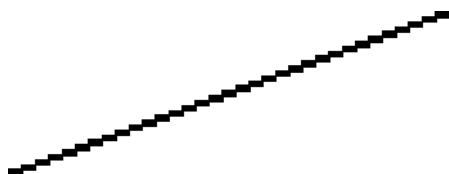

1. The problem may be inherent in the image. Try to improve the image with the application you are using to edit it.
2. Check that you are using appropriate print-quality settings. See [Printing on page 69](#).
3. Select the custom print-quality options in the driver dialog, and turn on the **Maximum detail** option (if available).

Lines print double or in the wrong colors

This problem can have various visible symptoms:

- Colored lines are printed double, in different colors.

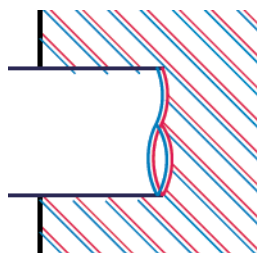

- The borders of colored blocks are wrongly colored.

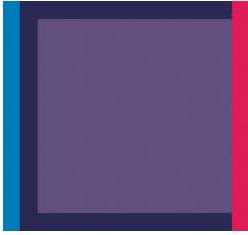

To correct this kind of problem:

1. Align the printhead. See [Align the printhead on page 228](#).
2. Reseat the printhead by removing and then reinserting it. See [Remove the printhead on page 141](#) and [Insert the printhead on page 145](#).

Lines are discontinuous

If your lines are broken in the following way:



1. Check that you are using appropriate print-quality settings. See [Printing on page 69](#).
2. When printing on uncoated paper in Fast mode, try loading the paper as Bright Bond.
3. Align the printhead. See [Align the printhead on page 228](#).
4. Reseat the printhead by removing and then reinserting it. See [Remove the printhead on page 141](#) and [Insert the printhead on page 145](#).

Lines are blurred



Humidity can cause ink to soak into the paper, making the lines blurred and fuzzy. Try the following:

1. Check that your environmental conditions (temperature, humidity) are suitable for high-quality printing. See [Environmental specifications on page 249](#).
2. Check that the paper type selected in the front panel is the same as the paper type you are using. See [View information about the paper on page 63](#).
3. Try changing to a heavier paper type, such as HP Heavyweight Coated Paper or HP Super Heavyweight Plus Matte Paper.
4. Select a paper type that is slightly thinner than the paper you have loaded; this will persuade the printer to use less ink. Here are some example paper types in ascending order of thickness: Plain Paper, Coated Paper, Heavyweight Coated Paper, Super Heavyweight Plus Matte Paper.
5. If you are using photo paper, try changing to a different type of photo paper.
6. Align the printhead. See [Align the printhead on page 228](#).

Line lengths are inaccurate

If you have measured your printed lines and find that the lengths are not sufficiently accurate for your purposes, you can try to improve line length accuracy in the following ways.





1. Print on HP Matte Film, for which your printer's line length accuracy is specified. See [Functional specifications on page 246](#).

Polyester film is about ten times more dimensionally stable than paper. However, using film that is thinner or thicker than HP Matte Film will reduce line length accuracy.
2. Set the Print Quality slider to **Quality**.
3. Maintain the room at a steady temperature between 10 and 30°C (50 and 86°F).
4. Load the roll of film and let it rest for five minutes before printing.
5. If you are still not satisfied, try recalibrating the paper advance. See [Recalibrate the paper advance on page 182](#).

The whole image is blurry or grainy



1. Check that the paper type you have loaded corresponds to the paper type selected in the front panel and in your software. See [View information about the paper on page 63](#).
2. Check that you are printing on the correct side of the paper.

3. Check that you are using appropriate print-quality settings (see [Printing on page 69](#)). In some cases, you can overcome a print-quality problem merely by selecting a higher print-quality level. For instance, if you have set the Print Quality slider to **Speed**, try setting it to **Quality**. If you change the print-quality settings, you may wish to reprint your job at this point in case the problem has been solved.
4. Go to the front panel and press , then , then **Image quality maintenance > Calibration status** to see the printhead alignment status. If the status is PENDING, you should align the printhead. See [Align the printhead on page 228](#). After alignment, you may wish to reprint your job in case the problem has been solved.
5. Go to the front panel and press , then , then **Image quality maintenance > Calibration status** to see the paper advance calibration status. If the status is DEFAULT, you should perform paper advance calibration: see [Recalibrate the paper advance on page 182](#).

If the problem persists despite all the above actions, contact your customer service representative for further support.

The paper is not flat

If the paper does not lie flat when it comes out of the printer, but has shallow waves in it, you are likely to see defects in the printed image, such as vertical stripes. This can happen when you use thin paper that becomes saturated with ink.



1. Check that the paper type you have loaded corresponds to the paper type selected in the front panel and in your software. See [View information about the paper on page 63](#).
2. Try changing to a thicker paper type, such as HP Heavyweight Coated Paper or HP Super Heavyweight Plus Matte Paper.
3. Select a paper type that is slightly thinner than the paper you have loaded; this will persuade the printer to use less ink. Here are some example paper types in ascending order of thickness: Plain Paper, Coated Paper, Heavyweight Coated Paper, Super Heavyweight Plus Matte Paper.
4. If you see horizontal stripes, try printing the same job rotated; this sometimes reduces the visibility of the stripes.

The print is scuffed or scratched

The black ink pigment can be scuffed or scratched when touched by a finger, a pen or some other object. This is particularly noticeable on coated paper.

Photo paper may be extremely sensitive to the basket or to anything else that it contacts soon after printing, depending on the amount of ink used and the environmental conditions at the time of printing.

To reduce the risk of scuffs and scratches:

- Handle prints carefully.
- Catch your prints as they are cut from the roll and do not let them fall into the basket. Alternatively, leave a sheet of paper in the basket so that freshly printed sheets do not make direct contact with the basket.

Ink marks on the paper

This problem can occur for several different reasons.

Horizontal smears on the front of the paper

When a lot of ink is used on a paper-based material, the paper absorbs the ink quickly and expands. If the paper is stiff and curled, near the end of the roll the leading edge of the paper may rise slightly in the print area. As the printhead moves over the paper, it may come into contact with the paper and smear the printed image.

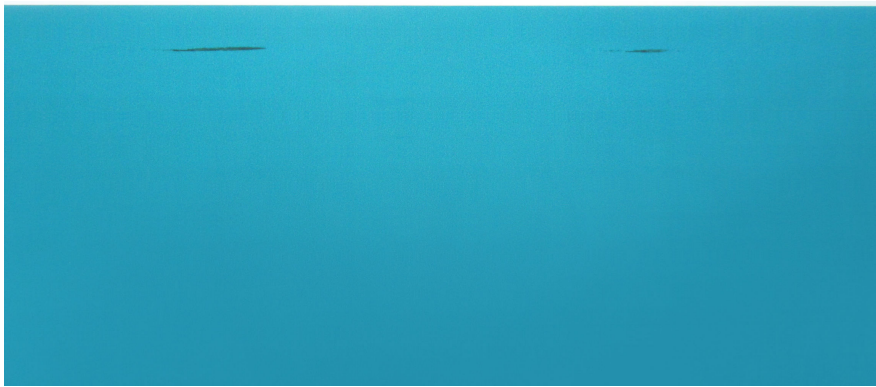

Whenever you notice this problem, cancel the printing job immediately. Press  on the front panel and also cancel the job from your computer application. Soaked paper can damage the printhead.

Try the following suggestions to avoid this problem:

1. Increase the margins by relocating the image to the center of the page, either with your software or with the front panel's **Move Paper** option (see [Move the paper on page 65](#)). To prevent such smears most effectively, the distance from the image to the leading edge of the paper should be at least 20 mm (0.8 in).
2. Select a faster print mode: change from Best to Normal, or from Normal to Fast mode.

Other smears on the paper

The following suggestions may be used for all kinds of smears, including those on the front of the paper:

1. Check that the paper type you have loaded corresponds to the paper type selected in the front panel and in your software. See [View information about the paper on page 63](#).
2. Use a recommended paper type (see [Order paper on page 166](#)) and the correct print settings.

3. If using sheet paper, try rotating the sheet 90 degrees. The orientation of the paper fibers may affect performance.
4. Try changing to a thicker paper type, such as HP Heavyweight Coated Paper or HP Super Heavyweight Plus Matte Paper.
5. Select a paper type that is slightly thinner than the paper you have loaded; this will persuade the printer to use less ink. Here are some example paper types in ascending order of thickness: Plain Paper, Coated Paper, Heavyweight Coated Paper, Super Heavyweight Plus Matte Paper.

Black ink comes off when you touch the print

This problem may be caused by printing with matte black ink on photo paper. The printer will not use matte black ink if it knows that the paper will not retain it. To be sure of avoiding matte black ink, you can select Photo Gloss Paper as the paper type (in the Photo Paper category).

Edges of objects are stepped or not sharp



If edges of objects or lines appear to be poorly defined or lighter in density, and you have already set the print-quality slider to **Quality** in the driver dialog, select the custom print-quality options, and try setting the quality level to **Normal**. See [Printing on page 69](#).

Edges of objects are darker than expected



If edges of objects seem darker than expected, and you have already set the print-quality slider to **Quality** in the driver dialog, select the custom print-quality options, and try setting the quality level to **Normal**. See [Printing on page 69](#).

Horizontal lines at the end of a cut sheet print

This type of defect affects only the end of a print, within approximately 30 mm of the trailing edge of the paper. You may see some very thin horizontal lines across the print.

To avoid this problem:

1. Print the Image Diagnostics Print. See [The Image Diagnostics Print on page 194](#).
2. Consider printing with roll paper.
3. Consider using larger margins around your image.

Vertical bands of different colors

If your print has vertical bands of different colors along it:

1. Try using higher print-quality settings (see [Printing on page 69](#)). For instance, if you have set the Print Quality slider to **Speed**, try setting it to **Quality**.
2. Try using thicker paper, choosing from the recommended paper types such as HP Heavyweight Coated Paper and HP Super Heavyweight Paper. See [Order paper on page 166](#).

White spots on the print



You may notice white spots on the print. This is probably due to paper fibers, dust or loose coating material. To avoid this problem:

1. Try cleaning the paper manually with a brush before printing, to remove any loose fibers or particles.
2. Always keep the cover of your printer closed.
3. Protect your paper rolls and sheets by storing them in bags or boxes.

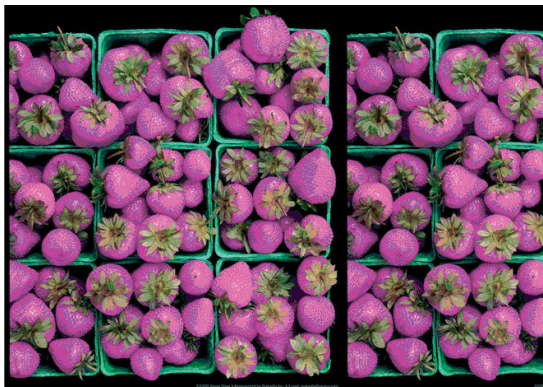
Colors are inaccurate



If the colors of your print do not match your expectations, try the following:

1. Check that the paper type you have loaded corresponds to the paper type selected in the front panel and in your software. See [View information about the paper on page 63](#). Also, press , then , then **Image quality maintenance > Calibration status** to check the color calibration status. If the status

is PENDING or OBSOLETE, you should perform color calibration: see [Color calibration on page 104](#). If you have made any changes, you may wish to reprint your job in case the problem has been solved.

2. Check that you are printing on the correct side of the paper.
3. Check that you are using appropriate print-quality settings (see [Printing on page 69](#)). If you have selected the **Speed** or **Fast** options, you may not get the most accurate colors. If you change the print-quality settings, you may wish to reprint your job at this point in case the problem has been solved.
4. If you are using Application Color Management, check that the color profile you are using corresponds to the selected paper type and print-quality settings. If you have doubts about which color settings to use, see [Color management on page 103](#).
5. If the problem consists of color differences between your print and your monitor, please follow the instructions in the “How to calibrate your monitor” section of the HP Color Center. At this point, you may wish to reprint your job in case the problem has been solved.
6. Print the Image Diagnostics Print. See [The Image Diagnostics Print on page 194](#).
7. Try using the color adjustment options to produce the colors you want. See [Color adjustment options on page 107](#).

If the problem persists despite all the above actions, contact your customer service representative for further support.

Color accuracy using EPS or PDF images in page layout applications

Page layout applications such as Adobe InDesign and QuarkXPress do not support color management of EPS, PDF or grayscale files.

If you have to use such files, try to ensure that the EPS, PDF or grayscale images are already in the same color space that you intend to use later on in Adobe InDesign or QuarkXPress. For instance, if your final goal is to print the job in a press that follows the SWOP standard, convert the image into SWOP when you create it.

Colors are fading

If you print on instant-dry photo paper, your prints will fade rapidly. If you plan to display the prints for more than two weeks, you should laminate them to achieve longer life.

Prints on swellable coated papers will fade much less rapidly. However, lamination will increase the life of prints (depending on the type of lamination) with all paper types. For more information, consult your laminate provider.

The image is incomplete (clipped at the bottom)

- Did you press  before all the data were received by the printer? If so, you have ended the data transmission and will have to print the page again.
- There may be a communications problem between your computer and the printer. Check your network cable.
- Check to make sure that your software settings are correct for your current page size (for example, long-axis prints).
- If you are using network software, make sure it has not timed out.

The image is clipped

Clipping normally indicates a discrepancy between the actual printable area on the loaded paper and the printable area as understood by your software. You can often identify this kind of problem before printing by previewing your print (see [Preview a print on page 78](#)).

- Check the actual printable area for the paper size you have loaded.
printable area = paper size – margins
- Check what your software understands to be the printable area (which it may call "printing area" or "imageable area"). For example, some software applications assume standard printable areas that are larger than those used in this printer.
- If you have defined a custom page size with very narrow margins, the printer may impose its own minimal margins, clipping your image slightly. You may want to consider using a larger paper size, or borderless printing (see [Select margins options on page 76](#)).
- If your image contains its own margins, you may be able to print it successfully by using the **Clip Contents by Margins** option (see [Select margins options on page 76](#)).
- If you are trying to print a very long image on a roll, check that your software is capable of printing an image of that size.
- You may have asked to rotate the page from portrait to landscape on a paper size that is not wide enough.
- If necessary, reduce the size of the image or document in your software application, so it fits between the margins.

There is another possible explanation for a clipped image. Some applications, such as Adobe Photoshop, Adobe Illustrator and CorelDRAW, use an internal 16-bit coordinate system which means that they cannot handle an image of more than 32,768 pixels.



NOTE: An image 32,768 pixels long would print at a length of 1.39 m (54.61 in) if you select Best or Quality in the driver, 2.78 m (109.23 in) if you select Fast, Normal or Speed in the driver.

If you try to print an image larger than this from these applications, the bottom of the image may be clipped. To print the whole image, try these suggestions:

- Try using the PostScript printer driver to print your job, if you have not already tried it.
- The Windows HP-GL/2 driver dialog includes an option called **Max. application resolution**, which enables you to print successfully in this situation. You will not normally need to change the default setting, which is **Auto**. However, you can find the option in the **Advanced** tab, under **Document Options > Printer Features**.
- Save the file in another format, such as TIFF or EPS, and open it with another application.
- Use a RIP to print the file.

Some objects are missing from the printed image

Large quantities of data may be necessary to print a high-quality large-format print job, and in some specific workflows there may be issues that can lead to some objects missing from the output. Here are some suggestions to help you to avoid this problem.

- Try using the PostScript printer driver to print your job, if you have not already tried it.
- Select a smaller page size and scale to the desired final page size in the driver or in the front panel.
- Save the file in another format, such as TIFF or EPS, and open it with another application.
- Use a RIP to print the file.
- Reduce the resolution of bitmap images in your application software.
- Select a lower print quality in order to reduce the resolution of the printed image.



NOTE: If you are working under Mac OS X, not all of these options are available.

These options are suggested for troubleshooting purposes and may adversely affect the final output quality or the time necessary to generate the print job. Therefore, they should be cancelled if they do not help to solve the problem.



A PDF file is clipped or objects are missing

In older versions of Adobe Acrobat or Adobe Reader, large PDF files could be clipped or lose some objects when printing with the HP-GL/2 driver at high resolution. In order to avoid such problems, update your Adobe Acrobat or Adobe Reader software to the latest version. From version 7 onwards, these problems should be solved.

The Image Diagnostics Print

The Image Diagnostics Print consists of patterns designed to highlight printhead reliability problems. It helps you to check the performance of the printhead, and whether it suffers from clogging or other problems.

To print the Image Diagnostics Print:

1. Use the same paper type that you were using when you detected a problem.
2. Check that the selected paper type is the same as the paper type loaded into the printer. See [View information about the paper on page 63](#).
3. At the printer's front panel, press , then , then select **Image Quality Maintenance > Print diagnostic image**.

It takes about two minutes to print the Image Diagnostics Print.

The print is divided into two parts, both of which test printhead performance.

- Part 1 (top) consists of rectangles of pure colors, one for each ink. This part represents the print quality that you will get from each color.
- Part 2 (bottom) consists of small dashes, one for each printhead nozzle. This part complements the first, and aims more specifically to detect how many faulty nozzles each printhead has.

Please look carefully at the print. The names of the colors are shown above the rectangles and to the left of the patterns of dashes.

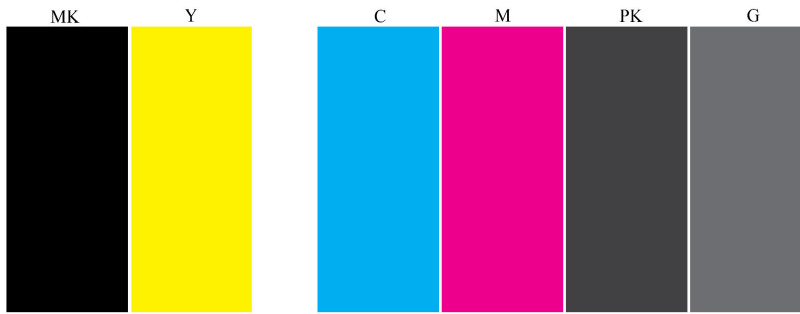

First look at the upper part of the print (part 1). Each colored rectangle should be a uniform color without any horizontal lines across it.

Then look at the bottom part of the print (part 2). For each individual colored pattern, check that most of the dashes are present.

If you see horizontal lines in part 1 and also missing dashes in part 2 for the same color, you should clean the printhead, selecting the relevant color group. However, if the rectangles look solid, do not worry about just a few missing dashes in part 2; these are acceptable because the printer can compensate for a few clogged nozzles.

Here is an example of a gray printhead in a good state:

G

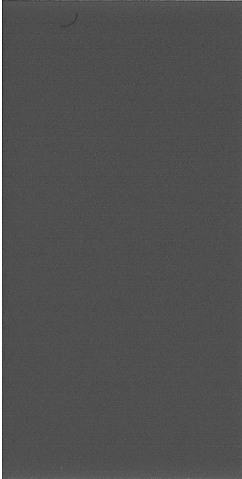

And here is an example of the same printhead in a bad state:

G

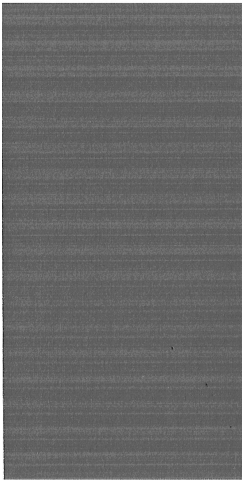

Corrective action

1. Clean the printhead if necessary (see [Clean the printhead on page 228](#)). Then reprint the Image Diagnostics Print to see whether the problem has been solved.
2. If the problem remains, clean the printhead again, and reprint the Image Diagnostics Print to see whether the problem has been solved.
3. If the problem still remains, replace the printhead (see [Handling ink cartridges and printhead on page 136](#)), or contact HP Support (see [Contact HP Support on page 243](#)).

If you still have a problem

If you still experience print-quality problems after applying the advice in this chapter, here are some further things that you can do:

- Try using a higher print-quality option. See [Printing on page 69](#).
- Check the driver you are using to print with. If it is a non-HP driver, consult the driver vendor about the problem. You could also try using the correct HP driver, if feasible. The latest HP drivers can be downloaded from <http://www.hp.com/go/T2500/drivers>.
- If you are using a non-HP RIP, its settings may be incorrect. See the documentation that came with the RIP.
- Check that your printer's firmware is up to date. See [Update the firmware on page 151](#).
- Check that you have the right settings in your software application.

22 Troubleshooting scanner issues

Cannot access the network folder

If you have set up a network folder (see [Configure a scan-to-network or scan-to-FTP folder on page 23](#)), but the printer cannot access it, try the following suggestions.

- Check that you have filled in each field correctly.
- Check that the printer is connected to the network.
- Check that the remote computer is switched on, working normally and connected to the network.
- Check that the folder is shared.
- Check that you can put files into the same folder from a different computer on the network, using the printer's logon credentials.
- Check that the printer and the remote computer are in the same network subnet; if they are not, check that the network routers are configured to forward the CIFS protocol traffic (also known as Samba).

Scanning to file is slow

Scanning large formats creates large files. This means that scanning to file can take time even under optimal system configurations and conditions. This is especially true when scanning across a network. However, if you think scanning to file with your system is unreasonably slow, the following steps may help you to locate and solve the problem.

1. Use the front panel to check the status of your scan job. If it is taking an intolerably long time, you can select the job and then cancel it.
2. Check that the **Resolution** setting is right for the job. Not all scanning tasks require high resolutions. If you lower the resolution, you will speed up the scanning process. For JPEG and PDF scan jobs, you can also change the **Quality** setting. Lower quality values produce smaller files.
3. Check your network configuration. Your network should be a Gigabit Ethernet or one of a higher transfer rate in order to achieve optimal scanning speeds. If your network is a 10/100 Ethernet configuration, you can expect slower transfer of the scan data and thus slower scanning speeds.
4. Contact your network administrator for information about your network configuration, transfer rates, scan-to-file destinations on the network and possible solutions for increasing the speeds.

5. If scanning to files on the network is too slow and the network configuration cannot be amended to correct this, improved speeds can be achieved by scanning to a USB flash drive.
6. If scanning to a USB flash drive seems slow, check your USB flash drive interface compatibility. Your system supports a Hi-Speed USB interface. Your USB flash drive should be compatible with Hi-Speed USB (sometimes known as USB 2). Also check that your USB flash drive contains enough storage space for scanned large-format images.

23 Troubleshooting scan-quality issues

- [Random vertical lines](#)
- [Wrinkles or folds](#)
- [Line discontinuities](#)
- [Grain in area fills when scanning plain paper](#)
- [Small color differences between adjacent CIS modules](#)
- [Vertical light lines at the intersection between CIS modules](#)
- [Variable line thickness or missing lines](#)
- [Inaccurately reproduced colors](#)
- [Color fringing](#)
- [Clipping in dark or light areas](#)
- [Flare in the image when scanning glossy originals](#)
- [Vertical red and green bands over white or black background](#)
- [The stop-start effect](#)
- [Vibration](#)
- [Horizontal periodical banding](#)
- [Defocus, blurring and fading colors](#)
- [Incorrect paper advance, skew during scanning, or horizontal wrinkles](#)
- [Vertical black band 20 cm wide](#)
- [The scanner damages some originals](#)
- [Completely wrong colors](#)
- [Vertical distortion](#)
- [Object replication \(ghosting\)](#)
- [Clipping or incorrect scale factor when down-scaling in copies and prints](#)
- [Incorrect edge detection, mostly when scanning tracing paper](#)

- [A copied or scanned image is very skewed](#)

In this chapter the most common defects and failure modes are shown, sorted by relevance and frequency of appearance. A defect is a common image artifact that usually appears when using any CIS scanner. These are due to incorrect settings, product limitations, or easily solvable mistakes. A failure mode is due to malfunctions of some of the scanner components.

Some of the corrective actions proposed here require the use of the Scanner Diagnostic Plot, which you can print and scan as indicated in [The scanner diagnostic plot on page 219](#). Please do not use any printed version of this guide to test the scanner, as the resolution of the images included here is insufficient. Use the diagnostic plot when recommended in response to any of the errors described in this chapter.

Random vertical lines

This is one of the most common issues in sheet-fed scanners. Usually, the vertical streaks are caused by dust particles inside the scanner, or miscalibration of the scanner (in these cases, the problem can be solved). Here are some examples of images suffering from vertical lines or streaks. Please note the black arrow indicating the scanning direction in these examples.



Actions

1. Clean the scanner's glass plate and the original to be scanned as described in [Clean the scanner's glass plate on page 155](#). Re-scan your original afterwards.
2. If the streaks remain, recalibrate the scanner as indicated in [Calibrate the scanner on page 163](#). Make sure you clean the maintenance sheet before calibrating the scanner, and check that the maintenance sheet is not damaged (if so, call HP support and ask for a new maintenance sheet). Re-scan your original after the calibration is completed.
3. If the streaks still remain, check the scanner's glass plate visually. If it is damaged (scratched or broken), call HP support.
4. If the streaks remain, there may be dust particles inside the glass plate. Carefully take out the glass plate and clean it as described in [Replace the scanner's glass plate on page 158](#).

 **NOTE:** The problem of vertical streaks cannot always be solved, due to the technological limitations of CIS technology. HP offers HD Scanners with CCD technology for higher quality requirements. If the streaks remain after the corrective actions explained above, then no further action can be taken to improve the image quality, except to buy a more expensive CCD scanner.

Wrinkles or folds

Scanners based on CIS technology have a high optical resolution within their focus plane, at the price of a very limited depth of field. Hence, the images are sharp and detailed when the scanned original is perfectly flat against the glass plate. However, whenever the original contains wrinkles or folds, these defects are clearly visible in the scanned image (as shown in the following example).

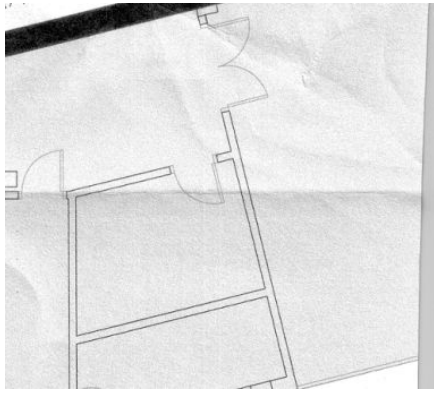

Actions

1. Re-scan the original, setting the content type to **Image**, and contrast and background cleaning to zero.
2. If the problem persists, re-scan the original at a lower scanner resolution (Standard quality if scanning, Fast or Normal if copying). It may also help to flatten the original manually as much as possible before scanning it again.



NOTE: The problem of wrinkles cannot always be solved, due to the technological limitations of CIS technology. HP offers HD Scanners with CCD technology for higher quality requirements. If the wrinkles remain after the corrective actions explained above, then no further action can be taken to improve the image quality, except to buy a more expensive CCD scanner.

Line discontinuities

When scanning or copying large originals, you may sometimes find issues such as that shown in the following image, where a straight line (it does not necessarily have to be horizontal) appears with discontinuities or small steps. Please note the black arrow indicating the scanning direction in this example.



Actions

1. Repeat the scan, and this time make sure that the product is correctly positioned (it is flat on the floor and it does not move), and that the printer is not printing while you scan. Turning the original 90 or 180 degrees and scanning it again may also solve the problem.
2. If the problem persists, check that the original to be scanned is not skewed, and that it does not become skewed during the scan. If so, please refer to [Incorrect paper advance, skew during scanning, or horizontal wrinkles on page 213](#). You might also want to deactivate the automatic de-skew algorithm as indicated in [A copied or scanned image is very skewed on page 218](#).
3. If there is no skew but the problem persists, clean and calibrate the scanner as indicated in [Scanner maintenance on page 154](#). Take care not to move the printer during the calibration (the printer should not be printing during scanner calibration), and check that the maintenance sheet is correctly positioned before starting the calibration. Also check that the maintenance sheet is not damaged before

calibrating the scanner (an old or damaged maintenance sheet may cause this problem); if it is damaged, call HP support and ask for a new maintenance sheet.

4. If the problem persists, proceed to analyze the following areas of the diagnostic plot:

- a. 4 (from module A to E).
- b. 10, at the intersection between modules.
- c. 13 in modules A and E, and 14 in modules B, C, and D.

If you see any of these defects in the studied areas, call HP support and report a “line discontinuities” error after calibration.

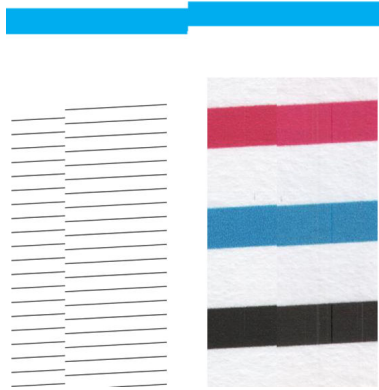

The four vertical thin black lines at the beginning and the end of the diagnostic plot show, approximately, the position of the intersection between CIS modules, where this kind of error usually appears. If the error appears outside these areas, call HP support and report “line discontinuities within a CIS module”.

Grain in area fills when scanning plain paper

When making copies of an original containing area fills, if the paper used in the printer is plain paper (for instance, HP Universal Bond or HP Bright White Inkjet Bond), some grain may appear in the image. This error may also appear in scanned files of originals that were printed on textured paper. The example below shows the original image on the left and the scanned, grainy image on the right.



Actions

1. Please look at the original and check if it is dirty, has fingerprints on it or if the grain is already present in the print. If not, then proceed to step 2.
2. Repeat the scan/copy, setting the content type to **Image**.
3. If the problem persists:
 - If the problem appears when copying, use Best quality. We also recommend using coated or glossy paper in order to avoid grain in copies.
 - If the problem appears in a scanned file, scan at a lower resolution (Standard quality).
4. If the problem persists, clean and calibrate the scanner as indicated in [Scanner maintenance on page 154](#). Check that the maintenance sheet is also clean, and that it is not damaged before calibrating the scanner (an old or damaged maintenance sheet may cause this problem); if it is damaged, call HP support and ask for a new maintenance sheet.
5. If the problem persists, proceed to analyze areas 11 and 12 of the diagnostic plot across modules A to E. In the three examples below, the top example is ideal, the middle example can be regarded as acceptable; but, if you see something similar to the bottom example (or worse), call HP support and report “grain in area fills”.

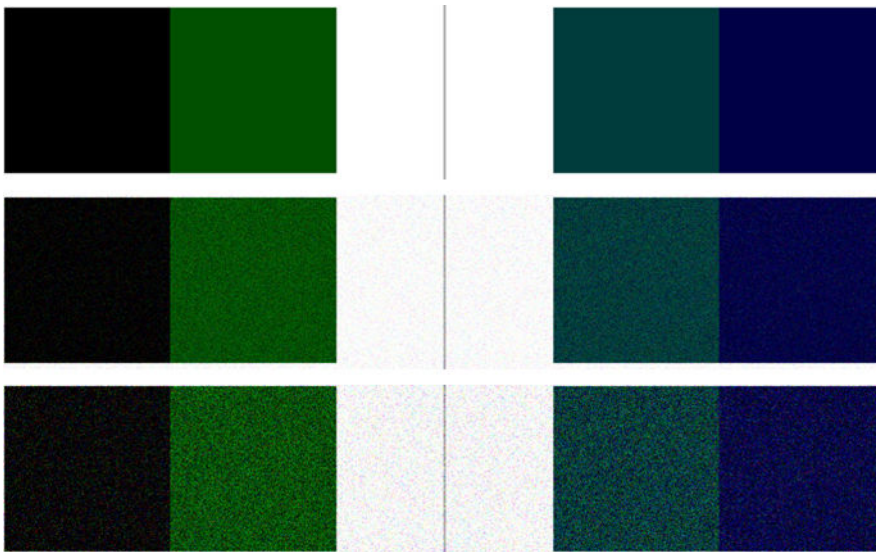

Small color differences between adjacent CIS modules

When scanning wide plots, sometimes slightly different colors can be seen at both sides of the junction between two CIS modules. This issue, if present, can be easily seen by analyzing patterns 9 of the diagnostic plot at the intersection between CIS modules. Here are some examples. Please note the black arrow indicating the scanning direction in these examples.

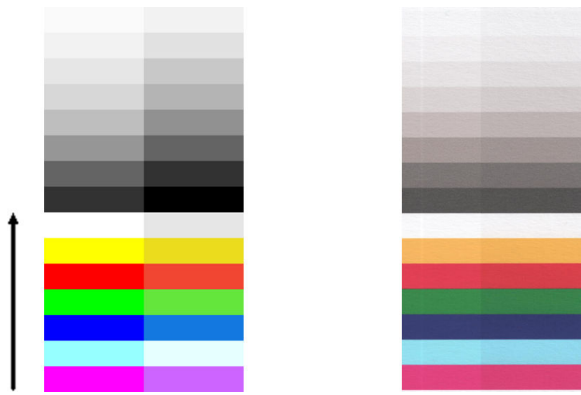

Sometimes the color mismatch between adjacent modules can be enormous, showing a serious scanner malfunction, as in the following example. If this occurs, see [Completely wrong colors on page 215](#).

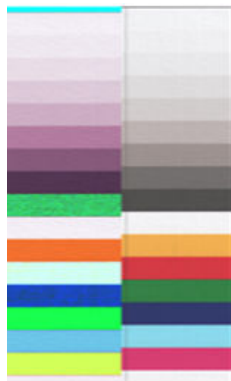

Actions

1. Repeat the scan or copy, setting the content type to **Image**, reducing the background cleaning to 0 or turning the original 90 degrees before scanning it again.
2. If the problem persists, clean and calibrate the scanner as indicated in [Scanner maintenance on page 154](#). If calibration ended without errors, proceed to analyze again pattern number 9 and modules A through E of the diagnostic plot.
3. After analyzing pattern 9, if you see some color differences between left and right sides of the bars for neutral and vivid colors, call HP support and report “small color differences between adjacent CIS modules”. Otherwise, if you see color differences for vivid colors but not for neutral colors, see [Clipping in dark or light areas on page 208](#). If necessary, see also [Grain in area fills when scanning plain paper on page 203](#).

Vertical light lines at the intersection between CIS modules

This problem can be found when scanning large uniform area fills which are made of some light color. You sometimes find light vertical bands (around 0.5 cm wide) at the intersection between two CIS modules, as in this example. Please note the black arrow indicating the scanning direction in this example.



Actions

1. Repeat the scan or copy, setting the content type to **Image**, reducing the background cleaning to 0 or turning the original 90 degrees before scanning it again.
2. If the problem persists, clean and calibrate the scanner as indicated in [Scanner maintenance on page 154](#). Then proceed to analyze pattern number 2 of the diagnostic plot at the intersections between CIS modules. The example below shows a good result on the left and a bad result on the right: the latter has light vertical banding 0.5 cm wide at the intersection between two CIS modules.



If you see the kind of result shown on the right, call HP support and report “vertical light bands in area fills at the intersection between CIS modules, after calibrating the scanner”.

Variable line thickness or missing lines

When scanning some CAD plots at Standard resolution, mostly when working with grayscale or black-and-white prints that contain very thin lines, you may see a variation in line thickness, or even some missing lines, in some places:

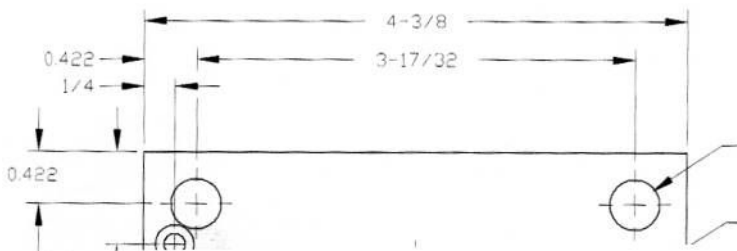

Actions

1. Repeat the scan or copy using a higher resolution (High or Max if scanning, Normal or Best if copying). You should also set background cleaning to 0, or set the content type to **Mixed**. You might also deactivate the automatic de-skew as explained in [A copied or scanned image is very skewed on page 218](#). In case you were working in black-and-white mode, we recommend using grayscale instead.
2. If the problem persists, turn the original plot 90 degrees before scanning it again.
3. If the problem persists, clean and calibrate the scanner as indicated in [Scanner maintenance on page 154](#).
4. If the problem persists, see [Defocus, blurring and fading colors on page 212](#).

Inaccurately reproduced colors

You have to deal with several variables if you want perfect color matching between the original you are scanning and the copy or scanned file you obtain as a result. If you find undesired colors in cases like the example shown below (original on the left, scanned image on the right), you can follow these guidelines.



Actions

1. Make sure that you choose the correct paper type in the scan settings before scanning.
2. When dealing with copies, you must take into account that good color matching between a given original and its copy can be achieved only if both are printed on the same type of paper. In the case of scanned files, good color matching can be achieved only if your monitor is color-calibrated or compliant with sRGB or AdobeRGB standards.
3. If the above conditions are met, you should also take into account that various scanner settings can affect the final color result, such as contrast, background cleaning, content type and paper type. To obtain the best possible colors, set contrast and background cleaning to 0, set the content type to **Image**, and select the most appropriate type of paper according to the original you are scanning (if in doubt, use photo paper).
4. Note that the image enhancement settings are automatically reset to default values after a certain time, so you may get a different result from copying the same original if you have not checked the settings before starting the job.
5. If you scanned to a PDF file, try opening the PDF file in Adobe Acrobat and saving it as a PDF/A file. For more information, see <http://www.adobe.com/products/acrobat/standards.html> (English only).
6. For optimum color results, clean and calibrate the scanner as indicated in [Scanner maintenance on page 154](#).
7. Avoid placing the scanner in direct sunlight or near sources of heat or cold.

Color fringing

The problem called “color fringing” occurs when the scanner is affected by incorrect paper advance and/or miscalibration. Nevertheless, some amount of color fringing is unavoidable, especially at high scanning speeds. It can be seen at the borders of sharp black text over a white background, as in the example below (original on the left, scanned image on the right). Please note the black arrow indicating the scanning direction.



Actions

1. Repeat the scan after increasing the scanner’s resolution (choose Max quality if scanning, Best if copying). Turn your original 90 degrees, if possible, before scanning it again.
2. If the problem persists, clean and calibrate the scanner as indicated in [Scanner maintenance on page 154](#). Repeat the scan at a high resolution (Max if scanning, Best if copying) and check whether the problem disappears.

3. If the problem still persists, you can diagnose this issue by analyzing the patterns 6 and 8 (A to E) of the diagnostic plot. The black horizontal lines appear slightly colored at the top and bottom of each end (in the example on the right, below). Normally, they look red at the top and blue or green at the bottom, but it could be the other way around.



If you see this effect, call HP support and report “color fringing problem after calibration”.

Clipping in dark or light areas

Sometimes you may see that the scanned file or copy of one of your plots has lost detail in light or dark areas (or both), as in the example below: original on the left, scanned image on the right.



Image © www.convincingblack.com, reproduced with permission.

Actions

1. If you are making copies, and the original is printed on photographic paper, while you are copying it onto matte paper, this problem is to be expected. However, you can try to improve the result by running a color calibration of the printer (see *Using your printer*), and by reducing contrast and background cleaning; this also applies if you see this problem in scanned files.
2. If the problem persists, repeat the scan or copy using a higher resolution (High or Max if scanning, Normal or Best if copying). Set the content type to **Image**, and make sure that the type of original selected in the front panel really corresponds to the paper type of your original (white, photo, recycled or translucent). If you are not sure, select photo.
3. If the problem persists, recalibrate the scanner as indicated in [Scanner maintenance on page 154](#). Make sure you clean the maintenance sheet before calibrating the scanner, and check that the maintenance sheet is not damaged (if so, call HP support and ask for a new maintenance sheet). Re-scan your original after the calibration is completed.
4. If the problem persists, analyze patterns 16 (A to E) of the diagnostic plot. If you can distinguish lightness steps beyond the upper and lower specified thresholds, then the scanner is fine. Here you can see some examples of correct and incorrect functioning.



If your scanned pattern looks like the incorrect one on the right, whether the clipping is in dark and/or light areas, call HP support and report “Clipping in dark/light areas”.

Flare in the image when scanning glossy originals

If the scanner is miscalibrated, or if the original plot you are trying to scan is very glossy or reflective, you can sometimes find flare in the scanned image, as in the following example: original on the left, scanned image on the right.



Image © www.convincingblack.com, reproduced with permission.

Actions

1. Clean the original and the scanner's glass plate, then scan again.
2. If the problem persists, recalibrate the scanner as indicated in [Scanner maintenance on page 154](#). Make sure you clean the maintenance sheet before calibrating the scanner, and check that the maintenance sheet is not damaged (if so, call HP support and ask for a new maintenance sheet). Re-scan your original after the calibration is completed.
3. If the problem persists, see [Clipping in dark or light areas on page 208](#).

Vertical red and green bands over white or black background

If the scanner has not been calibrated for a long period of time, or if the last calibration failed, you can sometimes see defects like the following. Please note the black arrow indicating the scanning direction in this example: original on the left, scanned image on the right.

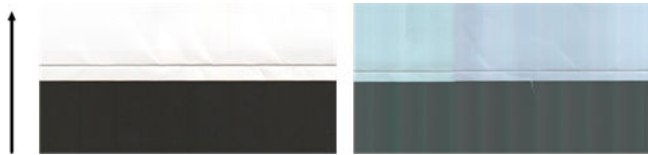

Actions

1. Clean and calibrate the scanner as indicated in [Scanner maintenance on page 154](#). If the calibration failed, proceed as stated in [Calibrate the scanner on page 163](#). However, if the calibration ended correctly, scan your original again and check that the colored vertical bands have disappeared.
2. If the problem persists, call HP support and report “vertical red/green bands after calibration”.

The stop-start effect

Your printer is a complex machine, which may be working on several tasks at the same time. If you are trying to scan while printing or processing a job in the printer queue, you may find that the scanner stops for a while and then restarts. Although this is normal behavior, in some cases the scanned image may have defects as a result of this stop-start operation.

To illustrate this effect, here is an example of an original image.



The two images below are examples of the stop-start effect when the above image is scanned. Please note the black arrow indicating the scanning direction in these examples.



Actions

1. Clean and calibrate your scanner as indicated in [Scanner maintenance on page 154](#). Scan your original again and make sure that the printer is not working while you are scanning. Reduce scanning resolution (choose Standard if scanning, Fast if copying) if necessary.

2. If the problem persists, proceed to analyze patterns 4, 13, and 14 of the diagnostic plot. If you find a problem similar to that shown below, call HP support and report a “stop-start effect” error.

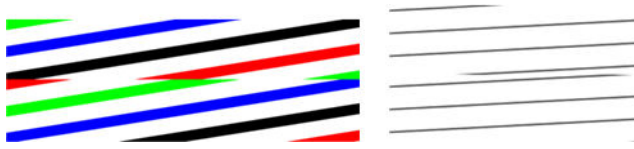

Vibration

If your printer is not properly placed on a flat surface, or if the scanner lid does not close correctly, you may sometimes find that the scanned image suffers from vibration, as in the following example: original on the left, scanned image on the right.



1. Make sure that the scanner is placed on a flat surface, the scanner lid is correctly closed, and the printer is not working while you are scanning. Scan your original again.
2. If the problem persists, change (increase or decrease) the scanning resolution and re-scan your original. We also recommend turning the original 90 degrees before scanning it again.
3. If the problem persists, analyze pattern 4 of the diagnostic plot. If you see the problem shown on the right, call HP support and report a “vibration problem”.

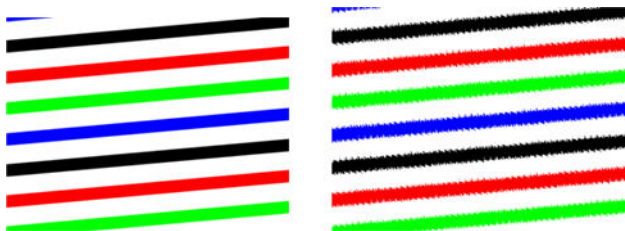

Horizontal periodical banding

This problem can be found in scanners with a defective pressure roll in some CIS modules. In this case, you may sometimes find horizontal periodical bands in your scanned images, separated by around 5 cm (2 in), in the area covered by one CIS module, as in this example: original on the left, scanned image on the right. Please note the black arrow indicating the scanning direction in this example.



Actions

1. Open the scanner lid. Clean the motor wheels (small black rubber) and the pressure rolls (wide white plastic). Check that all the pressure rolls can move freely. If you find dust particles or objects that obstruct the movement of the rollers, try to remove them, then close the scanner lid and repeat your scan.
2. If the problem persists, clean and calibrate the scanner as indicated in [Scanner maintenance on page 154](#), and analyze pattern 1 of the diagnostic plot. If you can find horizontal periodical banding inside this pattern, as shown on the right below, call HP support and report “horizontal periodical banding”. Please note the black arrow indicating the scanning direction in this example.



Original Pattern 1 affected by horizontal periodical banding

Defocus, blurring and fading colors

CIS technology scanners are tuned to work at a fixed focal distance, and they are very sensitive to small variations in the position of the original with respect to the scanner glass plate. If the scanner lid is not properly closed, or if the original has deep wrinkles or texture, you may sometimes find problems as in the following example (on the right), where the scanned image is blurred and colors are faded.



Actions

1. Check the scanner lid sensor by opening the scanner lid and checking that the five CIS modules show blinking red, green and blue lights alternately. If not, reboot the machine and call HP support reporting the error appearing at the front panel. If no error is given in the front panel then report “scanner lid sensor failure”.
2. If all the modules lit up correctly in the previous step, close the scanner lid by pushing it down until you hear a click. Then calibrate the scanner as indicated in [Scanner maintenance on page 154](#) and repeat your scan.
3. If the problem persists, repeat the scan or copy using a higher resolution (High or Max if scanning, Normal or Best if copying). You should also set background cleaning to 0, or set the content type to **Mixed**.

4. If the problem persists, analyze pattern number 7 in modules A through E of the diagnostic plot. A correct example is given below, followed by two incorrect examples. Note that there is a black ring near the center of pattern 7. In this step, you must look at the region near the black ring. If you can see discontinuities in the black and white lines, call HP support and report a “defocus or blurring” error.

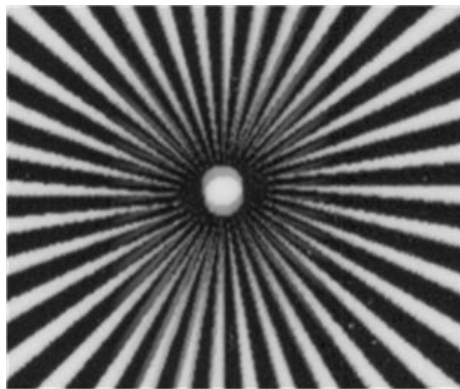
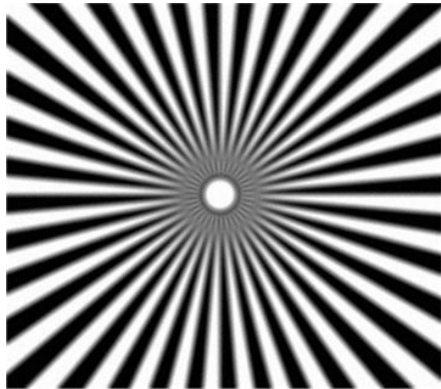
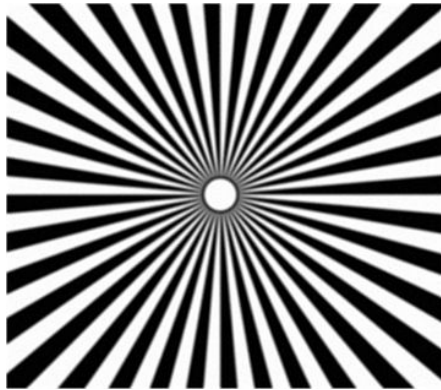

Incorrect paper advance, skew during scanning, or horizontal wrinkles

You may encounter problems with some thick glossy originals being moved through the scanner’s paper path. In some cases, the original may become skewed during the scanning process.

If some of the paper rollers are not working correctly, you may find small horizontal wrinkles in the scanned image, due to the paper being stuck in some regions while not in others.

Actions

1. Turn your original 90 degrees and repeat your scan.
2. If the problem persists, open the scanner lid. Clean the motor wheels (small black rubber) and the pressure rolls (wide white plastic). Check that all the pressure rolls can move freely. If you find dust particles or objects that obstruct the movement of the rollers, try to remove them, then close the scanner lid and repeat your scan.
3. If the problem persists, restart the scanner by turning it off and on again. If you find an error message on the front panel during this operation, call HP support and report the error message. If no error message appears, try repeating your scan.
4. If the problem persists, analyze patterns 4, 13 and 14 of the diagnostic plot. The plot should look like this:



If you see an image resembling the incorrect examples below, call HP support and report an “incorrect paper advance” problem.



Vertical black band 20 cm wide

Your scanner contains various different CIS modules, each of which covers an area 20 cm (7.9 in) wide. If one of the modules fails, and the scanner hardware check does not detect the failure, you may see a black vertical band, corresponding to the area covered by a single CIS module, in your scanned image or copy. Here is an example (on the right). Please note the black arrow indicating the scanning direction in this example.



Original Scan affected by a CIS failing module

Actions

1. Open the lid of the scanner and check that the five CIS modules show blinking red, green and blue lights alternately. If a module is failing, call HP support and report a “CIS module illumination” error.
2. If all the modules lit up correctly in the previous step, restart the scanner by turning it off and on again. If you find an error message on the front panel during this operation, call HP support and report the error message. If no error message appears, try repeating your scan.

3. If the problem persists, try to calibrate the scanner as indicated in [Scanner maintenance on page 154](#). If this operation fails, call HP support with the error code given on the front panel. If no error code appears, try to repeat your scan.
4. If the problem persists, call HP support and report a “vertical black band 20 cm wide”.

The scanner damages some originals

HP is aware that this scanner may cause vertical scratches on inkjet originals on thick glossy paper. Very thin tracing paper or old originals may also be damaged. This is because CIS technology requires the original to be held down with high pressure to obtain accurate results and avoid blurring and defocus problems.

If the original you intend to scan is valuable, and if it belongs to one of the types described above (inkjet-printed, thick, glossy original or old/thin/tracing paper original), HP recommends using a CCD scanner such as the HP DesignJet T1200 HD MFP.

Completely wrong colors

If some of the LEDs used for illumination in the CIS modules are failing, or the last calibration did not work correctly, although no error message was given on the front panel, you may experience some completely wrong colors in your scanned images, as in the example below: original on the left, scanned image on the right.



1. Open the lid of the scanner and check that the five CIS modules show blinking red, green and blue lights alternately. If some module is failing, call HP support and report a “CIS module illumination” error.
2. If all the modules lit up correctly in the previous step, restart the scanner by turning it off and on again. If you find an error message on the front panel during this operation, call HP support and report the error message.
3. If no error message appears on the front panel during the restart process, try to calibrate your scanner, as indicated in [Scanner maintenance on page 154](#), once it is fully functional. If some error message appears on the front panel, call HP support and report the error, adding that you found it after seeing “completely wrong colors in the scanned image”.
4. If calibration succeeded, repeat your scan and check the colors.

5. If the colors are still wrong, analyze the whole diagnostic sheet. Check that you find completely wrong colors in the area corresponding to just one of the CIS modules, as in the following figure. If so, call HP support and report “completely wrong colors after calibration”, and report the letter of the CIS module that is failing (module A at the example).

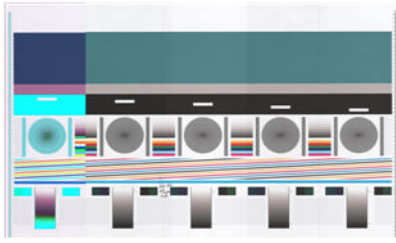

If all the modules are failing, call HP support and report that.

Vertical distortion

If the lid sensor of the scanner fails, the scanner cannot detect when the lid is open. Hence, you can start a scan, and at some point find that the pressure rolls do not move the original through the scanner paper path. You may see images like the following when this happens (original on the left, scanned image on the right). Please note the black arrow indicating the scanning direction in these examples.

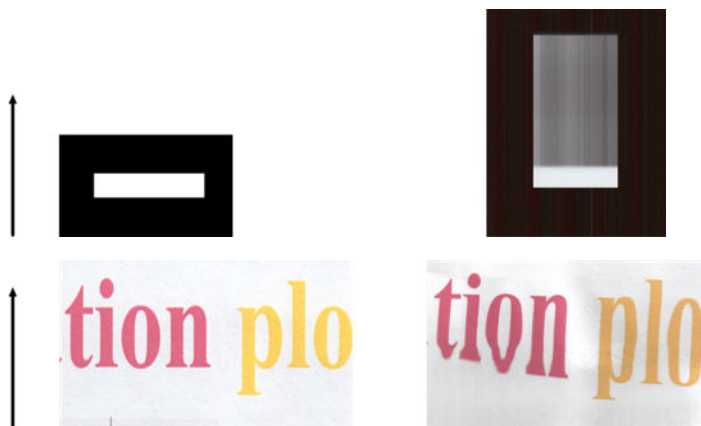

Actions

1. Check that the scanner lid sensor is working by opening the scanner lid and checking that the five CIS modules show blinking red, green and blue lights alternately. If not, call HP support and report “scanner lid sensor failure”.
2. If all the modules lit up correctly in the previous step, close the scanner lid by pushing it down until you hear a click. Then repeat your scan and visually check that the original advances correctly through the scanner path. If not, call HP support and report an “incorrect paper advance” error. Remember that your scanner is not intended to work with originals thicker than 0.75 mm (29 mil).

Object replication (ghosting)

This error very rarely appears in CIS scanners. However, you can occasionally find image defects like the following: original on the left, scanned image on the right.



Image © www.convincingblack.com, reproduced with permission.

Actions

1. Restart your printer. Then calibrate the scanner, as indicated in [Scanner maintenance on page 154](#), and repeat your scan. Turn the original 90 degrees if possible before rescanning.
2. If the problem persists, analyze pattern 3, modules A through E, of the diagnostic plot. Call HP support and report an “object replication” issue if you see the kind of error shown on the right.



Clipping or incorrect scale factor when down-scaling in copies and prints

When doing copies or prints (from USB, Embedded Web Server, or printer driver), the scaling setting is available with various possible options. If you are experiencing problems related to border clipping, or it seems that your print has lost the scale-factor adjustment, please read this section carefully in order to select the best value for the scaling setting in future jobs.

- **Precise scaling:** In this case, the content of the original image is scaled by the percentage factor that you have selected. For example, in an original CAD image with a 1:100 scale, if user selects scale to 50%, the printed plot will have an accurate scale of 1:200. Nevertheless, in the case of down-scalings when selecting a fixed percentage, some clipping of the marginal content of the plot may occur, as it is impossible for the printer to print up to the borders of the paper.
- **Scale to fit into page size:** In this case, the content of the original image is scaled by the percentage necessary to make sure that all the content is correctly printed and no clipping occurs. Nevertheless, in the case of down-scalings when selecting fit to page, the scale-factor adjustment may not be an integer divisor of the original. For example, in an original CAD plot with a 1:100 scale on A2 paper size, if user selects scale to fit on A3 paper size, the scaling factor will not be exactly 50% and the scale of the printed plot will not be 1:200 exactly. However, the plot will be printed completely without clipping any content.

Incorrect edge detection, mostly when scanning tracing paper

Tracing or translucent papers can be scanned with good results, although totally transparent papers are not supported. Nevertheless, the resulting image may have extra margins or some clipping of the content in some situations when detection of the edge of the paper is not accurate, which may also happen when scanning plain paper if the glass plate is dirty. In order to avoid these undesired effects, please follow these recommendations.



Actions

1. Carefully clean the scanner's glass plate and the original to be scanned with a cloth. Turn the original 90 degrees if possible and re-scan it afterwards. Remember to select **Translucent** as the paper type at the scanner if your original is translucent.
2. If the problem persists, please calibrate your scanner, and re-scan your original again afterwards.
3. If the problem persists in the case of translucent paper, attach a sheet of white paper to the back of the original to be scanned. Remember to select **White paper** as the paper type for the scanner in this case.

A copied or scanned image is very skewed

Originals are often loaded into the scanner with some degree of skew. In order to correct for this unavoidable problem, the scanner has a built-in automatic de-skew algorithm, which measures the skew in the original and rotates the scanned image so that the result is perfectly straight. However, in some cases the de-skew algorithm may increase the skew rather than correcting it. In other cases, the skew is so bad that it cannot be automatically corrected.

To load the original with minimum skew, grasp the original with the image facing up and your hands at left and right edges. You are recommended to avoid resting your hands or the original on the scanner's input tray. Push the original into the scanner insertion slot until you feel the whole top border of the original pressing against the scanner rubber rolls, which will load the original after a delay of 0.5 seconds. Now you can take your hands off the original. If you are not happy with the way the scanner has grabbed your original, you can press  and try again.

The action of the automatic de-skew algorithm can be deactivated by pressing , then , then **Scan preferences** or **Copy preferences** (you might want to deactivate it in one case but not in the other). You can also deactivate the automatic de-skew from the **Settings** button at every new scanner job.



24 The scanner diagnostic plot

- [Prepare the printer and the paper to print the diagnostic sheet](#)
- [Visual check for errors while printing the diagnostic sheet](#)
- [Scan or copy the diagnostic plot](#)
- [Monitor calibration](#)
- [Save the diagnostic plot for future use](#)

Prepare the printer and the paper to print the diagnostic sheet

Turn on your printer and wait until it is functioning. Then select the paper on which the diagnostic plot is going to be printed (you can reuse the diagnostic plot any time in the future, if it is saved carefully). Ideally, the diagnostic plot should be printed on glossy paper, and you are highly recommended to do that if you use your printer mostly for scanning or copying photo originals (posters, pictures printed on glossy paper, etc). If you use your printer mostly to scan or copy matte originals, then you can use any matte white paper to print the diagnostic plot. Please do not use recycled or tracing paper to print this plot. The size of the diagnostic plot is 610 × 914 mm (24 × 36 in). It can be printed on any 914 mm (36 in) landscape or 610 mm (24 in) portrait paper roll. You can also use a single sheet that is at least 610 × 914 mm (24 × 36 in).



Once the correct paper is loaded, if this paper permits color calibration then we recommend color-calibrating the printer (see *Using your printer*).

You can print the diagnostic plot from the front panel: press , then , then **Internal prints > Scanner IQ plot** or **Image Quality Maintenance > Scanner IQ plot**.

Visual check for errors while printing the diagnostic sheet

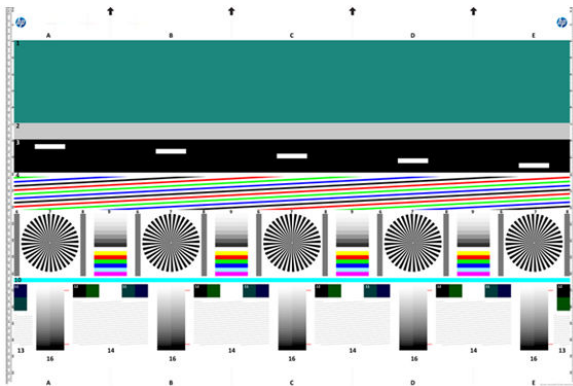
Once the diagnostic plot is printed, the first step is to check that all the patterns included in it are correctly printed. The diagnostic plot, if printed correctly, should look like this:



Some of the most common defects that may appear in a printed diagnostic plot are described below. If you find any of these problems, you should follow the recommended recovery procedure, all of which are available by pressing , then , then **Image Quality Maintenance** at the front panel. Once the printer has been diagnosed and it is working correctly, you can reprint the diagnostic sheet as described in [Prepare the printer and the paper to print the diagnostic sheet on page 220](#).

Resolution

By looking at pattern 7 you may find problems with the printer's resolution for the loaded paper. Usually, this test does not reveal a printer problem, but a defect in the paper, which may not be suitable for printing the diagnostic sheet with the required quality.

Here is what you should see if all is well, followed by two defective examples.

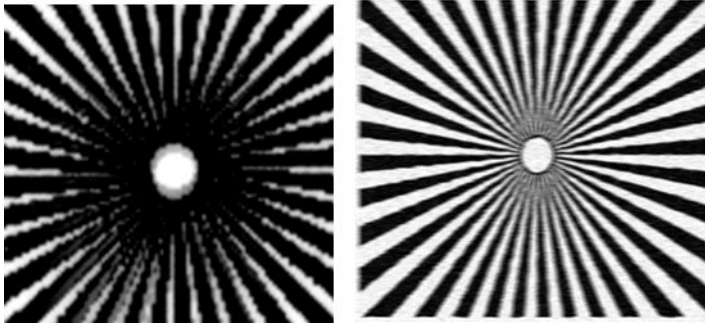
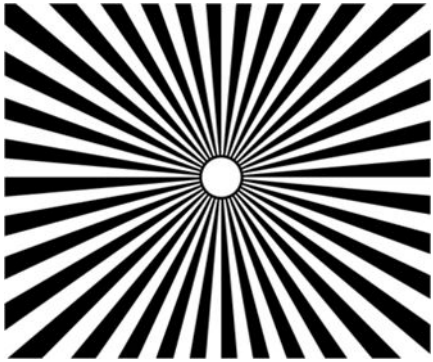

Alignment

Looking at patterns 4, 13, and 14, you may find problems with the printer's printhead alignment, which can cause defects such as the following.

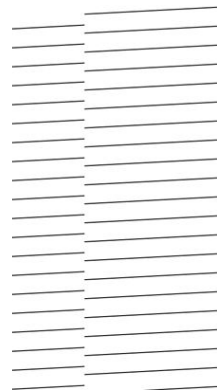

Additionally, misalignment problems can be seen in patterns 4 and 9 in the form of color fringing (which is exaggerated below, on the right). That is, the limits between two strong colors are not well defined or a third color appears between them.

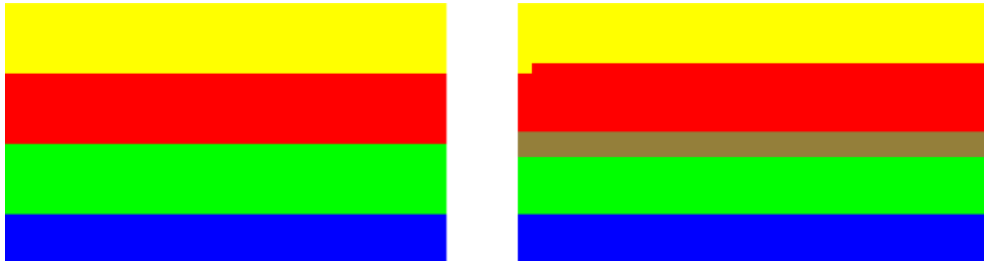



Finally, a special pattern for checking the printer's printhead alignment can be found at the top left of the diagnostic sheet. This pattern has no number as it is not used for scanner checking. It is made of three colored crosses that may be used to identify the problem in question. The correct pattern is shown on the left, an example of misalignment on the right.

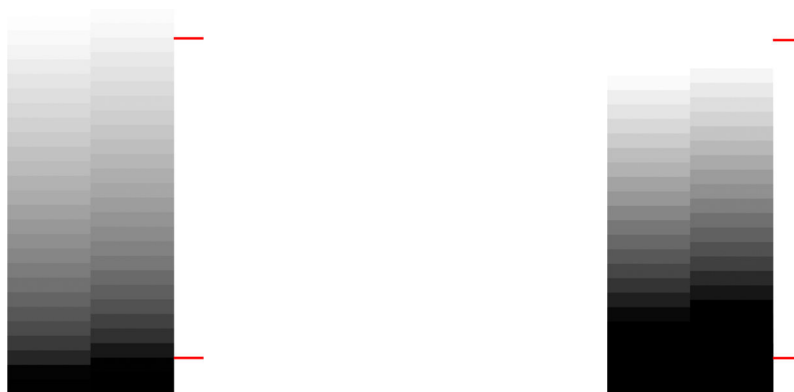

Loss of shadow or highlight details

Looking at pattern 16, you may find a problem with the color calibration of the printer (CLC process). If you can distinguish lightness steps beyond the upper and lower specified thresholds, then the printer is fine. Here you can see examples of correct functioning on the left, incorrect on the right.





If the printer does not pass this test, you should run a color calibration if the paper loaded in the printer can be calibrated (coated or glossy paper, for instance). The color calibration can be launched from the front panel by pressing , then , then **Image Quality Maintenance > Color calibration**.

Printer banding

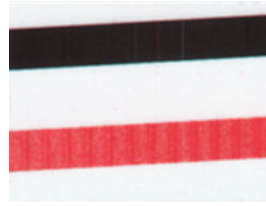
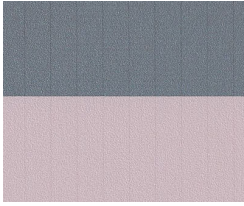
Looking at patterns 1, 2, and 3, you can see vertical banding problems due to a miscalibrated paper advance in the printer.



You can also see some banding in patterns 4, 9, 10, and 11, indicating that the printheads need to be cleaned. You can launch printhead cleaning from the front panel by pressing , then , then **Image Quality Maintenance > Clean printheads**.

Streaks

Looking at patterns 1, 2, 3, 9 and 16, you may find vertical streaks as in the examples shown below, if the printer's printheads are not working correctly. Replacing the printhead for the color showing the streaks may solve the problem.

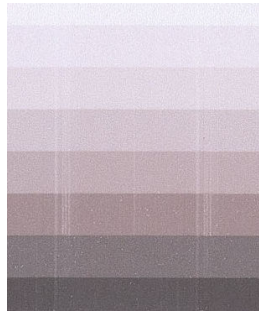

Grain

Looking at patterns 1, 2, and 3, you may find problems in the printer's paper advance or the printheads that cause visible grain in area fills. The following examples show this defect: original on the left, printed image on the right.

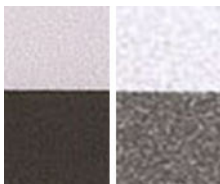
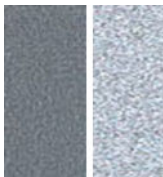

Scan or copy the diagnostic plot

There are two options for evaluating the diagnostic plot: scanning into a JPEG file, or copying onto paper. We recommend using the scan option, so that the generated file can be analyzed more easily by a remote support engineer if necessary. If you decide to scan the plot, first adjust your computer's monitor as described in [Monitor calibration on page 224](#). Once you have scanned the diagnostic plot, please remember to open the scanned file in any image viewer software and select a zoom of 100% for correct visual evaluation of patterns.

If you decide to copy, make sure that a paper roll at least 36 in (914 mm) wide is loaded in the printer. Ideally, the same type of paper used to print the diagnostic plot should be used for copying it.

These are the settings that you should select:

Scan

- Quality: Max
- File type: JPG
- Content type: Image
- Compression: medium
- Paper type: photo or matte, according to the paper used to print the diagnostic plot. Use photo if in doubt.

Copy

- Quality: Best
- Content type: Image
- Paper type: photo or matte, according to the paper used to print the diagnostic plot. Use photo if in doubt.

Load the diagnostic plot into the scanner input tray, making sure that the printed side of the plot is facing up. The black arrows on the diagnostic plot indicate the direction of loading. Make sure that the diagnostic plot is loaded without skew, and it is centered (that is, it covers the whole scanner area).

Once you have scanned the diagnostic plot (in case you selected the scan option), please remember to open the scanned file in any image viewer software and select a zoom of 100% for correct visual evaluation of patterns.

Monitor calibration

The monitor on which the plot is going to be evaluated should ideally be calibrated. As this is not always feasible, we propose here to follow an easy procedure for adjusting the brightness and contrast of the monitor in order to see the patterns correctly.

Adjust the brightness and contrast of your monitor until you can see a difference in lightness between these two squares:



Now you are ready to check each pattern individually.

Save the diagnostic plot for future use

We recommend saving the diagnostic plot with the maintenance sheet, in the solid tube provided.

25 Troubleshooting ink cartridge and printhead issues

- [Cannot insert an ink cartridge](#)
- [Ink cartridge status messages](#)
- [Cannot insert the printhead](#)
- [The front-panel display recommends reseating or replacing the printhead](#)
- [Clean the printhead](#)
- [Align the printhead](#)
- [Printhead status messages](#)

Cannot insert an ink cartridge

1. Check that you have the correct type of cartridge (model number).
2. Check that the colored label on the cartridge is the same color as the label on the slot.
3. Check that the cartridge is correctly oriented, with the letter or letters marking the cartridge label right-side up and readable.

 **CAUTION:** Never clean inside the ink cartridge slots.

Ink cartridge status messages

These are the possible ink cartridge status messages:

- **OK:** The cartridge is working normally, with no known problems.
- **Missing:** There is no cartridge present, or it is not correctly connected to the printer.
- **Low:** The ink level is low.
- **Very low:** The ink level is very low.
- **Empty:** The cartridge is empty.
- **Reset:** You are recommended to remove the cartridge and then reinsert it.
- **Replace:** You are recommended to replace the cartridge with a new cartridge.
- **Expired:** It is past the cartridge's expiration date.
- **Incorrect:** The cartridge is not compatible with this printer. The message includes a list of compatible cartridges.
- **Non-HP:** The cartridge is used, refilled, or counterfeit.

Cannot insert the printhead

1. Check that you have the correct type of printhead (model number).
2. Check that the printhead is correctly oriented.
3. Check that you have correctly closed and latched the printhead cover, see [Insert the printhead on page 145](#).

The front-panel display recommends reseating or replacing the printhead

1. Remove the printhead, see [Remove the printhead on page 141](#).

2. Clean the electrical connections on the backside of the printhead with a lint-free cloth. You can carefully use a mild rubbing alcohol if moisture is needed to remove residue. Do not use water.

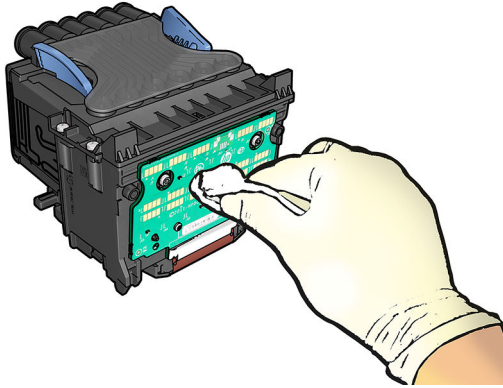

⚠ CAUTION: This is a delicate process and may damage the printhead. Do not touch the nozzles on the bottom side of the printhead, especially not with any alcohol.



3. Reinsert the printhead, see [Insert the printhead on page 145](#).
4. Check the front-panel display message. If the problem remains, try a new printhead.

Clean the printhead

As long as the printer is kept turned on, automatic cleaning is performed periodically. This ensures there is fresh ink in the nozzles and prevents nozzle clogs, thus preserving print quality. If you have print quality problems, please see [The Image Diagnostics Print on page 194](#) before proceeding.

To clean the printhead, go to the front panel and press , then , then **Image Quality Maintenance > Clean printhead**, and select the color group including the color that needs cleaning (**Clean all, Clean MK-Y, Clean C-M-PK-G**).

Align the printhead

Precise printhead alignment is essential for accurate colors, smooth color transitions, and sharp edges in graphical elements. Your printer has an automatic printhead alignment process which runs whenever the printhead has been accessed or replaced.

You may need to align the printhead after a paper jam or if you are experiencing print-quality problems.

1. Load the paper you wish to use, see [Paper handling on page 51](#). You can use a roll or a cut sheet; plain white paper is recommended.

⚠ CAUTION: Do not use transparent or semi-transparent paper to align the printhead.

2. Ensure that the scanner is lowered, as a strong light source near the printer during printhead realignment can affect alignment.
3. From the front panel, press , then **Image Quality Maintenance > Align printhead**.

📄 NOTE: Printhead alignment can also be started from the Embedded Web Server (**Support > Print Quality Troubleshooting**), or from the HP Utility (Windows: **Support > Print Quality Troubleshooting**; Mac OS X: **Information and Print Quality > Align**).

4. If the loaded paper is satisfactory, the printer runs the realignment and prints a realignment pattern.
5. The process takes about five minutes. Wait until the front-panel display shows the process complete before using the printer.

If the printer cannot complete the printhead alignment successfully, you may be asked to clean the printhead and try again.

Printhead status messages

These are the possible printhead status messages:

- **OK:** The printhead is working normally, with no known problems
- **Missing:** There is no printhead present, or it is not correctly installed in the printer.
- **Reseat:** You are recommended to remove the printhead and then reinsert it. If that fails, clean the electrical connections, see [The front-panel display recommends reseating or replacing the printhead on page 227](#). If that fails, replace the printhead with a new printhead, see [Remove the printhead on page 141](#) and [Insert the printhead on page 145](#).
- **Replace:** The printhead is failing. Replace the printhead with a working printhead, see [Remove the printhead on page 141](#) and [Insert the printhead on page 145](#).
- **Replacement incomplete:** The printhead replacement process has not completed successfully; re-launch the replacement process and let it finish completely.
- **Remove:** The printhead is not a suitable type for use in printing.
- **Non-HP ink:** Ink from a used, refilled, or counterfeit ink cartridge has passed through the printhead. See the limited warranty document provided with your printer for details of the warranty implications.

26 Troubleshooting general printer issues

- [The printer will not start](#)
- [The printer does not print](#)
- [The printer seems slow](#)
- [The printer behaves strangely](#)
- [Communication failures between computer and printer](#)
- [Cannot access the HP Utility](#)
- [Cannot access the Embedded Web Server](#)
- [Cannot connect to the Internet](#)
- [Mobile printing troubleshooting](#)
- [Automatic file system check](#)
- [Alerts](#)

The printer will not start

If the printer will not start, you are recommended to replace the firmware, in the following way.

1. Go to the HP Support Center (see [HP Support Center on page 241](#)) and download the firmware.
2. Save the firmware on a USB flash drive. Ideally, the USB flash drive should be empty and formatted with the FAT filesystem.
3. Ensure that the printer is turned off. Connect the USB flash drive to the Hi-Speed USB host port in the front panel, then turn the printer on.

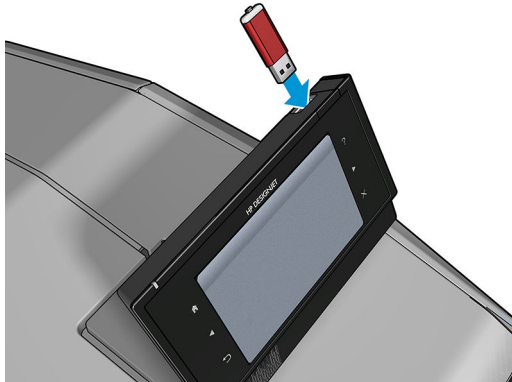

4. The printer takes about a minute to read the firmware file, then asks you to remove the USB flash drive.
5. The printer automatically installs the new firmware and restarts.

The printer does not print

If all is in order (paper loaded, all ink components installed and no file errors), there are still reasons why a file you have sent from your computer may not start printing when expected:

- You may have an electrical power problem. If there is no activity at all from the printer, and the front panel does not respond, check that the power cable is connected correctly and that there is power available at the socket.
- Nesting may be on and the printer is waiting for the specified nest wait time before calculating the appropriate nests. In this case, the front panel shows the remaining time needed for nesting.
- You may have the wrong graphic language setting, see [Change the graphic language setting on page 49](#).
- You may not have installed in your computer the correct driver for your printer, see the *Assembly instructions*.
- If you are printing on a sheet, you must specify Manual Feed as the paper source in your printer driver.
- The printer may be holding the job for paper or accounting information, see [Job status messages on page 101](#).
- You may have requested a print preview from your printer driver. This is a function you can use to check that the image is the one you want. In this case, the preview is displayed on your screen, and you must click the **Print** button to start printing.
- Make sure that you have closed the stacker, unless you are using manual mode.



- If you selected manual mode for the job, you must open the job queue, select the job, and print it in manual mode.
- You may be experiencing unusual electromagnetic phenomena, such as strong electromagnetic fields or severe electrical disturbances, which can cause the printer to behave strangely or even stop working. In this case, turn off the printer using the **Power** key on the front panel and unplug the power cord, wait until the electromagnetic environment has returned to normal, then turn it on again. If you still experience problems, please contact your customer service representative.

The printer seems slow





Here are some possible explanations.

- Did you set the print-quality to **Best** or **Max Detail**? Best-quality and maximum detail prints take longer.
- Did you specify the correct paper type when loading the paper? Some paper types require more time for printing. To find out the printer's current paper type setting, see [View information about the paper on page 63](#).
- Check that all components used in your network (network interface cards, hubs, routers, switches, cables) are capable of high-speed operation. Is there a lot of traffic from other devices on the network?
- Did you specify **Extended** drying time in the front panel? Try changing the drying time to **Optimal**.

The printer behaves strangely

If you are experiencing unexpected behavior from your printer, you can restore most of your printer's settings to their factory default values from the front panel. Press , then , then **Setup > Resets > Restore factory settings**.

This will not reset basic networking settings or network security settings.

- Basic networking settings can be reset by pressing , then , then **Connectivity > Network connectivity > Advanced > Restore factory settings**.
- Network security settings can be reset by pressing , then , then **Connectivity > Network connectivity > Gigabit Ethernet > Modify configuration > Reset Security**.

Communication failures between computer and printer

Some symptoms are:

- The front-panel display does not show the **Receiving** message when you have sent an image to the printer.
- Your computer displays an error message when you are trying to print.
- Your computer or printer hangs (stays idle), while communication is taking place.
- Your printed output shows random or inexplicable errors (misplaced lines, partial graphics etc.)



To solve a communication problem:

- Ensure that you have selected the correct printer in your application, see [Printing on page 69](#).
- Ensure that the printer works correctly when printing from other applications.
- Remember that very large prints may take some time to receive, process and print.
- If your printer is connected to your computer through any other intermediate devices, such as switch boxes, buffer boxes, cable adapters, cable converters, etc., try using it when connected directly to your computer.
- Try another interface cable.
- Ensure that the graphic language setting is correct, see [Change the graphic language setting on page 49](#).

Cannot access the HP Utility

If you have not done so already, please read [Access the HP Utility on page 46](#).

Make sure your printer driver is available and working correctly for the HP DesignJet Utility in Windows.

From the front panel, press , then , then **Connectivity > Network Connectivity > Advanced > Web Services > Printer utility software**, and make sure that it is enabled. If it is disabled, some parts of the HP Utility may not work properly.

Cannot access the Embedded Web Server

If you have not done so already, please read [Access the Embedded Web Server on page 46](#).

From the front panel, press , then , then **Connectivity > Network connectivity > Advanced > Embedded Web Server > Allow EWS > On**.





If you are using a proxy server, try bypassing the server and accessing the Web server directly.

- In Internet Explorer for Windows, go to **Tools > Internet Options > Connections > LAN Settings**, and check the **Bypass proxy server for local addresses** box. Alternatively, for more precise control, click the **Advanced** button and add the printer's IP address to the list of exceptions, for which the proxy server is not used.
- In Safari for Mac OS X, go to **Safari > Preferences > Advanced** and click the **Proxies: Change Settings** button. Add the printer's IP address or its domain name to the list of exceptions, for which the proxy server is not used.



If you still cannot connect, switch the printer off and back on with the **Power** key on the front panel.

Cannot connect to the Internet

If your printer has difficulty in connecting to the Internet, it may start the Connectivity Wizard automatically. You can also start the wizard manually at any time.

- From the front panel: Press , then , then **Connectivity > Connectivity wizard**.
- From the front panel: Press , then , then **Internal prints > Service information prints > Print connectivity config**. In this case, the results are printed out.

 **NOTE:** The results printed out are from the last run of the Connectivity wizard, so you must already have run the Connectivity wizard in order to get any results.

The Connectivity Wizard performs a series of tests automatically. You can also choose to perform individual tests. From the front panel, press , then , then **Connectivity > Diagnostics & troubleshooting**. The following options are available.

- **All tests**
- **Network connectivity test:** Check the printer's connection to the local area network.
- **Internet connectivity test:** Check the printer's connection to the Internet.
- **HP ePrint Center connectivity test:** Check the printer's connection to the HP ePrint Center.
- **Firmware update test:** Check the printer's connection to HP's firmware update servers.
- **Email server test:** Check the printer's connection to the configured email server.
- **Customer Involvement Program test:** Check the printer's connection to the CIP.

Alternatively, these tests can be launched from the Embedded Web Server: select **Support > Connectivity troubleshooting**.

If any test fails, the printer describes the problem and recommends how to solve it.

Mobile printing troubleshooting

For any issues with HP ePrint, please refer to the HP ePrint Center: <http://www.hp.com/go/eprintcenter>.

Automatic file system check

When you turn on the printer, you will occasionally see a front panel display similar to the one shown below.

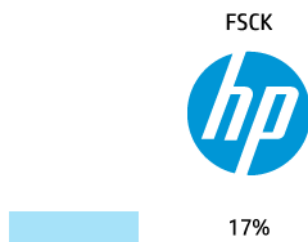

A file system check is taking place; it can take up to 40 minutes. Please wait until it finishes.

 **CAUTION:** If you turn the printer off before the file system check has finished, the file system could be seriously damaged, making the printer's hard disk unusable. In any case, the file system check will restart from the beginning whenever you turn the printer on again.

A file system check is scheduled every 90 days, in order to maintain the hard disk's file system integrity.



NOTE: When the printer is powered back on, it takes about three minutes to initialize and check and prepare the printhead. However, it can take up to 40 under some conditions, for example, when the printer has not been used for a long period of time and requires more time to prepare the printhead.

Alerts

Your printer can communicate two types of alerts:

- **Errors:** Mainly alerting you to the fact that the printer is unable to work normally. However, in the printer driver, errors can also alert you to conditions that could ruin the print, such as clipping, even if the printer is able to print.
- **Warnings:** Alert you when the printer needs attention either for an adjustment, such as a calibration or for a possible unprintable situation, such as a preventive maintenance or low ink.

There are various ways in which you can receive alerts.

- **Front-panel display:** The front panel shows only the most relevant alert at a time. In the case of a warning, it disappears after a timeout. There are permanent alerts, such as "ink cartridge low on ink", that reappear when the printer becomes idle and there is not another more severe alert.



TIP: From the front panel display you can configure paper mismatch alerts, see [Paper suitability options on page 28](#).

- **Embedded Web Server:** The upper-right corner of the Embedded Web Server window shows the printer status. If there is an alert in the printer, the status shows the alert text.
- **HP DesignJet Utility for Windows:** Select **Alert settings** from the HP DesignJet Utility taskbar icon to control the kinds of alerts that will be displayed by default.
- **HP Printer Monitor for Mac OS X:** The HP Printer Monitor shows you alerts directly in the Dock if you installed the HP Utility. If you have not done so already, please read [Turn alerts on and off on page 31](#).

By default, alerts are displayed only when you are printing. If alerts are enabled and there is a problem that prevents a job from completing, you see a pop-up window, which explains the reason for the problem. Follow the instructions to achieve your required result.



NOTE: There are environments that do not support bidirectional communication. In those cases, alerts do not reach the job owner.

27 Front-panel error messages

Occasionally you may see one of the following messages appear on the front-panel display. If so, please follow the advice in the Recommendation column.

If you see an error message that does not appear here, and you feel in doubt about the correct response, or if the recommended action does not seem to solve the problem, first try restarting the printer. If the problem remains, contact HP Support; see [Contact HP Support on page 243](#).

Table 27-1 Text messages

Message	Recommendation
[Color] cartridge altered	Check the cartridge.
[Color] cartridge has expired	Replace the cartridge. See Handling ink cartridges and printhead on page 136 .
[Color] cartridge is low on ink	Ensure that you have a new cartridge of the same color ready.
[Color] cartridge is missing	Insert a cartridge of the correct color. See Handling ink cartridges and printhead on page 136 .
[Color] cartridge is non-HP ink	You are recommended to install an HP original ink system for optimum system performance.
[Color] cartridge is out of ink	Replace the cartridge. See Handling ink cartridges and printhead on page 136 .
[Color] cartridge is very low on ink	Ensure that you have a new cartridge of the same color ready.
Printhead error: not present	Insert a printhead. See Handling ink cartridges and printhead on page 136 .
Printhead error: replace	Remove the non-functional printhead and insert a new printhead. See Handling ink cartridges and printhead on page 136 .
Printhead error: reset	Remove and reinsert the same printhead, or try cleaning the electrical connections. If necessary, insert a new printhead. See The front-panel display recommends reseating or replacing the printhead on page 227 .
Printhead out of warranty	The printhead's warranty has ended, because of the length of time it has been in operation, because of the volume of ink used, or because non-HP ink has been used in the system. See the limited warranty document.
Printhead replacement incomplete. Restart it.	Restart the printhead replacement process.
Replace [color] cartridge	Replace the cartridge. See Handling ink cartridges and printhead on page 136 .

Table 27-1 Text messages (continued)

Message	Recommendation
Replace incorrect [color] cartridge	Replace the cartridge. Check the supported ink cartridges and see Handling ink cartridges and printhead on page 136 .
Reseat [color] cartridge	Remove and reinsert the same cartridge. See Handling ink cartridges and printhead on page 136 .

Table 27-2 Numerical error codes

Error code	Recommendation
05.5:10	Update the printer's BIOS.
08:04	Restart the printer. If the problem persists, update the printer's firmware. See Update the firmware on page 151 .
08:08	Retry the operation that you were attempting. If it fails again, restart the printer. If the problem persists, update the printer's firmware. See Update the firmware on page 151 .
09:01	Paper jam in the scanner. Remove all paper from the scanner and try again.
09:02	Calibrate the scanner. See Calibrate the scanner on page 163 .
09:04	Restart the printer. If the problem persists, update the printer's firmware. See Update the firmware on page 151 .
39.1:01	Roll 1 has been unexpectedly unloaded. Reload the roll.
39.2:01	Roll 2 has been unexpectedly unloaded. Reload the roll.
61:01	The file format is wrong and the printer cannot process the job. <ul style="list-style-type: none"> • Turn off the printer using the Power button at the front. • Turn off the power switch at the rear. • Disconnect the power cord. • Reconnect the power cord and turn on the printer. • Send the same job to the printer again. • Ensure that the printer's firmware is up to date. See Update the firmware on page 151.
61:04.1, 61:04.2	Update your printer's firmware. See Update the firmware on page 151 .
61:08	Resend the job.
61:08.1	The job cannot be printed because it is password-protected.
61:08.2	The job cannot be printed because it contains errors. Resend the job from the Embedded Web Server.
61:09	Resend the job.

Table 27-2 Numerical error codes (continued)

Error code	Recommendation
63:10	<ul style="list-style-type: none">• Turn off the printer using the Power button at the front.• Turn off the power switch at the rear.• Disconnect the power cord.• Reconnect the power cord and turn on the printer.• Check that the network cable is correctly connected.• Ensure that the printer's firmware is up to date. See Update the firmware on page 151.
63:20	<p>A potential problem has been detected in the network interface.</p> <ul style="list-style-type: none">• Turn off the printer using the Power button at the front.• Turn off the power switch at the rear.• Disconnect the power cord.• Reconnect the power cord and turn on the printer.• Send the same job to the printer again.• Ensure that the printer's firmware is up to date. See Update the firmware on page 151.
71.03, 71.08	<p>Out of memory. To avoid this, in the HP-GL/2 driver select the Advanced tab and then Send job as a bitmap.</p>
74.01	<p>An error occurred when loading the firmware update file.</p> <ul style="list-style-type: none">• Turn off the printer using the Power button at the front.• Turn off the power switch at the rear.• Disconnect the power cord.• Reconnect the power cord and turn on the printer.• Reload the firmware update file into the printer. See Update the firmware on page 151.
74.1:04	<p>Try the firmware update again. Do not try to use your computer while the update is in progress.</p>
74.8:04	<p>The firmware update has failed. Your firmware file may be incorrect; try to download it again. See Update the firmware on page 151.</p>
75.11:10	<p>Preventive maintenance 1 is recommended. See Contact HP Support on page 243.</p>
75.21:10	<p>Preventive maintenance 2 is recommended. See Contact HP Support on page 243.</p>
76:03	<p>The printer's hard disk is full. You may want to use Disk Wipe to free some space; see Disk Wipe on page 153.</p>
78:08	<p>Borderless printing not possible; setting ignored. Ensure that the loaded paper supports borderless printing.</p>
79:03, 79:04	<p>Update the printer's firmware. See Update the firmware on page 151.</p>
81:01	<p>Open the scanner and make sure that there are no obstacles restricting the movement of the drive roller. If the paper has jammed, clear the obstruction by following the instructions in the front panel.</p>

Table 27-2 Numerical error codes (continued)

Error code	Recommendation
86:01	Open the scanner and make sure that there are no obstacles restricting the movement of the printhead's carriage. If the paper has jammed, clear the obstruction by following the instructions in the front panel.
94, 94.1	Restart color calibration. See Color calibration on page 104 .

The system error log

The printer saves a log of system errors that you can access in the following ways.

Using a USB flash drive

1. Create an empty file named **pdipu_enable.log** in a USB flash drive.
2. Insert the USB flash drive into the Hi-Speed USB host port in the front panel. The log will be automatically copied into the drive.

Using the Embedded Web Server

1. In your Web browser, go to `http://printer IP address/hp/device/webAccess/log.html`.
2. The Embedded Web Server will send you a file with the extension **.trb** containing the system error log.

Alternatively, select the **Support** tab, then **Service Support** > **Download Diagnostic Package**.

28 HP Customer Care

- [Introduction](#)
- [HP Professional Services](#)
- [HP Proactive Support](#)
- [Customer Self Repair](#)
- [Contact HP Support](#)

Introduction

HP Customer Care offers award-winning support to ensure you get the most from your HP DesignJet, providing comprehensive, proven support expertise and new technologies to give you unique end-to-end support. Services include setup and installation, troubleshooting tools, warranty upgrades, repair and exchange services, phone and Web support, software updates, and self-maintenance services. To find out more about HP Customer Care, please visit us at <http://www.hp.com/go/graphic-arts> or call us on the telephone (see [Contact HP Support on page 243](#)).

 **TIP:** By taking just a few minutes to register, you can improve your experience with HP and enjoy more efficient support. Click <http://register.hp.com/> to start. Also click <http://www.hp.com/go/alerts> to get connected with HP DesignJet updates, including product fixes and enhancements.

HP Professional Services

HP Support Center

Enjoy a world of dedicated services and resources to ensure you always get the best performance from your HP DesignJet printers and solutions.

Join the HP community at the HP Support Center, your large-format printing community, for 24×7 access to:

- Multimedia tutorials
- Step-by-step how-to guides
- Downloads: the latest printer firmware, drivers, software, paper presets, etc.
- Technical support: online troubleshooting, customer care contacts and more
- Workflows and detailed advice for completing various printing tasks from particular software applications
- Forums for direct contact with the experts, both HP and your colleagues
- Warranty tracking online, for your peace of mind
- Latest product information: printers, supplies, accessories, software, etc.
- Supplies Center for all you need to know about ink and paper

The HP Support Center can be found at <http://www.hp.com/go/T2500/support>.

By customizing your registration for the products you have purchased and your type of business, and by setting your communication preferences, you decide the information you need.

HP Start-Up Kit

The HP Start-Up Kit is the DVD that comes with your printer; it contains the printer's software and documentation.

HP Care Packs and Warranty Extensions

HP Care Packs and Warranty Extensions allow you to extend your printer's warranty beyond the standard period.

They include remote support. On-site service is also provided if necessary, with two alternative response-time options.

- Next business day
- Same business day, within four hours (may not be available in all countries)

For more information on HP Care Packs, please visit <http://www.hp.com/go/printservices>.

HP Installation

The HP Installation service unpacks, sets up and connects the printer for you.

This is one of the HP Care Pack services; for more information, please visit <http://www.hp.com/go/printservices>.

HP Proactive Support

HP Proactive Support helps reduce costly printer downtime by preemptively identifying, diagnosing and resolving printer issues before they become problems for you. HP's Proactive Support tool is designed to help businesses of all sizes reduce support costs and maximize productivity—all with the click of a mouse.

A component of the HP Imaging and Printing suite of services, Proactive Support helps you gain control of your printing environment—with a clear focus on maximizing the value of your investment, increasing printer uptime and reducing printer management costs.

HP recommends that you enable Proactive Support right away to save you time and prevent problems before they occur, reducing costly downtime. Proactive Support runs diagnostics and checks for software and firmware updates.

You can enable Proactive Support in the HP DesignJet Utility for Windows or the HP Printer Monitor for Mac OS X, where you can specify the frequency of connections between your computer and HP's Web server, and the frequency of diagnostic checks. You can also choose to run the diagnostic checks at any time. To change these settings:

- In the HP DesignJet Utility for Windows, select the **Tools** menu, then **HP Proactive Support** (not available in HP DesignJet Utility 1.0).
- In the HP Printer Monitor for Mac OS X, select **Preferences > Monitoring > Enable HP Proactive Support**.

If Proactive Support finds any potential problem, it notifies you with an alert, which will explain the problem and recommend a solution. In some cases, the solution may be applied automatically; in other cases, you may be asked to perform some procedure to solve the problem.

Customer Self Repair

HP's Customer Self Repair program offers our customers the fastest service under either warranty or contract. It enables HP to ship replacement parts directly to you (the end user) so that you can replace them. Using this program, you can replace parts at your own convenience.



Convenient, easy to use

- An HP Support Specialist will diagnose and assess whether a replacement part is required to address a defective hardware component.
- Replacement parts are express-shipped; most in-stock parts are shipped the very same day you contact HP.
- Available for most HP products currently under warranty or contract.
- Available in most countries.

For more information about Customer Self Repair, see <http://www.hp.com/go/selfrepair>.

Contact HP Support

HP Support is available to you by telephone or instant messaging. What to do before you call:

- Review the troubleshooting suggestions in this guide.
- Review the relevant driver documentation.
- If you have installed third-party software drivers and RIPs, see their documentation.
- If you call one of the HP offices, please have the following information available to help us answer your questions more quickly:
 - The product you are using (the product number and the serial number, found on the label at the back of the product)
 - If there is an error code on the front panel, note it down; see [Front-panel error messages on page 236](#)
 - The product's Service ID: at the front panel, press , then , then  .
 - The computer you are using
 - Any special equipment or software you are using (for example, spoolers, networks, switch-boxes, modems or special software drivers)
 - The cable you are using (by part number) and where you purchased it
 - The software name and version you are currently using
 - If possible, print out the following reports from the front panel; you may be asked to fax or email them to the support center helping you: Configuration, Usage Report and "all pages above" from Service Information (see [The printer's internal prints on page 13](#)). Alternatively, in the Embedded Web Server, go to **Support > Service support > Printer information > All pages**.

How to contact HP Support

You can review latest information related to your product and get chat assistance at <http://www.hp.com/go/getsupport>.

You can also get chat assistance on your smartphone by using the HP Support Center Mobile App: http://www8.hp.com/us/en/products/smart-phones-handhelds-calculators/mobile-apps/app_details.html?app=tc:245-1163163&platform=tc:245-1163164.

Your HP Support telephone number is available on the Web: please visit http://welcome.hp.com/country/us/en/wwcontact_us.html.

29 Printer specifications

- [Functional specifications](#)
- [Mobile printing specifications](#)
- [Physical specifications](#)
- [Memory specifications](#)
- [Power specifications](#)
- [Environmental specifications](#)
- [Acoustic specifications](#)

Functional specifications

Table 29-1 HP 727 ink supplies

Printhead	One printhead, with doubled nozzles for matte black
Ink cartridges	Cartridges containing 40 ml of ink: gray, photo black, matte black, yellow, magenta, and cyan Cartridges containing 130 ml of ink: gray, photo black, matte black, yellow, magenta, and cyan

Table 29-2 Paper sizes

	Minimum	Maximum
Roll width	279 mm (11 in)	914 mm (36 in)
Roll length		91 m (300 ft)
Roll diameter		140 mm (5.51 in)
Roll weight		11.9 kg (26.3 lb)
Sheet width	210 mm (8.26 in)	914 mm (36 in)
Sheet length	279 mm (11 in)	1676 mm (66 in)
Sheet width (scanner)		914 mm (36 in)
Sheet length (scanner)		15 m (49.21 ft) at 200dpi, TIFF file format and 24 in width
Roll paper thickness		0.5 mm (19.7 mil*)
Sheet paper thickness		0.5 mm (19.7 mil*)
Paper weight	60 g/m ²	328 g/m ²

* up to 0.6 mm printed to the output stacking tray with manual mode

Table 29-3 Printing resolutions

Print quality	Maximum detail	Graphic language	Rendering resolution (ppi)	Printing resolution (dpi)
Best (photo paper*)	On	HP-GL/2, HP PCL3GUI	1200 × 1200	2400 × 1200
		PostScript	600 × 600	2400 × 1200
	Off	any	600 × 600	1200 × 1200
Best (other papers)	Off	any	600 × 600	1200 × 1200
Normal	Off	HP-GL/2	600 × 600	1200 × 1200
		HP PCL3GUI, PostScript	300 × 300	1200 × 1200

Table 29-3 Printing resolutions (continued)

Print quality	Maximum detail	Graphic language	Rendering resolution (ppi)	Printing resolution (dpi)
Fast (heavyweight coated, photo)	Off	HP-GL/2	600 × 600	1200 × 1200
		HP PCL3GUI, PostScript	300 × 300	1200 × 1200
Fast (plain, coated, natural tracing paper)	Off	HP-GL/2	600 × 600	600 × 1200
		HP PCL3GUI, PostScript	300 × 300	600 × 1200
Economode	Off	any	300 × 300	600 × 1200

* For a list of supported papers, see [Order paper on page 166](#).

Scanner resolutions: 200, 300, 600 ppi.

Table 29-4 Margins

Top, right and left margins	5 mm (0.2 in)
Bottom margin (trailing edge)	5 mm (0.2 in) (roll)
	22 mm (0.87 in) (sheet)

Table 29-5 Mechanical accuracy

±0.1% of the specified vector length or ±0.2 mm (whichever is greater) at 23°C (73°F), 50-60% relative humidity, on E/A0 printing material in Best or Normal mode with HP Matte Film roll feed.

Table 29-6 Graphic languages supported

HP DesignJet	Languages
T2500	HP PCL3GUI, HP-GL/2 and HP RTL, CALS G4, TIFF, JPEG, URF
T2500 PS	HP PCL3GUI, HP-GL/2 and HP RTL, CALS G4, TIFF, JPEG, URF, Adobe PDF 1.7, Adobe PostScript 3
Scanner	TIFF, JPEG, PDF

Mobile printing specifications

Table 29-7 Mobile printing

Mobile printing	Yes, directly from both iOS with AirPrint and Android with HP Print Service Plugin
Mobile devices supported by HP Mobile printing	Smartphones and tablets
Supported operating systems	iOS, Android, Windows
OS Versions	iOS from 7.0 and Android from 4.4, Windows any
Connectivity requirements	Printer and mobile device must use the same network
Supported file formats	PDF, JPEG

Table 29-8 Email printing

Mobile devices supported	Smartphones, tablets, PC
Supported operating systems	Any, as long as it has email
Connectivity requirements	Cloud connection
Cloud features	Remote printing through email
Supported file formats	PDF, JPEG, TIFF
Max file size	10 MB

Physical specifications

Table 29-9 Printer physical specifications

Weight	109 kg (240 lb)
Width	1399 mm (55.08 in)
Depth	916 mm (36.1 in) (stacker and basket open) 693 mm (27.3 in) (stacker and basket closed)
Height	1110 mm (43.7 in) (stacker and front panel deployed) 950 mm (37.4 in) (stacker and front panel folded)

Memory specifications

Table 29-10 Memory specifications

HP DesignJet	Physical DRAM	Virtual file-processing memory	Hard disk
T2500 series	1.5 GB	128 GB	320 GB
T2530 series	1.5 GB	128 GB	500 GB

Power specifications

Table 29-11 Printer power specifications

Source	100–240 V ac \pm 10%, auto-ranging
Frequency	50–60 Hz
Current	< 4.2 A
Consumption	< 330 W

Environmental specifications

Table 29-12 Printer environmental specifications

Operating temperature	5 to 40°C (41 to 104°F)
Recommended operating temperature	15 to 35°C (59 to 95°F), depending on paper type
Storage temperature	–25 to 55°C (–13 to 131°F)
Recommended operating humidity	20 to 80% RH, depending on paper type
Storage humidity	0 to 95% RH

Acoustic specifications

Printer acoustic specifications (declared according to ISO 9296).

Table 29-13 Printer acoustic specifications

The printer is...	Sound power level B(A)	Sound pressure level dB(A)
Sleeping	< 1.9	16
Ready	5.8	39.2
Printing	6.5	46.9

Glossary

AirPrint

A technology used by iPod, iPhone, iPad, and (optionally) Mac OS X 10.7 onwards, which allows immediate printing to a printer in the same network without the need for a printer-specific driver.

AppleTalk

A suite of protocols that Apple Computer developed in 1984 for computer networking. Apple now recommends TCP/IP and Bonjour networking instead. HP DesignJet printers no longer support AppleTalk.

Bonjour

Apple Computer's trade name for its implementation of the IETF Zeroconf specification framework, a computer network technology used in Apple's Mac OS X from version 10.2 onwards. It is used to discover services available on a local area network. It was originally known as Rendezvous.

Color accuracy

The ability to print colors that match the original image as closely as possible, bearing in mind that all devices have a limited color gamut and may not be physically capable of matching certain colors precisely.

Color consistency

The ability to print the same colors from a particular print job from print to print and from printer to printer.

Color model

A system of representing colors by numbers, such as RGB or CMYK.

Color space

A color model in which each color is represented by a specific set of numbers. Many different color spaces can use the same color model: for instance, monitors generally use the RGB color model, but they have different color spaces, because a particular set of RGB numbers results in different colors on different monitors.

Cutter

A printer component that slides back and forth across the platen to cut the paper.

ESD

ElectroStatic Discharge. Static electricity is common in daily life. It is the spark when touching the car door, or the cling of clothing. Although controlled static electricity has some useful applications, uncontrolled electrostatic discharges are one of the main hazards to electronic products. Therefore, to prevent damage some precautions are needed when setting up the printer, or handling ESD sensitive devices. This type of damage may reduce the life expectancy of the device. One way to minimize uncontrolled ESDs, and therefore reduce this type of damage is by touching any exposed grounded part of the printer (mainly metal parts) before handling ESD sensitive devices (such as the printhead or ink cartridges). Additionally, to reduce the generation of electrostatic charge in your body try to avoid working in a carpeted area, and keep your body movements to a minimum when handling ESD sensitive devices. Also, avoid working in low humidity environments.

Ethernet

A popular computer networking technology for local area networks.

Fast Ethernet

An Ethernet network capable of transferring data at up to 100,000,000 bits/second. Fast Ethernet interfaces are capable of negotiating slower speeds when required for compatibility with older Ethernet devices.

Firmware

Software that controls your printer's functionality and is stored semi-permanently in the printer (it can be updated).

Gamut

The range of colors and density values reproducible on an output device, such as a printer or monitor.

Gigabit Ethernet

An Ethernet network capable of transferring data at up to 1,000,000,000 bits/second. Gigabit Ethernet interfaces are capable of negotiating slower speeds when required for compatibility with older Ethernet devices.

Hi-Speed USB

A version of USB, sometimes called USB 2.0, that can run 40 times faster than original USB, but is otherwise compatible with original USB. Most personal computers today use Hi-Speed USB.

HP RTL

HP Raster Transfer Language: a language defined by HP to describe raster (bitmap) graphics.

HP-GL/2

HP Graphics Language 2: a language defined by HP to describe vector graphics.

I/O

Input/Output: this term describes the passing of data between one device and another.

ICC

The International Color Consortium, a group of companies that have agreed on a common standard for color profiles.

Ink cartridge

A removable printer component that stores ink of a particular color and provides it to the printhead.

IP address

May mean an IPv4 address (most likely) or an IPv6 address.

IPSec

A sophisticated mechanism for providing network security by authenticating and encrypting IP packets sent between nodes on a network. Each network node (computer or device) has an IPSec configuration. Applications are usually unaware whether IPSec is being used or not.

IPv4 address

A unique identifier that identifies a particular node on an IPv4 network. An IPv4 address consists of four integers separated by full stops. Most networks in the world use IPv4 addresses.

IPv6 address

A unique identifier that identifies a particular node on an IPv6 network. An IPv6 address consists of up to 8 groups of hexadecimal digits separated by colons. Each group contains up to 4 hexadecimal digits. Only a few new networks in the world use IPv6 addresses.

LED

Light-Emitting Diode: a semiconductor device that emits light when electrically stimulated.

MAC address

Media Access Control address: a unique identifier used to identify a particular device on a network. It is a lower-level identifier than the IP address. Thus, a device may have both a MAC address and an IP address.

Network

A network is a set of connections that pass data between computers and devices. Every device is able to communicate with every other device in the same network. This allows data to be moved between computers and devices, and allows devices such as printers to be shared between many computers.

Nozzle

One of many tiny holes in a printhead through which ink is deposited onto the paper.

Paper

A thin, flat material made to be written or printed on; most commonly made from fibers of some kind which are pulped, dried and pressed.

Platen

The flat surface within the printer over which the paper passes while it is being printed on.

Printer driver

Software that converts a print job in a generalized format into data suitable for a particular printer.

Printhead

A removable printer component that takes ink of one or more colors from the corresponding ink cartridge(s) and deposits it on the paper, through a cluster of nozzles.

Spindle

A rod that supports a roll of paper while it is being used for printing.

TCP/IP

Transmission Control Protocol/Internet Protocol: the communications protocols on which the Internet is based.

USB

Universal Serial Bus: a standard serial bus designed to connect devices to computers. Your printer supports Hi-Speed USB (sometimes called USB 2.0).

USB device port

A square USB socket found on USB devices, through which a computer can control the device. For a computer to print to your printer using a USB connection, the computer must be connected to the printer's USB device port.

USB host port

A rectangular USB socket such as those on found on computers. A printer can control USB devices that are connected to such a port. Your printer has two USB host ports, which it uses to control accessories and USB flash drives.

Index

A

- access control 32
- accessories
 - order 167
- account ID
 - requiring 33
- accounting 133
- accounting data by email 134
- acoustic specifications 249
- Acrobat, print from 116
- alerts
 - errors 235
 - turn on and off 31
 - warnings 235
- Android 94
- auto-off 47
- AutoCAD, print from 118

B

- banding problems 182
- basket 63
 - output problems 177
- black and white 108
- black point compensation 113
- blurred lines 186
- brightness in front panel 48

C

- calibration
 - color 104
 - scanner 163
- cannot load paper 169
- clean the printer 150
- clipped at bottom 192
- clipped image 193
- color
 - adjustment options 107
 - advantages 104
 - calibration 104

CMYK 104

- emulation 110
- fading 192
- inaccurate 191
- printer emulation 107
- profile 104
- RGB 104

color management

- from drivers 106
- from EWS 112
- from front panel 113
- from PS drivers 109
- options 106
- process 104
- scanner 113

communication ports 8

- components of printer 6
- computer communication
 - printer/computer
 - communications issues 232

configure 48

- connect the printer
 - general 16
 - Mac OS X network 18
 - Windows network 17

crop lines 81

- Customer Care 241
- Customer Self Repair 242
- cutter
 - on/off 66

D

- DHCP settings 40
- disk wipe 153
- DNS settings 41
- draft printing 78
- driver preferences 34
- drying time
 - change 65

E

- e-mail notifications 31
- economize
 - on ink 83
 - on paper 81
- Email printing 248
- Embedded Web Server
 - access 46
 - cannot access 233
 - job preview 100
 - job queue 99
 - language 47
 - usage per job 133
 - usage statistics 133
- environmental specifications 249
- erase files securely 153
- error messages
 - front panel 236
 - log 239

F

- fading colors 192
- features of printer 5
- file erase, secure 153
- file system check 234
- firewall status 42
- firmware update 151
 - manual setup 22
 - setup 21
- front panel 8
 - brightness 48
 - job preview 96
 - job queue 96
 - language 46
 - units 48
- front panel option
 - adjust paper advance 182
 - align printhead 228
 - allow EWS 233

- auto-off 47
 - black point compensation 113
 - calibrate color 105
 - calibrate paper advance 182
 - calibration status 105
 - clean printhead 228
 - CMYK source profile 113
 - color/grayscale 113
 - connectivity wizard 21, 233
 - cutter 66
 - display brightness 48
 - drying time 65
 - economode 79
 - emulate printer 113
 - enable crop lines 81
 - form feed and cut 66
 - Internet connectivity 21
 - language 46
 - maximum detail 79
 - merge 78
 - modify configuration 49
 - move paper 65
 - nest options 29
 - PANTONE emulation 113
 - paper mismatch action 28
 - paper size 74
 - print connectivity config. 233
 - print diagnostic image 194
 - print quality 74
 - printer utility software 233
 - printhead information 140
 - printing paper info 64
 - rendering intent 113
 - replace ink cartridges 137
 - replace printhead 141
 - reset paper advance 183
 - resize 77
 - retrieval time 65
 - RGB source profile 113
 - roll protection 83
 - roll switching options 29
 - select graphics language 50
 - sleep mode wait time 47
 - speaker volume 48
 - unit selection 48
 - unload paper 58
 - wait time 83
 - front view 6
 - FTP folder
 - configure 23
 - functional specifications 246
- G**
- graininess 187
 - graphic languages 247
 - gray shades 108
- H**
- hard disk specification 248
 - HP Care Packs 241
 - HP Connected
 - disable 33
 - HP Customer Care 241
 - HP Installation 242
 - HP Proactive Support 242
 - HP Start-Up Kit 241
 - HP Start-Up Kit DVD 3
 - HP Support 243
 - HP Support Center 241
 - HP Utility
 - access 46
 - cannot access 233
 - language 47
 - HP-GL/2 49
- I**
- image diagnostics print 194
 - image problems
 - clipped at bottom 192
 - clipped image 193
 - missing objects 193
 - PDF problems 194
 - ink
 - economical use of 83
 - usage 133
 - ink cartridge
 - about 137
 - cannot insert 227
 - insert 138
 - maintenance 150
 - order 166
 - remove 137
 - specification 246
 - status 137
 - status messages 227
 - internal prints 13
 - Internet connection
 - manual setup 21
 - setup 21
 - troubleshooting 233
 - IP address 40, 47
- iPad** 94
- iPod Touch** 94
- IPSec** 17
- IPSEC status** 42
- IPv6** 16
- IPV6 settings** 41
- J**
- job preview
 - Embedded Web Server 100
 - front panel 96
 - job queue
 - Embedded Web Server 99
 - front panel 96
- L**
- language 46
 - line length accuracy 187
 - line thickness 184
 - link speed 43
 - load paper
 - cannot load 169
 - general advice 52
 - paper not in list 170
 - roll cannot load 169
 - roll into printer 55
 - roll onto spindle 52
 - sheet 59
 - sheet cannot load 169
 - loading paper problems 169
 - loudspeaker volume 48
- M**
- maintenance kits 152
 - margins 76
 - none 80
 - specification 247
 - maximum detail 79
 - mechanical accuracy 247
 - memory specifications 248
 - Microsoft Office, print from 125
 - misaligned colors 185
 - Mobile printing 94, 248
 - introduction 12
 - print 92
 - mobile printing troubleshooting 234
 - mobile specifications 248
 - models, printer 4
 - monitor
 - calibrate 224

- more passes 79
- move the printer 150
- multiroll printer 67
- N**
- nesting 81
 - turn on and off 29
- network configuration 35
- network folder
 - cannot access 198
 - configure 23
 - use 87
- Network settings 48
- network troubleshooting 37
- networks
 - link speed 43
 - protocols 39
 - security settings 42
- O**
- on hold for paper
 - enable/disable 172
 - message 171
- order
 - accessories 167
 - ink cartridges 166
 - paper 166
 - printhead 166
- overlapping lines 77
- overnight printing 84
- P**
- page size 74
- PANTONE emulation 109
- paper
 - advance 66
 - calibrate the paper advance 182
 - cannot load 169
 - displaying information 64
 - download presets 64
 - economical use of 81
 - feed and cut 66
 - incorrect out of paper 177
 - jam in platen 173
 - jam in stacker 177
 - loading error messages 169
 - maintenance 65
 - movement 65
 - not cut well 178
 - not flat 188
 - output problems in basket 177
 - paper not in list 170
 - presets 64
 - print on loaded paper 76, 171
 - printed on wrong paper 171
 - retained by printer 178
 - roll loose on spindle 178
 - select type 76
 - size 74
 - sizes (max and min) 246
 - stacker unexpectedly full 177
 - usage 133
 - view information 63
- paper mismatch action 28
- paper not in list 170
- paper suitability 28
- paper types 166
- PDF clipped 194
- PDF missing objects 194
- Photoshop, print from 123
- physical specifications 248
- ports 8
- PostScript upgrade 167
- power
 - on/off 13
- power specifications 249
- preferences, Windows driver 34
- preview a print 78
- print from
 - Embedded Web Server 71
 - HP Utility 71
 - printer driver 73
 - USB flash drive 70
- Print from in-OS 94
- print from iOS with AirPrint 84
- print from mobile 92
- print job
 - nesting 81
- print preview 78
- print quality
 - select 73
- print-quality problems
 - banding 183
 - black ink comes off 190
 - blurred lines 186
 - bottom of print 191
 - discontinuous lines 186
 - edges darker than expected 190
 - edges stepped or not sharp 190
 - general 181
 - graininess 187
 - horizontal lines 183
 - inaccurate line lengths 187
 - ink marks 189
 - line thickness 184
 - misaligned colors 185
 - paper not flat 188
 - scratching 188
 - scuffing 188
 - stepped lines 185
 - vertical bands of different colors 191
 - white spots 191
 - wizard 181
- printer does not print 231
- printer email address, change 50
- printer models 4
- printer security 50
- printer software 11
 - Mac OS X uninstall 19
 - Windows uninstall 18
- printer status 150
- printer will not start 231
- printer's main components 6
- printer's main features 5
- printhead
 - about 140
 - align 228
 - cannot insert 227
 - clean; purge 228
 - insert 145
 - order 166
 - remove 141
 - replace, reseal 227
 - specification 246
 - status 140
 - status messages 229
- printhead cleaner
 - specification 246
- printing 69
- printing resolutions 246
- Proactive Support 242
- protect a roll 83
- protocols, network 39
- Proxy Server settings 42
- Q**
- quality, high 79
- R**
- rear view 7

- remote printing
 - set preferences 22
 - rendering intent 112
 - rescale a print 77
 - retrieval time
 - change 65
 - roll paper
 - load 55
 - spindle load 52
 - unload 58
 - roll protection 83
 - roll switching options 29
- S**
- safe mode 140
 - safety precautions 2
 - scale a print 77
 - scan-quality problems
 - color differences between CIS modules 204
 - color fringing 207
 - completely wrong colors 215
 - damaged original 215
 - down-scaling 217
 - edge detection 218
 - flare from glossy originals 209
 - ghosting 216
 - grain in area fills 203
 - horizontal periodical banding 211
 - inaccurate colors 206
 - line discontinuities 202
 - out of focus 212
 - paper advance 213
 - random vertical lines 201
 - shadow/highlight clipping 208
 - stop-start effect 210
 - too much skew 218
 - variable line thickness 206
 - vertical black band 20 cm wide 214
 - vertical distortion 216
 - vertical lines between CIS modules 205
 - vertical red/green bands 209
 - vibration effect 211
 - wrinkles or folds 201
 - scanner
 - calibration 163
 - can't access network folder 198
 - clean glass plate 155
 - diagnostic plot 219
 - replace glass plate 158
 - scan to file 87
 - slow scan 198
 - supported paper types 86
 - scratched prints 188
 - scuffed prints 188
 - secure file erase 153
 - security 32
 - network settings 42
 - sheet paper
 - load 59
 - sleep mode 11
 - sleep mode wait time 47
 - slow printing 232
 - software 11
 - software update 152
 - specifications
 - acoustic 249
 - email printing 248
 - environmental 249
 - functional 246
 - graphic languages 247
 - hard disk 248
 - ink supplies 246
 - margins 247
 - mechanical accuracy 247
 - memory 248
 - mobile 248
 - mobile printing 248
 - paper size 246
 - physical 248
 - power 249
 - printing resolutions 246
 - spindle 167
 - roll load 52
 - spindle adaptor kit 167
 - stacker 60
 - statistics
 - ink cartridge 137
 - usage 133
 - usage per job 133
 - stepped lines 185
 - store the printer 150
 - support services
 - HP Care Packs 241
 - HP Customer Care 241
 - HP Proactive Support 242
 - HP Start-Up Kit 241
 - HP Support 243
 - HP Support Center 241
 - printer installation 242
 - warranty extensions 241
- T**
- TCP/IP settings 39
 - telephone number 244
 - two rolls 67
- U**
- unattended printing 84
 - unload paper
 - roll 58
 - usage information
 - turn on and off 30
 - using this guide 3
- V**
- volume control 48
- W**
- warranty extensions 241
 - Web services
 - setup 21