



LASERJET PRO MFP

## User Guide



M521





# HP LaserJet Pro MFP M521

User Guide

## Copyright and License

© 2014 Copyright Hewlett-Packard Development Company, L.P.

Reproduction, adaptation, or translation without prior written permission is prohibited, except as allowed under the copyright laws.

The information contained herein is subject to change without notice.

The only warranties for HP products and services are set forth in the express warranty statements accompanying such products and services. Nothing herein should be construed as constituting an additional warranty. HP shall not be liable for technical or editorial errors or omissions contained herein.

Edition 1, 10/2014

Part number: A8P80-91069

## Trademark Credits

Adobe®, Acrobat®, and PostScript® are trademarks of Adobe Systems Incorporated.

Apple and the Apple logo are trademarks of Apple Computer, Inc., registered in the U.S. and other countries. iPod is a trademark of Apple Computer, Inc. iPod is for legal or rightholder-authorized copying only. Don't steal music.

Bluetooth is a trademark owned by its proprietor and used by Hewlett-Packard Company under license.

Microsoft®, Windows®, Windows® XP, and Windows Vista® are U.S. registered trademarks of Microsoft Corporation.

UNIX® is a registered trademark of The Open Group.

---

# Table of contents

<b>1 Product introduction .....</b>	<b>1</b>
Product comparison .....	2
Product views .....	4
Product front view .....	4
Product back view .....	5
Interface ports .....	6
Serial number and model number location .....	7
Control panel .....	8
Control-panel layout .....	8
Control-panel Home screen .....	9
Control panel help system .....	10
Print product reports .....	11
<b>2 Paper trays .....</b>	<b>13</b>
Supported paper sizes .....	14
Supported paper types .....	16
Tray 1 .....	17
Tray capacity and paper orientation .....	17
Load Tray 1 .....	18
Tray 2 and optional Tray 3 .....	20
Tray capacity and paper orientation .....	20
Load Tray 2 and optional Tray 3 .....	21
Use paper output options .....	23
Print to the standard output bin .....	23
Print to the rear output bin .....	23
<b>3 Parts, supplies, and accessories .....</b>	<b>25</b>
Order parts, accessories, and supplies .....	26
HP policy on non-HP supplies .....	27
HP anticounterfeit Web site .....	28
Print when a toner cartridge is at estimated end of life .....	29

Enable or disable the Very Low Setting .....	29
Customer self-repair parts .....	31
Accessories .....	33
Toner cartridge .....	34
Toner-cartridge view .....	34
Toner-cartridge information .....	35
Recycle the toner cartridge .....	35
Toner-cartridge storage .....	35
HP policy on non-HP toner cartridges .....	35
Replace the toner cartridge .....	36

#### **4 Print .....** **39**

Supported print drivers (Windows) .....	40
HP Universal Print Driver (UPD) .....	40
UPD installation modes .....	41
Change print-job settings (Windows) .....	42
Priority for changing print-job settings .....	42
Change the settings for all print jobs until the software program is closed .....	42
Change the default settings for all print jobs .....	43
Change the product configuration settings .....	43
Change print-job settings (Mac OS X) .....	44
Priority for changing print-job settings .....	44
Change the settings for all print jobs until the software program is closed .....	44
Change the default settings for all print jobs .....	44
Change the product configuration settings .....	45
Print tasks (Windows) .....	46
Use a printing shortcut (Windows) .....	46
Create printing shortcuts (Windows) .....	48
Automatically print on both sides (Windows) .....	51
Manually print on both sides (Windows) .....	53
Print multiple pages per sheet (Windows) .....	57
Select the page orientation (Windows) .....	59
Select the paper type (Windows) .....	61
Print the first or last page on different paper (Windows) .....	64
Scale a document to fit page size (Windows) .....	67
Create a booklet (Windows) .....	69
Select the paper size (Windows) .....	70
Select a custom paper size (Windows) .....	70
Print watermarks (Windows) .....	71
Cancel a print job (Windows) .....	72
Print tasks (Mac OS X) .....	73

Use a printing preset (Mac OS X) .....	73
Create a printing preset (Mac OS X) .....	73
Automatically print on both sides (Mac OS X) .....	74
Manually print on both sides (Mac OS X) .....	75
Print multiple pages per sheet (Mac OS X) .....	75
Select the page orientation (Mac OS X) .....	75
Select the paper type (Mac OS X) .....	76
Print a cover page (Mac OS X) .....	76
Scale a document to fit page size (Mac OS X) .....	76
Create a booklet (Mac OS X) .....	76
Select the paper size (Mac OS X) .....	77
Select a custom paper size (Mac OS X) .....	77
Print watermarks (Mac OS X) .....	77
Cancel a print job (Mac OS X) .....	78
Create archival-quality prints .....	79
Use HP ePrint .....	80
Use AirPrint .....	81
Use walk-up USB printing .....	82

## **5 Copy .....** **83**

Set new default copy settings .....	84
Restore copy default settings .....	85
Make a single copy .....	86
Make multiple copies .....	87
Copy a multiple-page original .....	88
Copy identification cards .....	89
Collate a copy job .....	90
Copy on both sides (duplex) .....	91
Copy on both sides automatically .....	91
Copy on both sides manually .....	92
Reduce or enlarge a copy .....	93
Optimize copy quality .....	94
Adjust the lightness or darkness for copies .....	95
Copy in draft mode .....	96
Set the paper size and type for copying on special paper .....	97

## **6 Scan .....** **99**

Scan by using the HP Scan software (Windows) .....	100
Scan by using the HP Scan software (Mac OS X) .....	101
Scan to a USB flash drive .....	102
Set up scan to network folder and scan to email features .....	103

Configure the scan to network folder feature .....	103
Configure the scan to email feature .....	103
Scan to a network folder .....	105
Scan to email .....	106
Scan by using other software .....	107
Scan from a TWAIN-compliant program (Windows) .....	107
Scan from a WIA-compliant program (Windows) .....	107

## **7 Fax ..... 109**

Set up the product for fax .....	110
Connect the fax port to a telephone line .....	110
Connect additional devices .....	110
Set up fax with a telephone answering machine .....	111
Set up fax with an extension phone .....	112
Set up for stand-alone fax .....	113
Configure the fax time, date, and header .....	113
Use the control panel to set the fax time, date, and header .....	113
Use the HP Fax Setup Wizard to set the fax time, date, and header (Windows) .....	114
Use the phone book .....	115
Create and edit speed-dial entries .....	115
Create and edit group-dial entries .....	115
Delete speed-dial entries .....	116
Delete group-dial entries .....	116
Configure send fax settings .....	117
Set special dialing symbols and options .....	117
Set a dialing prefix .....	117
Set the dial tone detection .....	118
Tone dial or pulse dial .....	118
Set autoreodial options .....	118
Set light/dark and resolution .....	119
Set the default light/dark (contrast) setting .....	119
Set resolution settings .....	119
Set billing codes .....	120
Configure receive fax settings .....	122
Set fax forwarding .....	122
Set the answer mode .....	122
Block or unblock fax numbers .....	123
Set the number of rings-to-answer .....	123
Set distinctive ring .....	124
Use autoreduction for incoming faxes .....	125



Set fax reprint settings .....	125
Set the fax sounds volume .....	126
Set the alarm volume, phone-line volume, and ring volume .....	126
Set stamp-received faxes .....	126
Set the private receive feature .....	126
Set fax polling .....	127
Use fax .....	128
Supported fax programs .....	128
Cancel a fax .....	128
Cancel the current fax .....	128
Cancel a pending fax job .....	129
Delete faxes from memory .....	129
Use fax on a DSL, PBX, or ISDN system .....	129
DSL .....	129
PBX .....	130
ISDN .....	130
Use fax on a VoIP service .....	130
Fax memory contents are retained when there is a loss of power .....	130
Security issues when connecting internal networks to public phone lines .....	131
Fax from the flatbed scanner .....	131
Fax from the document feeder .....	132
Use speed dials and group-dial entries .....	133
Send a fax from the software (Windows) .....	133
Send a fax by dialing from a telephone connected to the fax line .....	134
Send a fax with confirmation .....	134
Schedule a fax to be sent later .....	135
Send a fax combining an electronic and paper document .....	135
Use access codes, credit cards, or calling cards .....	136
Send faxes internationally .....	136
Print a fax .....	137
Reprint a fax .....	138
Automatically print on both sides of received faxes .....	139
Print a stored fax when the private receive feature is on .....	139
Receive faxes when fax tones are audible on the phone line .....	139

## **8 Manage and maintain ..... 141**

Use the HP Reconfiguration Utility to change the product connection (Windows) .....	142
Set up HP Wireless Direct Printing .....	143
Use HP Web Services applications .....	144
Configure IP network settings .....	145
Printer sharing disclaimer .....	145

View or change network settings .....	145
Manually configure IPv4 TCP/IP parameters from the control panel .....	145
Rename the product on a network .....	146
Link speed and duplex settings .....	147
HP Device Toolbox (Windows) .....	148
HP Utility for Mac OS X .....	150
Open HP Utility .....	150
HP Utility features .....	150
Use HP Web Jetadmin software .....	151
Economy settings .....	152
Print with EconoMode .....	152
Set the Sleep Delay .....	152
Set the Auto Power Down delay .....	152
Product security features .....	154
Lock the product .....	154
Set or change the product password .....	154
Upgrade the firmware .....	155
Manually upgrade the firmware .....	155
Set the product to automatically upgrade the firmware .....	155
<b>9 Solve problems .....</b>	<b>157</b>
Solve problems checklist .....	158
Step 1: Make sure that the product is set up correctly .....	158
Step 2: Check the cabling or wireless connection .....	158
Step 3: Check the control panel for error messages .....	159
Step 4: Check the paper .....	159
Step 5: Check the software .....	159
Step 6: Test print functionality .....	159
Step 7: Test copy functionality .....	160
Step 8: Test the fax functionality .....	160
Step 9: Check the toner cartridge .....	160
Step 10: Try sending a print job from a computer .....	160
Step 11: Verify that the product is on the network .....	160
Restore the factory-set defaults .....	161
Control panel help system .....	162
Paper feeds incorrectly or becomes jammed .....	163
The product does not pick up paper .....	163
The product picks up multiple sheets of paper .....	163
The document feeder jams, skews, or picks up multiple sheets of paper .....	164
Prevent paper jams from the paper trays .....	164
Clear jams .....	165

Jam locations .....	165
Clear jams in the document feeder .....	166
Clear jams in the output area .....	168
Clear jams in Tray 1 .....	170
Clear jams in Tray 2 or optional Tray 3 .....	173
Clear jams in the fuser .....	177
Clear jams in the duplexer .....	179
Improve print quality .....	181
Print from a different software program .....	181
Set the paper-type setting for the print job .....	181
Check the paper-type setting (Windows) .....	181
Check the paper-type setting (Mac OS X) .....	182
Check the toner-cartridge status .....	182
Print a cleaning page .....	182
Visually inspect the toner cartridge .....	183
Check the paper and printing environment .....	183
Use paper that meets HP specifications .....	183
Check the product environment .....	183
Check the EconoMode settings .....	184
Try a different print driver .....	184
Improve copy quality .....	186
Check the scanner glass for dirt and smudges .....	186
Check the paper settings .....	187
Optimize for text or pictures .....	187
Edge-to-edge copying .....	188
Clean the pickup rollers and separation pad in the document feeder .....	188
Improve scan quality .....	190
Check the scanner glass for dirt and smudges .....	190
Clean the pickup rollers and separation pad in the document feeder .....	191
Improve fax quality .....	193
Check the scanner glass for dirt and smudges .....	193
Check the send-fax resolution setting .....	194
Check the error correction setting .....	195
Send to a different fax machine .....	195
Clean the pickup rollers and separation pad in the document feeder .....	195
Check the fit-to-page setting .....	196
Check the sender's fax machine .....	196
The product does not print or it prints slowly .....	197
The product does not print .....	197
The product prints slowly .....	198
Solve walk-up USB printing problems .....	199

The USB Flash Drive menu does not open when you insert the USB flash drive .....	199
The file does not print from the USB flash drive .....	199
The file that you want to print is not listed in the USB Flash Drive menu .....	200
Solve fax problems .....	201
Checklist for solving fax problems .....	201
Perform a fax diagnostic test .....	202
Fax trace report .....	203
Fax error report printing .....	203
Print all fax reports .....	203
Print individual fax reports .....	203
Set the fax error report .....	204
Set the fax-error-correction mode .....	204
Change the fax speed .....	204
Solve problems sending faxes .....	205
An error message displays on the control panel .....	205
The Communication error message appears .....	205
No dial tone .....	206
The Fax is busy message appears .....	206
The No fax answer message appears .....	207
Document feeder paper jam .....	207
The Fax storage is full message appears .....	208
Scanner error .....	208
The control panel displays a Ready message with no attempt to send the fax ..	208
The control panel displays the message "Storing page 1" and does not progress beyond that message .....	209
Faxes can be received, but not sent .....	209
Product is password protected .....	209
Unable to use fax functions from the control panel .....	209
Unable to use speed dials .....	210
Unable to use group dials .....	210
Receive a recorded error message from the phone company when trying to send a fax .....	210
Unable to send a fax when a phone is connected to the product .....	211
Solve problems receiving faxes .....	211
The fax does not respond .....	211
The fax has a dedicated phone line .....	211
An answering machine is connected to the product .....	212
The Answer Mode setting is set to the Manual setting .....	212
Voice mail is available on the fax line .....	213
The product is connected to a DSL phone service .....	213
The product uses a fax over IP or VoIP phone service .....	213

An error message displays on the control panel .....	214
The No fax detected. message displays .....	214
The Communication error message appears .....	214
The Fax storage is full message appears .....	215
The Fax is busy message appears .....	215
A fax is received but does not print .....	216
The Private Receive feature is on .....	216
Sender receives a busy signal .....	216
A handset is connected to the product .....	216
A phone line splitter is being used .....	216
No dial tone .....	216
Cannot send or receive a fax on a PBX line .....	216
Solve general fax problems .....	217
Faxes are sending slowly .....	217
Fax quality is poor .....	218
Fax cuts off or prints on two pages .....	218
Solve USB connection problems .....	220
Solve wired network problems .....	221
Poor physical connection .....	221
The computer is using the incorrect IP address for the product .....	221
The computer is unable to communicate with the product .....	222
The product is using incorrect link and duplex settings for the network .....	222
New software programs might be causing compatibility problems .....	222
The computer or workstation might be set up incorrectly .....	222
The product is disabled, or other network settings are incorrect .....	222
Solve wireless network problems .....	223
Wireless connectivity checklist .....	223
The product does not print after the wireless configuration completes .....	224
The product does not print, and the computer has a third-party firewall installed .....	224
The wireless connection does not work after moving the wireless router or product .....	224
Cannot connect more computers to the wireless product .....	224
The wireless product loses communication when connected to a VPN .....	225
The network does not appear in the wireless networks list .....	225
The wireless network is not functioning .....	225
Perform a wireless network diagnostic test .....	226
Reduce interference on a wireless network .....	226
Solve product software problems with Windows .....	227
A print driver for the product is not visible in the Printer folder .....	227
An error message was displayed during the software installation .....	227
The product is in Ready mode, but nothing prints .....	227
Solve product software problems with Mac OS X .....	229

The print driver is not listed in the Print & Fax or Print & Scan list .....	229
The product name does not appear in the product list in the Print & Fax or Print & Scan list .....	229
The print driver does not automatically set up the selected product in the Print & Fax or Print & Scan list .....	229
A print job was not sent to the product that you wanted .....	230
When connected with a USB cable, the product does not appear in the Print & Fax or Print & Scan list after the driver is selected. ....	230
You are using a generic print driver when using a USB connection .....	230
Remove software (Windows) .....	231
Remove software (Mac OS X) .....	232
Solve scan to email problems .....	233
Cannot connect to the email server .....	233
The email failed .....	233
Unable to scan .....	233
Solve scan to network folder problems .....	234
The scan failed .....	234

**Index .....** 235

---

# 1 Product introduction

- [Product comparison](#)
- [Product views](#)
- [Control panel](#)
- [Print product reports](#)

# Product comparison

		<b>M521dn</b>	<b>M521dw</b>
		<b>A8P79A</b>	<b>A8P80A</b>
<b>Paper handling</b>	Tray 1 (100-sheet capacity)	✓	✓
	Tray 2 (500-sheet capacity)	✓	✓
	Optional Tray 3 (500-sheet capacity)	✓	✓
	Standard output bin (250-sheet capacity)	✓	✓
	Rear output bin (50-sheet capacity)	✓	✓
	Automatic duplex printing	✓	✓
<b>Supported operating systems</b>	Windows XP, 32-bit, Service Pack 2 and greater	✓	✓
	Windows Vista, 32-bit and 64-bit	✓	✓
	Windows 7, 32-bit and 64-bit	✓	✓
	Windows 2003 Server (32-bit, Service Pack 1 or greater), print and scan drivers only	✓	✓
	Windows 2008 Server (32-bit, 64-bit, and R2), print and scan drivers only	✓	✓
	Mac OS X v10.6.8 and later	✓	✓
<b>Connectivity</b>	Hi-Speed USB 2.0	✓	✓
	10/100/1000 Ethernet LAN connection	✓	✓
	Wireless network connection		✓
<b>Memory</b>	256 MB RAM	✓	✓
<b>Control-panel display</b>	Color graphical touch screen	✓	✓
<b>Print</b>	Prints 40 pages per minute (ppm) on A4-size paper and 42 ppm on Letter-size paper	✓	✓
	Walk-up USB printing (no computer required)	✓	✓



		<b>M521dn</b>	<b>M521dw</b>
		<b>A8P79A</b>	<b>A8P80A</b>
<b>Copy</b>	Copies at up to 20 ppm	✓	✓
	Copy resolution is 300 dots per inch (dpi)	✓	✓
	This document feeder holds up to 50 pages and supports page sizes from 127 to 356 mm (5 to 14 in) in length and from 127 to 216 mm (5 to 8.5 in) in width	✓	✓
	Flatbed scanner supports page sizes up to 297 mm (11.7 in) in length and up to 215 mm (8.5 in) in width	✓	✓
	Automatic duplex copying	✓	✓
<b>Scan</b>	Scans in black and white with resolution up to 1200 dpi from the flatbed glass	✓	✓
	Scans in color with resolution up to 300 dpi from the document feeder and up to 600 dpi from the flatbed glass		
	Automatic duplex scanning	✓	✓
	Scan to Email (no software required)	✓	✓
	Scan to Network Folder (no software required)	✓	✓
	Walk-up USB scanning (no computer required)	✓	✓
<b>Fax</b>	V.34 with two RJ-11 fax ports	✓	✓

# Product views

- [Product front view](#)
- [Product back view](#)
- [Interface ports](#)
- [Serial number and model number location](#)

## Product front view

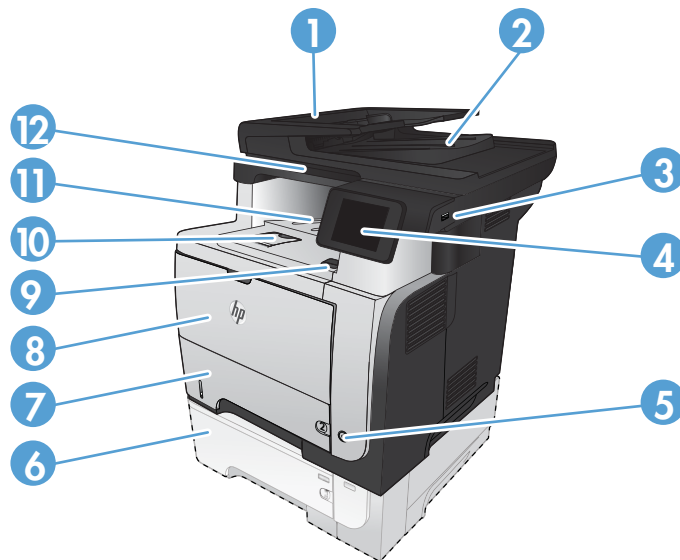

1	Automatic document feeder
2	Document-feeder output bin
3	Walk-up USB port (for printing and scanning without a computer)
4	Control panel with color touchscreen graphical display
5	On/off button
6	Optional Tray 3
7	Tray 2
8	Tray 1
9	Front-door-release button (access to the toner cartridge)
10	Output-bin extension for long paper
11	Standard output bin
12	Handle to raise the scanner lid

## Product back view

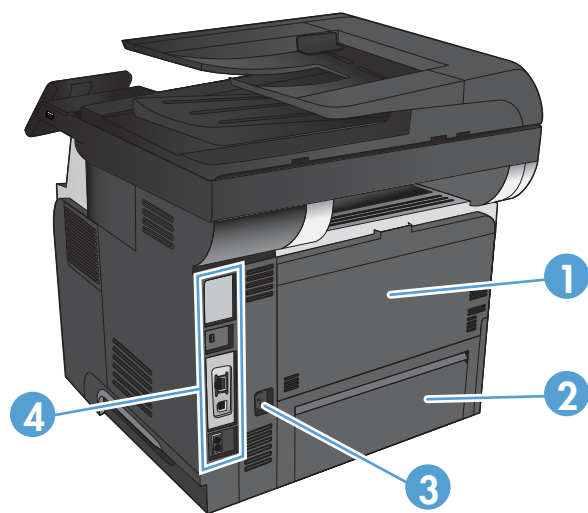

1	Rear door and face-up output bin (access for clearing jams)
2	Dust cover for Tray 2 (for printing on legal-size paper)
3	Power connection
4	I/O ports and security lock

## Interface ports



1	Slot for a cable-type security lock
2	Local area network (LAN) Ethernet (RJ-45) network port
3	Hi-Speed USB 2.0 printing port
4	Telephone "line out" port for attaching an extension phone, answering machine, or other device
5	Fax "line in" port for attaching the fax phone line to the product

## Serial number and model number location

The model number and serial number are listed on an identification label located on the back of the product. They are also listed on the inside of the front door. The serial number contains information about the country/region of origin, the product version, production code, and the production number of the product.

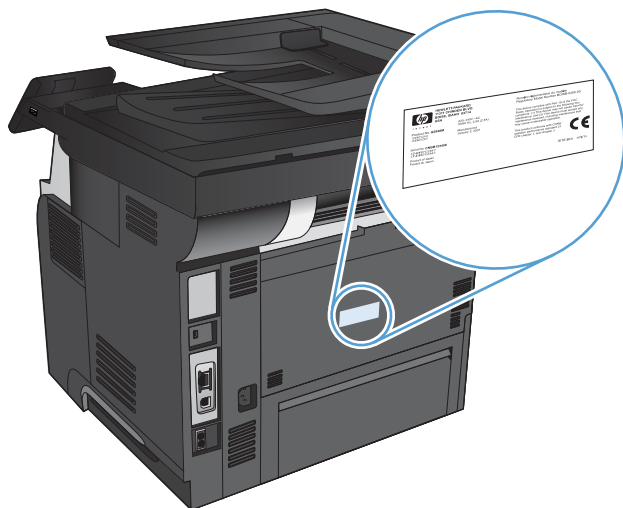

<b>Model name</b>	<b>Model number</b>
M521dn	A8P79A
M521dw	A8P80A

# Control panel

- [Control-panel layout](#)
- [Control-panel Home screen](#)
- [Control panel help system](#)

## Control-panel layout

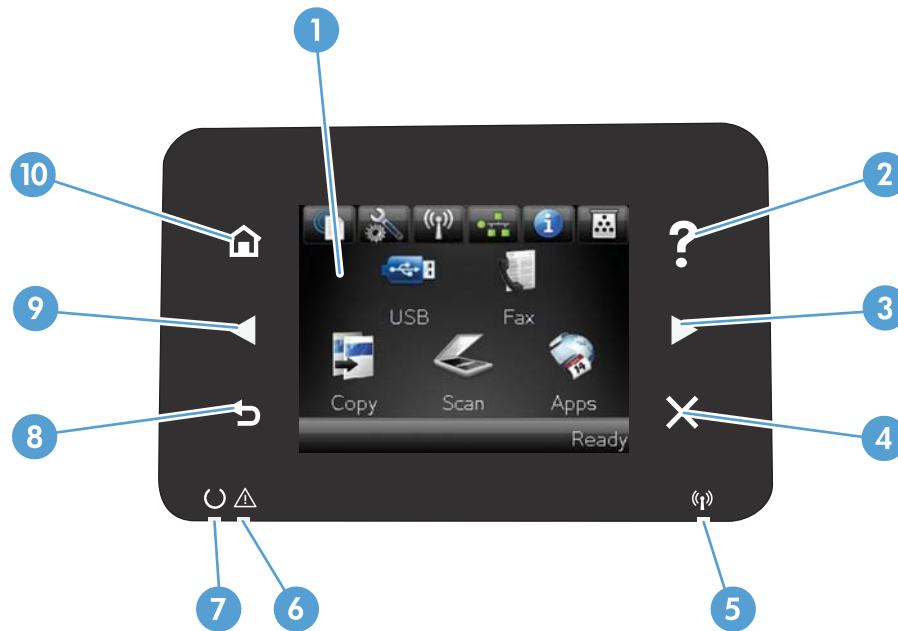

1	Touchscreen display	Provides access to the product features and indicates the current status of the product
2	Help button and light	Provides access to the control-panel help system
3	Right arrow button and light	Moves the cursor to the right or moves the display image to the next screen <b>NOTE:</b> This button illuminates only when the current screen can use this feature.
4	Cancel button and light	Clears settings, cancels the current job, or exits the current screen <b>NOTE:</b> This button illuminates only when the current screen can use this feature.
5	Wireless light (wireless models only)	Indicates the wireless network is enabled. The light blinks while the product is establishing a connection to the wireless network.
6	Attention light	Indicates a problem with the product
7	Ready light	Indicates the product is ready
8	Back button and light	Returns to the previous screen <b>NOTE:</b> This button illuminates only when the current screen can use this feature.





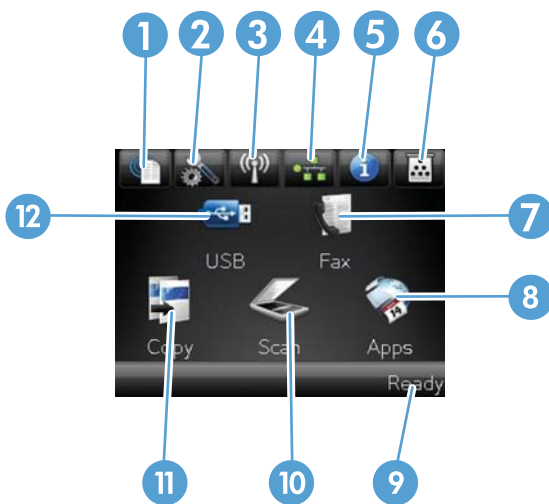

9	Left arrow button and light	Moves the cursor to the left  <b>NOTE:</b> This button illuminates only when the current screen can use this feature.
10	Home button and light	Provides access to the Home screen  <b>NOTE:</b> This button illuminates only when the current screen can use this feature.

## Control-panel Home screen

The Home screen provides access to the product features, and it indicates the product status.

 **NOTE:** Depending on the product configuration, the features on the Home screen can vary. The layout might also be reversed for some languages.



1	Web Services  button	Provides quick access to HP Web Services features, including HP ePrint  HP ePrint is a tool that prints documents by using any email enabled device to send them to the product's email address.
2	Setup  button	Provides access to the main menus
3	Wireless  button (wireless models only)	Provides access to the Wireless menu and wireless status information  <b>NOTE:</b> When you are connected to a wireless network, this icon changes to a set of signal strength bars.
4	Network  button (for products connected to a network only)	Provides access to network settings and information. From the network settings screen, you can print the <a href="#">Network Summary</a> page.
5	Information  button	Provides product status information. From the status summary screen, you can print the <a href="#">Configuration Report</a> page.
6	Supplies  button	Provides information about supplies status. From the supplies summary screen, you can print the <a href="#">Supplies Status</a> page.
7	Fax button	Provides access to the <a href="#">Fax</a> feature

8	Apps button	Provides access to the Apps menu to print directly from Web applications that you have downloaded from the HP ePrintCenter Web site at <a href="http://www.hpeprintcenter.com">www.hpeprintcenter.com</a>
9	Product status	Indicates whether the product is ready or is processing a job
10	Scan button	Provides access to the scan feature
11	Copy button	Provides access to the copy feature
12	USB button	Provides access to the walkup-USB feature (for printing and scanning without a computer)

## Control panel help system

The product has a built-in Help system that explains how to use each screen. To open the Help system, touch the Help ? button in the upper-right corner of the screen.

For some screens, the Help opens to a global menu where you can search for specific topics. You can browse through the menu structure by touching the buttons in the menu.

Some Help screens include animations that guide you through procedures, such as clearing jams.

For screens that contain settings for individual jobs, the Help opens to a topic that explains the options for that screen.

If the product alerts you of an error or warning, touch the Help ? button to open a message that describes the problem. The message also contains instructions to help solve the problem.



# Print product reports

From the [Reports](#) menu, you can print several informative pages about the product.

1. From the Home screen on the product control panel, touch the Setup  button.
2. Touch the [Reports](#) button.
3. Touch the name of the report that you want to print.

Menu item	Description
<a href="#">Demo Page</a>	Prints a page that demonstrates print quality
<a href="#">Menu Structure</a>	Prints a map of the control panel-menu layout. The active settings for each menu are listed.
<a href="#">Configuration Report</a>	Prints a list of all the product settings. Includes network information when the product is connected to a network.
<a href="#">Supplies Status</a>	Prints the status for each toner cartridge, including the following information: <ul style="list-style-type: none"><li>• Estimated percentage of cartridge life remaining</li><li>• Approximate pages remaining</li><li>• Part numbers for HP toner cartridges</li><li>• Number of pages printed</li></ul>
<a href="#">Network Summary</a>	Prints a list of all product network settings
<a href="#">Usage Page</a>	Prints a page that lists PCL pages, PCL 6 pages, PS pages, pages that were jammed or mispicked in the product, number of pages printed; and reports the page count
<a href="#">PCL Font List</a>	Prints a list of all the PCL fonts that are installed
<a href="#">PS Font List</a>	Prints a list of all the PostScript (PS) fonts that are installed
<a href="#">PCL6 Font List</a>	Prints a list of all the PCL6 fonts that are installed
<a href="#">Service Page</a>	Prints the service report
<a href="#">Print Quality Page</a>	Prints a page that helps solve problems with print quality



---

## 2 Paper trays

- [Supported paper sizes](#)
- [Supported paper types](#)
- [Tray 1](#)
- [Tray 2 and optional Tray 3](#)
- [Use paper output options](#)

# Supported paper sizes



**NOTE:** To obtain the best results, select the correct paper size and type in the print driver before printing.

**Table 2-1 Supported paper sizes**

Size and dimensions	Tray 1	Tray 2 and the optional 500-sheet trays	Automatic duplex printing
Letter 216 x 279 mm (8.5 x 11 in)	✓	✓	✓
Legal 216 x 356 mm (8.5 x 14 in)	✓	✓	✓
Executive 184 x 267 mm (7.25 x 10.5 in)	✓	✓	
8.5 x 13 in 216 x 330 mm (8.5 x 13 in)	✓	✓	✓
A4 210 x 297 mm (8.3 x 11.7 in)	✓	✓	✓
A5 148 x 210 mm (5.8 x 8.3 in)	✓	✓	
A6 104 x 148 mm (4.1 x 5.8 in)	✓	✓	
B5 (JIS) 182 x 257 mm (7.2 x 10.1 in)	✓	✓	
16K 184 x 260 mm (7.2 x 10.25 in)	✓	✓	
16K 197 x 273 mm (7.75 x 10.75 in)	✓	✓	
Postcard (JIS) 100 x 148 mm (3.9 x 5.8 in)	✓		
Double Postcard (JIS) 200 x 148 mm (7.9 x 5.8 in)	✓	✓	
Custom 76 x 127 mm to 216 x 356 mm (3.0 x 5.0 in to 8.5 x 14 in)	✓		

**Table 2-1 Supported paper sizes (continued)**

<b>Size and dimensions</b>	<b>Tray 1</b>	<b>Tray 2 and the optional 500-sheet trays</b>	<b>Automatic duplex printing</b>
Custom 105 x 148 mm to 216 x 356 mm (4.1 x 5.8 in to 8.5 x 14 in)		✓	
Custom 210 x 280 mm to 216 x 356 mm (8.3 x 11 in to 8.5 x 14 in)			✓
Envelope #10 105 x 241 mm (4.1 x 9.5 in)	✓		
Envelope DL 110 x 220 mm (4.3 x 8.7 in)	✓		
Envelope C5 162 x 229 mm (6.4 x 9.8 in)	✓		
Envelope B5 176 x 250 mm (6.9 x 9.8 in)	✓		
Envelope Monarch 98 x 191 mm (3.9 x 7.5 in)	✓		

# Supported paper types

For a complete list of specific HP-brand paper that this product supports, go to [www.hp.com/support/ljmfpm521series](http://www.hp.com/support/ljmfpm521series).



**NOTE:** To obtain the best results, select the correct paper size and type in the print driver before printing.

**Table 2-2 Supported paper types**

Paper type	Tray 1	Tray 2 and optional 500-sheet trays	Automatic duplex printing
Plain	✓	✓	✓
HP EcoSMART	✓	✓	✓
Light 60–74g	✓	✓	✓
Midweight 96–110g	✓	✓	✓
Heavy 111–130g	✓	✓	
Extra Heavy 131–175g	✓		
Transparency	✓	✓	✓
Labels	✓		
Letterhead	✓	✓	✓
Envelope	✓		
Preprinted	✓	✓	✓
Prepunched	✓	✓	✓
Colored	✓	✓	✓
Bond	✓	✓	✓
Recycled	✓	✓	✓
Rough	✓	✓	

# Tray 1

- [Tray capacity and paper orientation](#)
- [Load Tray 1](#)

## Tray capacity and paper orientation

To prevent jams, do not overfill trays. Be sure the top of the stack is below the tray-full indicator. For short/narrow and heavy/glossy paper, load paper to less than half of the tray full indicators.

**Table 2-3 Tray 1 capacity**

Paper type	Specifications	Quantity
Paper	Range: 60 g/m <sup>2</sup> (16 lb) to 220 g/m <sup>2</sup> (58 lb)	Maximum stack height: 12 mm (0.5 in) Equivalent to 100 sheets of 75 g/m <sup>2</sup> (20 lb)
Envelopes	75 g/m <sup>2</sup> (20 lb) to 90 g/m <sup>2</sup> (24 lb)	Up to 10 envelopes
Labels	0.10 to 0.14 mm (0.004 to 0.006 in) thick	Maximum stack height: 12 mm (0.5 in)
Transparencies	0.10 to 0.14 mm (0.004 to 0.006 in) thick	Maximum stack height: 12 mm (0.5 in)

**Table 2-4 Tray 1 paper orientation**

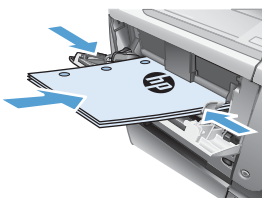
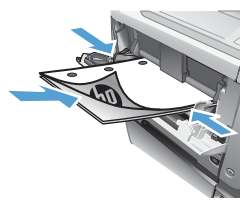
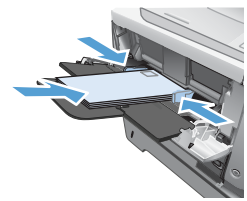
Single-sided printing	Automatic duplex printing and Alternative Letterhead Mode	Envelopes
Face-up Top edge leading into the product	Face-down Bottom edge leading into the product	Face-up Short, postage end leading into the product
		

## Load Tray 1

1. Open Tray 1.

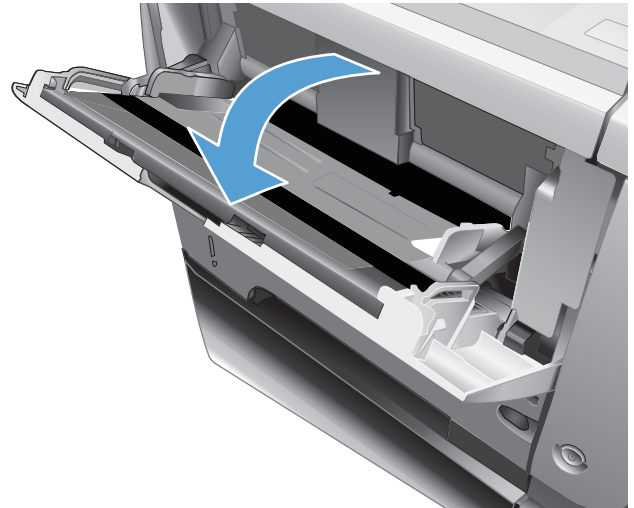

2. Pull out the paper support and fold out the extension.

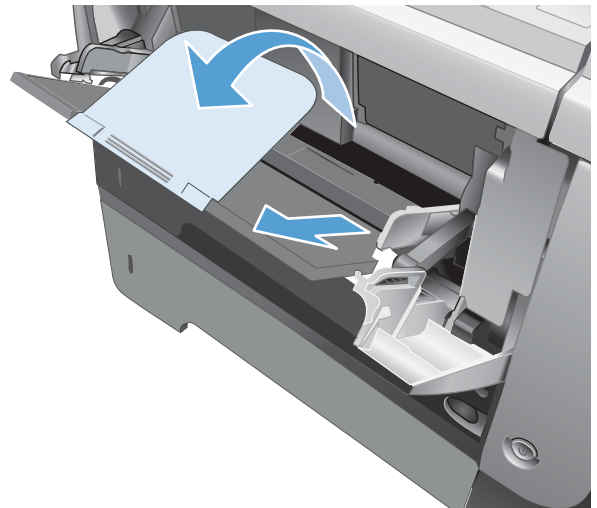



3. Load the paper into the tray. Make sure that the paper fits under the tabs and below the maximum-height indicators.

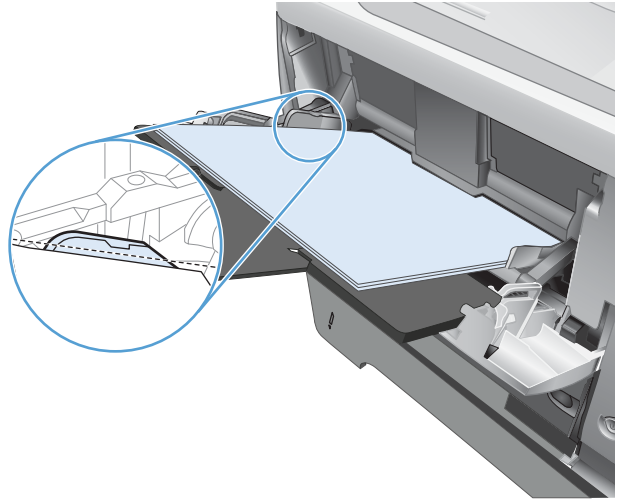

4. Adjust the side guides so that they lightly touch the paper stack but do not bend the paper.

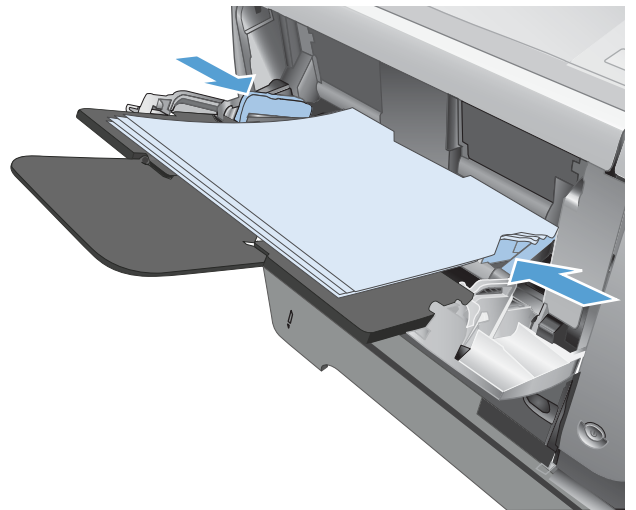

# Tray 2 and optional Tray 3

- [Tray capacity and paper orientation](#)
- [Load Tray 2 and optional Tray 3](#)

## Tray capacity and paper orientation

To prevent jams, do not overfill trays. Be sure the top of the stack is below the tray-full indicator. For short/narrow and heavy/glossy paper, load paper to less than half of the tray-full indicators.

**Table 2-5 Tray 2 and optional Tray 3 capacity**

Paper type	Specifications	Quantity
Paper	Range: 60 g/m <sup>2</sup> (16 lb) to 130 g/m <sup>2</sup> (35 lb)	Equivalent to 500 sheets of 75 g/m <sup>2</sup> (20 lb)

**Table 2-6 Tray 2 and optional Tray 3 paper orientation**

Single-sided printing	Automatic duplex printing and Alternative Letterhead Mode	Envelopes
Face-down Top edge at the front of the tray	Face-up Bottom edge at the front of the tray	Print envelopes only from Tray 1.

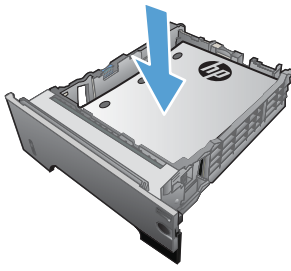
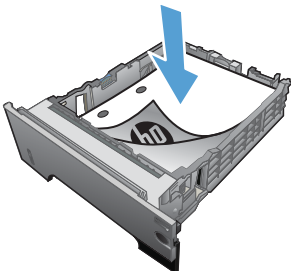

## Load Tray 2 and optional Tray 3

 **NOTE:** The procedure to load paper for Tray 3 is the same as for Tray 2. Only Tray 2 is shown here.

1. Pull the tray out and lift up slightly to remove it completely from the product.

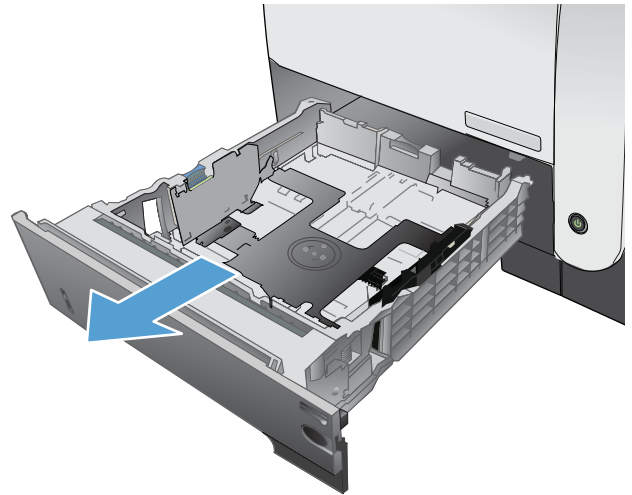

2. Pinch the release that is located on the left guide and slide the side guides to the correct paper size.

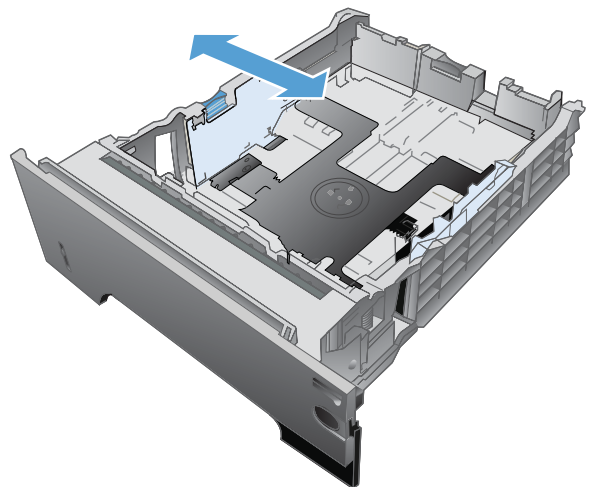

3. Pinch the release that is located on the rear paper guide and slide it to the correct paper size.

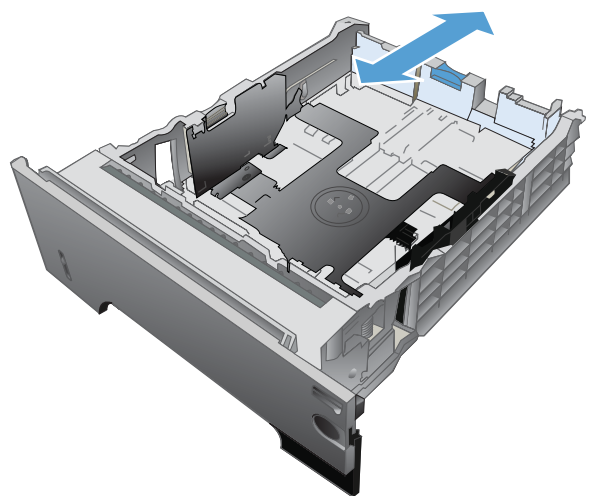

4. Load the paper into the tray. Make sure that the stack is flat at all four corners and that the top of the stack is below the maximum-height indicators.

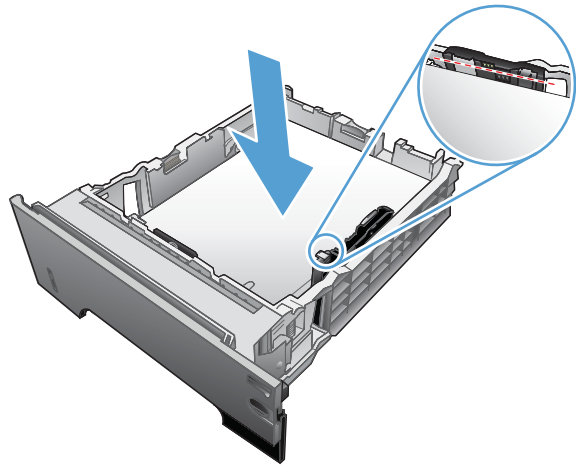

5. Slide the tray completely into the product.

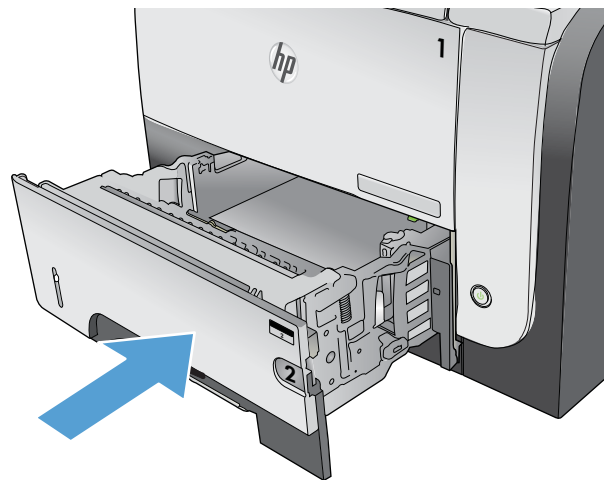

# Use paper output options

## Print to the standard output bin

The standard output bin collects paper face-down, in the correct order. Use this bin for most print jobs, including transparencies. To use the standard output bin, be sure that the rear output bin is closed. To avoid jams, do not open or close the rear output bin while the product is printing.

The standard output bin holds up to 250 sheets of 75 g/m<sup>2</sup> (20 lb) paper.

## Print to the rear output bin

The product always prints to the rear output bin if it is open. Paper that is printed to this bin will exit face-up, with the last page on top (reverse order).

The rear output bin holds up to 50 sheets of 75 g/m<sup>2</sup> (20 lb) paper.

Printing from Tray 1 to the rear output bin provides the straightest path. Opening the rear output bin might improve performance with the following items:

- Envelopes
- Labels
- Small custom-size paper
- Postcards
- Paper heavier than 120 g/m<sup>2</sup> (32 lb)

To open the rear output bin, grasp the handle at the top of the bin. Pull the bin down to a 45° angle, and slide out the extension.



 **NOTE:** Opening the rear output bin makes the duplexer and the top output bin unavailable. To avoid jams, do not open or close the rear output bin while the product is printing.



---

## 3 Parts, supplies, and accessories

- [Order parts, accessories, and supplies](#)
- [HP policy on non-HP supplies](#)
- [HP anticounterfeit Web site](#)
- [Print when a toner cartridge is at estimated end of life](#)
- [Customer self-repair parts](#)
- [Accessories](#)
- [Toner cartridge](#)

## Order parts, accessories, and supplies

HP original toner cartridges and paper	<a href="http://www.hp.com/go/suresupply">www.hp.com/go/suresupply</a>
Order genuine HP parts or accessories	<a href="http://www.hp.com/buy/parts">www.hp.com/buy/parts</a>
Order through service or support providers	Contact an HP-authorized service or support provider.



## HP policy on non-HP supplies

Hewlett-Packard Company cannot recommend the use of non-HP toner cartridges, either new or remanufactured.

---

 **NOTE:** For HP printer products, the use of a non-HP toner cartridge or a refilled toner cartridge does not affect either the warranty to the customer or any HP support contract with the customer. However, if product failure or damage is attributable to the use of a non-HP toner cartridge or refilled toner cartridge, HP will charge its standard time and materials charges to service the product for the particular failure or damage.

---

## HP anticounterfeit Web site

Go to [www.hp.com/go/anticounterfeit](http://www.hp.com/go/anticounterfeit) when you install an HP toner cartridge and the control-panel message says the cartridge is non-HP. HP will help determine if the cartridge is genuine and take steps to resolve the problem.

Your toner cartridge might not be a genuine HP toner cartridge if you notice the following:

- The supplies status page indicates that a non-HP supply is installed.
- You are experiencing a high number of problems with the toner cartridge.
- The cartridge does not look like it usually does (for example, the packaging differs from HP packaging).

# Print when a toner cartridge is at estimated end of life

**Black cartridge is low:** The product indicates when a toner cartridge level is low. Actual toner cartridge life remaining may vary. Consider having a replacement available to install when print quality is no longer acceptable. The toner cartridge does not need to be replaced now.

**Black cartridge is very low:** The product indicates when the toner cartridge level is very low. Actual toner cartridge life remaining may vary. Consider having a replacement available to install when print quality is no longer acceptable. The toner cartridge does not need to be replaced now unless the print quality is no longer acceptable.

Once an HP toner cartridge has reached “very low”, HP’s Premium Protection Warranty on that toner cartridge has ended.

You can change the way the product reacts when supplies reach the Very Low state. You do not have to re-establish these settings when you install a new toner cartridge.

## Enable or disable the Very Low Setting

You can enable or disable the default settings at any time, and you do not have to re-enable them when you install a new toner cartridge.

1. From the Home screen on the product control panel, touch the Setup  button.
2. Open the following menus:
  - [System Setup](#)
  - [Supply Settings](#)
  - [Black Cartridge](#)
  - [Very Low Setting](#)
3. Select one of the following options:
  - Select the [Continue](#) option to set the product to alert you that the toner cartridge is very low, but to continue printing.
  - Select the [Stop](#) option to set the product to stop printing (including printing faxes) until you replace the toner cartridge.
  - Select the [Prompt](#) option to set the product to stop printing (including printing faxes) and prompt you to replace the toner cartridge. You can acknowledge the prompt and continue printing. A customer configurable option on this product is "Prompt to Remind Me in 100 pages, 200 pages, 300 pages, 400 pages, or never." This option is provided as a customer convenience and is not an indication these pages will have acceptable print quality.

When the product is set to the [Stop](#) option, there is some risk that faxes will not print after the new cartridge is installed if your product has received more faxes than the memory can hold while stopped.

When the product is set to the **Prompt** option, there is some risk that faxes will not print after the new cartridge is installed if your product has received more faxes than the memory can hold while the product is waiting for the prompt to be acknowledged.

Once an HP toner cartridge has reached **Very Low**, HP's Premium Protection Warranty on that toner cartridge has ended. All print defects or cartridge failures incurred when an HP toner cartridge is used in **Continue** at very low mode will not be considered to be defects in materials or workmanship in the toner cartridge under the HP Toner Cartridge Warranty Statement.

# Customer self-repair parts

The following customer self-repair parts are available for the product.

- Parts listed as **Mandatory** self-replacement are to be installed by customers, unless you are willing to pay HP service personnel to perform the repair. For these parts, on-site or return-to-depot support is not provided under the HP product warranty.
- Parts listed as **Optional** self-replacement can be installed by HP service personnel at your request for no additional charge during the product warranty period.

 **NOTE:** For more information, go to [www.hp.com/go/learnaboutsupplies](http://www.hp.com/go/learnaboutsupplies).

**Table 3-1 Customer self-repair parts**

Item	Description	Self-replacement options	Part number
Toner cartridge, standard capacity	Replacement toner cartridge	Mandatory	CE255-67901
Toner cartridge, high capacity	Replacement toner cartridge	Mandatory	CE255-67902
Tray 2 cassette assembly	Replacement Tray 2	Mandatory	RM1-8512-000CN
Complete 500 Sheet Feeder (Optional Tray 3)	Optional 500-sheet feeder and installation instructions	Mandatory	CE530-69001
Document feeder roller maintenance kit	Replacement roller for the document feeder	Optional	A8P79-65001
Document feeder separation pad maintenance kit	Replacement separation pad for the document feeder	Optional	A8P79-65010
Power cable 220V-10A	Replacement cable – China	Mandatory	8121-0943
Power cable 110V-13A	Replacement cable – Taiwan	Mandatory	8121-0964
Power cable 220V-10A	Replacement cable – Korea, EU Generic	Mandatory	8121-0731
Power cable 220V-6A	Replacement cable – India	Mandatory	8121-0564
Power cable 220V – 10A	Replacement cable – UK/Asia Pacific	Mandatory	8121-0739
Power cable 220V – 10A	Replacement cable – Australia/New Zealand	Mandatory	8121-0837
Power cable 220V – 10A	Replacement cable – Israel	Mandatory	8121-1004
Power cable 220V – 10A	Replacement cable – Denmark	Mandatory	8121-0733
Power cable 220V – 10A	Replacement cable – South Africa	Mandatory	8121-0737
Power cable 220V – 10A	Replacement cable – Switzerland	Mandatory	8121-0738
Power cable 110V – 10A	Replacement cable – Brazil	Mandatory	8121-1071
Power cable 220V – 10A	Replacement cable – Argentina	Mandatory	8121-0729

**Table 3-1 Customer self-repair parts (continued)**

<b>Item</b>	<b>Description</b>	<b>Self-replacement options</b>	<b>Part number</b>
Power cable 220V – 10A	Replacement cable – South America/Chile/Peru	Mandatory	8121-0735
Power cable 220 / 110V	Replacement cable – Thailand/Philippines	Mandatory	8121-0734
Power cable 110V – 10A	Replacement cable – Saudi Arabia/Others	Mandatory	8121-0740

## Accessories

<b>Item</b>	<b>Description</b>	<b>Part number</b>
Optional 500-sheet tray and feeder unit	Optional tray to increase paper capacity.	CE530A
MFP Stand	A storage cabinet that is installed beneath the product.	CF338A
USB cable	2-meter standard USB-compatible device connector	C6518A

# Toner cartridge

- [Toner-cartridge view](#)
- [Toner-cartridge information](#)
- [Replace the toner cartridge](#)

## Toner-cartridge view

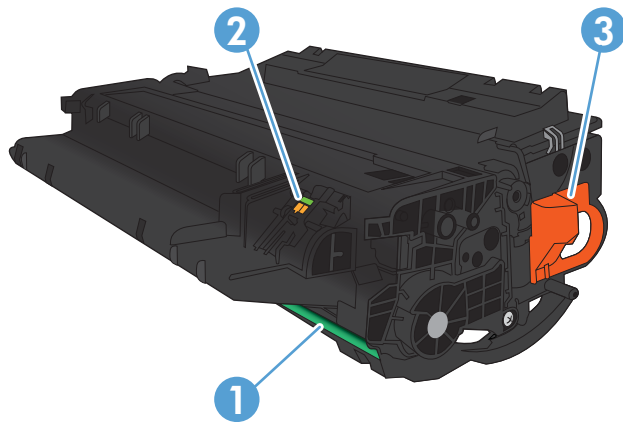

1	Imaging drum <b>CAUTION:</b> Do not touch the shutter or the surface of the roller. Doing so can damage the cartridge.
2	Memory chip
3	Pull tab for the sealing tape



## Toner-cartridge information

Capacity	Cartridge number	Part number
Standard-capacity replacement black toner cartridge	55A	CE255A
High-capacity replacement black toner cartridge	55X	CE255X

For more information about supplies, go to [www.hp.com/go/learnaboutsupplies](http://www.hp.com/go/learnaboutsupplies).

The information contained herein is subject to change without notice. For the latest supplies information go to [www.hp.com/support/ljmfpm521series](http://www.hp.com/support/ljmfpm521series).

## Recycle the toner cartridge

To recycle a genuine HP toner cartridge, place the used cartridge in the box in which the new cartridge arrived. Use the enclosed return label to send the used supply to HP for recycling. For complete information, see the recycling guide that is included with each new HP supply item.

## Toner-cartridge storage

Do not remove the toner cartridge from its package until you are ready to use it.

 **CAUTION:** To prevent damage to the toner cartridge, do not expose it to light for more than a few minutes.

## HP policy on non-HP toner cartridges

Hewlett-Packard Company cannot recommend the use of non-HP toner cartridges, either new or remanufactured.

 **NOTE:** Any damage caused by a non-HP toner cartridge is not covered under the HP warranty and service agreements.

## Replace the toner cartridge

**CAUTION:** If toner gets on clothing, wipe it off by using a dry cloth and wash the clothes in cold water. Hot water sets toner into fabric.

**NOTE:** Information about recycling used toner cartridges is on the toner-cartridge box.

1. Press the front-door-release button.



2. Open the front door.



3. Remove the used toner cartridge from the product.

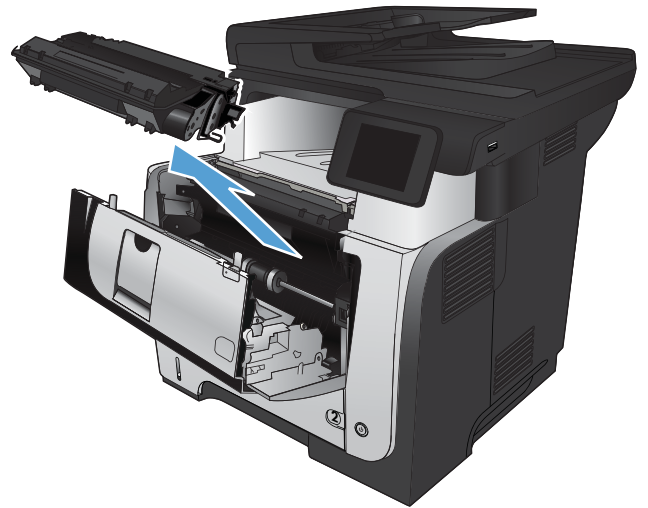

4. Remove the new toner cartridge from the bag. Place the used toner cartridge in the bag for recycling.

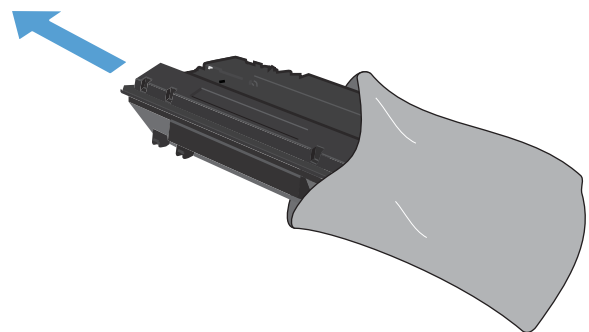

5. Grasp the front and back of the toner cartridge, and distribute the toner by gently rocking the toner cartridge five or six times.

**CAUTION:** Do not touch the shutter or the surface of the roller.

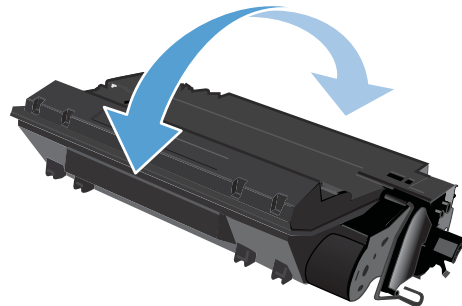

6. Remove the sealing tape from the new toner cartridge. Recycle the tape with the used toner cartridge.

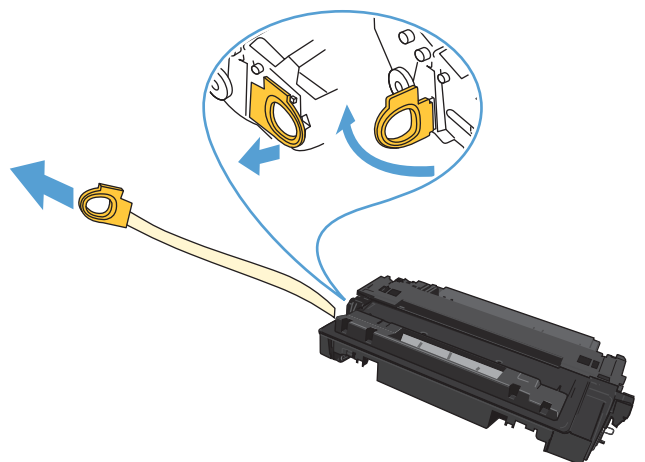

7. Align the toner cartridge with the tracks inside the product, and insert the toner cartridge until it is firmly seated.



8. Close the front door.

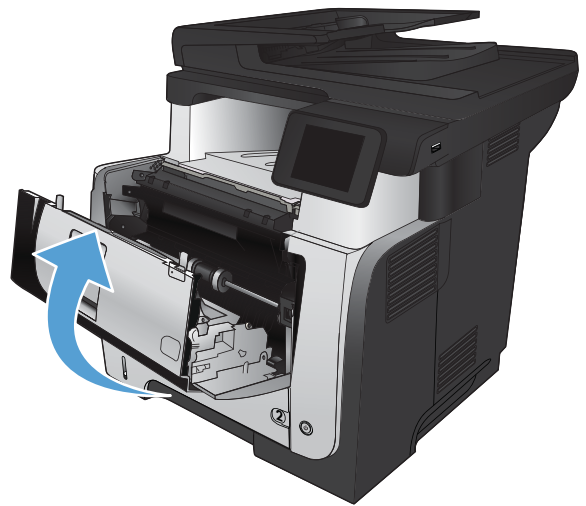

---

# 4 Print

- [Supported print drivers \(Windows\)](#)
- [Change print-job settings \(Windows\)](#)
- [Change print-job settings \(Mac OS X\)](#)
- [Print tasks \(Windows\)](#)
- [Print tasks \(Mac OS X\)](#)
- [Create archival-quality prints](#)
- [Use HP ePrint](#)
- [Use AirPrint](#)
- [Use walk-up USB printing](#)

# Supported print drivers (Windows)

Print drivers provide access to the product printing system. The following print drivers are available at [www.hp.com/go/ljmfpm521series\\_software](http://www.hp.com/go/ljmfpm521series_software).

---

## HP PCL 6 driver

- Provided as the default driver on the in-box CD. This driver is automatically installed unless you select a different one.
- Recommended for all Windows environments
- Provides the overall best speed, print quality, and product-feature support for most users
- Developed to align with the Windows Graphic Device Interface (GDI) for the best speed in Windows environments
- Might not be fully compatible with third-party and custom software programs that are based on PCL 5

---

## HP UPD PS driver

- Recommended for printing with Adobe® software programs or with other highly graphics-intensive software programs
- Provides support for printing from postscript emulation needs, or for postscript flash font support

---

## HP UPD PCL 5

- Recommended for general office printing in Windows environments
- Compatible with previous PCL versions and older HP LaserJet products
- The best choice for printing from third-party or custom software programs
- The best choice when operating with mixed environments, which require the product to be set to PCL 5 (UNIX, Linux, mainframe)
- Designed for use in corporate Windows environments to provide a single driver for use with multiple product models
- Preferred when printing to multiple product models from a mobile Windows computer

---

## HP UPD PCL 6

- Recommended for printing in all Windows environments
  - Provides the overall best speed, print quality, and printer feature support for most users
  - Developed to align with Windows Graphic Device Interface (GDI) for best speed in Windows environments
  - Might not be fully compatible with third-party and custom software programs that are based on PCL 5
- 

## HP Universal Print Driver (UPD)

The HP Universal Print Driver (UPD) for Windows is a single print driver that gives you instant access to virtually any HP LaserJet product, from any location, without downloading separate drivers. It is built on proven HP print driver technology and has been tested thoroughly and used with many software programs. It is a powerful solution that performs consistently over time.

The HP UPD communicates directly with each HP product, gathers configuration information, and then customizes the user interface to show the product's unique, available features. It automatically enables features that are available for the product, such as two-sided printing and stapling, so you do not need to enable them manually.

For more information, go to [www.hp.com/go/upd](http://www.hp.com/go/upd).

## UPD installation modes

---

Traditional mode	<ul style="list-style-type: none"><li>• To use this mode, download UPD from the Internet. Go to <a href="http://www.hp.com/go/upd">www.hp.com/go/upd</a>.</li><li>• Use this mode if you are installing the driver for a single computer.</li><li>• It operates with a specific product.</li><li>• If you use this mode, you must install UPD separately for each computer and for each product.</li></ul>
Dynamic mode	<ul style="list-style-type: none"><li>• To use this mode, download UPD from the Internet. Go to <a href="http://www.hp.com/go/upd">www.hp.com/go/upd</a>.</li><li>• Dynamic mode allows you to use a single driver installation, so you can discover and print to multiple networked HP products in any location.</li><li>• Use this mode if you are installing UPD for a workgroup.</li><li>• Do not use this mode for USB-connected products.</li></ul>

---

# Change print-job settings (Windows)

- [Priority for changing print-job settings](#)
- [Change the settings for all print jobs until the software program is closed](#)
- [Change the default settings for all print jobs](#)
- [Change the product configuration settings](#)

## Priority for changing print-job settings

Changes to print settings are prioritized depending on where the changes are made:



**NOTE:** The names of commands and dialog boxes might vary depending on your software program.

- **Page Setup dialog box:** Click **Page Setup** or a similar command on the **File** menu of the program you are working in to open this dialog box. Settings changed here override settings changed anywhere else.
- **Print dialog box:** Click **Print**, **Print Setup**, or a similar command on the **File** menu of the program you are working in to open this dialog box. Settings changed in the **Print** dialog box have a lower priority and usually do not override changes made in the **Page Setup** dialog box.
- **Printer Properties dialog box (print driver):** Click **Properties** in the **Print** dialog box to open the print driver. Settings changed in the **Printer Properties** dialog box usually do not override settings anywhere else in the printing software. You can change most of the print settings here.
- **Default print driver settings:** The default print driver settings determine the settings used in all print jobs, *unless* settings are changed in the **Page Setup**, **Print**, or **Printer Properties** dialog boxes.
- **Product control-panel settings:** Settings changed at the product control panel have a lower priority than changes made anywhere else.

## Change the settings for all print jobs until the software program is closed

The steps can vary; this procedure is most common.

1. From the software program, select the **Print** option.
2. Select the product, and then click **Properties** or **Preferences**.



## Change the default settings for all print jobs

1. **Windows XP, Windows Server 2003, and Windows Server 2008 (using the default Start menu view):** Click **Start**, and then click **Printers and Faxes**.

**Windows XP, Windows Server 2003, and Windows Server 2008 (using the Classic Start menu view):** Click **Start**, click **Settings**, and then click **Printers**.

**Windows Vista:** Click the Windows icon in the lower-left corner of the screen, click **Control Panel**, and then click **Printers**.

**Windows 7:** Click the Windows icon in the lower-left corner of the screen, and then click **Devices and Printers**.

2. Right-click the print-driver icon for this product, and then select **Printing Preferences**.

## Change the product configuration settings

1. **Windows XP, Windows Server 2003, and Windows Server 2008 (using the default Start menu view):** Click **Start**, and then click **Printers and Faxes**.

**Windows XP, Windows Server 2003, and Windows Server 2008 (using the Classic Start menu view):** Click **Start**, click **Settings**, and then click **Printers**.

**Windows Vista:** Click the Windows icon in the lower-left corner of the screen, click **Control Panel**, and then click **Printers**.

**Windows 7:** Click the Windows icon in the lower-left corner of the screen, and then click **Devices and Printers**.

2. Right-click the print-driver icon for this product, and then select **Properties** or **Printer properties**.
3. Click the **Device Settings** tab.

# Change print-job settings (Mac OS X)

- [Priority for changing print-job settings](#)
- [Change the settings for all print jobs until the software program is closed](#)
- [Change the default settings for all print jobs](#)
- [Change the product configuration settings](#)

## Priority for changing print-job settings

Changes to print settings are prioritized depending on where the changes are made:



**NOTE:** The names of commands and dialog boxes might vary depending on your software program.

- **Page Setup dialog box:** Click **Page Setup** or a similar command on the **File** menu of the program you are working in to open this dialog box. Settings changed here might override settings changed anywhere else.
- **Print dialog box:** Click **Print**, **Print Setup**, or a similar command on the **File** menu of the program you are working in to open this dialog box. Settings changed in the **Print** dialog box have a lower priority and do *not* override changes made in the **Page Setup** dialog box.
- **Default printer driver settings:** The default printer driver settings determine the settings used in all print jobs, *unless* settings are changed in the **Page Setup**, **Print**, or **Printer Properties** dialog boxes.
- **Product control-panel settings:** Settings changed at the product control panel have a lower priority than changes made anywhere else.

## Change the settings for all print jobs until the software program is closed

1. Click the **File** menu, and then click the **Print** option.
2. In the **Printer** menu, select the product.
3. By default, the print driver displays the **Copies & Pages** menu. Open the menu drop-down list, and then open a menu for which you want to change the print settings.
4. For each menu, select the print settings that you want to change.
5. Change the settings that you want on the various menus.

## Change the default settings for all print jobs

1. Click the **File** menu, and then click the **Print** option.
2. In the **Printer** menu, select the product.

3. By default, the print driver displays the **Copies & Pages** menu. Open the menus drop-down list, and then open a menu for which you want to change the print settings.
4. For each menu, select the print settings that you want to save for reuse.
5. In the **Presets** menu, click the **Save As...** option, and enter a name for the preset.
6. Click the **OK** button.

These settings are saved in the **Presets** menu. To use the new settings, you must select the saved preset option every time you open a program and print.

## Change the product configuration settings

1. At the computer, open the Apple  menu, click the **System Preferences** item, and then click the **Print & Fax** icon or the **Print & Scan** icon.
2. Select the product in the left side of the window.
3. Click the **Options & Supplies** button.
4. Click the **Driver** tab.
5. Configure the installed options.

## Print tasks (Windows)

- [Use a printing shortcut \(Windows\)](#)
- [Create printing shortcuts \(Windows\)](#)
- [Automatically print on both sides \(Windows\)](#)
- [Manually print on both sides \(Windows\)](#)
- [Print multiple pages per sheet \(Windows\)](#)
- [Select the page orientation \(Windows\)](#)
- [Select the paper type \(Windows\)](#)
- [Print the first or last page on different paper \(Windows\)](#)
- [Scale a document to fit page size \(Windows\)](#)
- [Create a booklet \(Windows\)](#)
- [Select the paper size \(Windows\)](#)
- [Select a custom paper size \(Windows\)](#)
- [Print watermarks \(Windows\)](#)
- [Cancel a print job \(Windows\)](#)

## Use a printing shortcut (Windows)

1. From the software program, select the **Print** option.
2. Select the product, and then click the **Properties** or **Preferences** button.

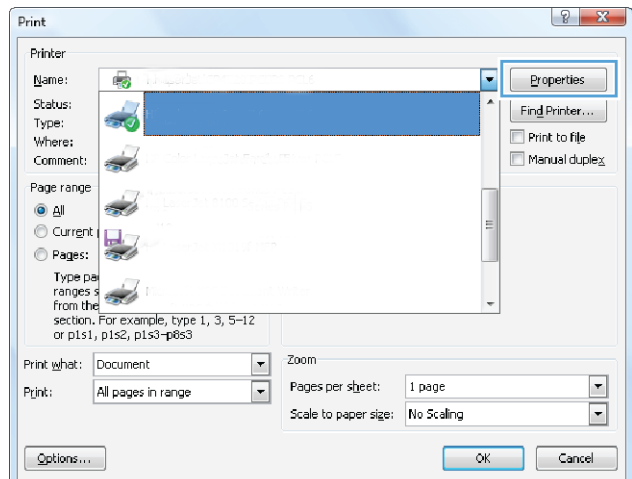

3. Click the **Printing Shortcuts** tab.

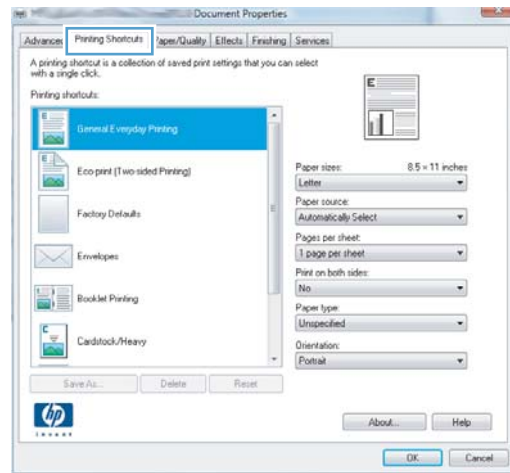

4. Select one of the shortcuts. Click the **OK** button to close the **Document Properties** dialog box.

**NOTE:** When you select a shortcut, the corresponding settings change on the other tabs in the print driver.



5. In the **Print** dialog box, click the **OK** button to print the job.

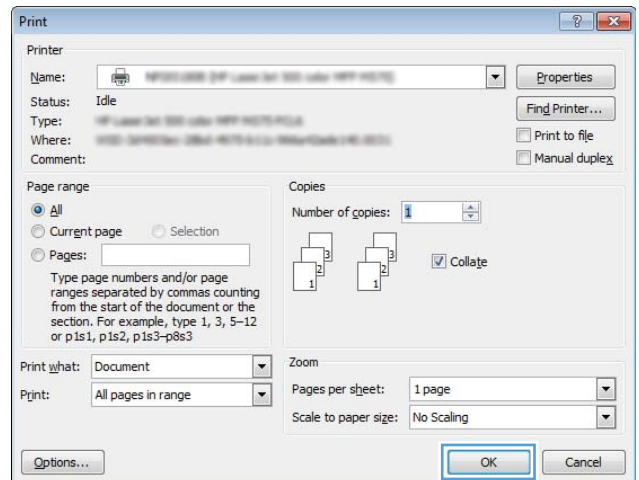

## Create printing shortcuts (Windows)

1. From the software program, select the **Print** option.
2. Select the product, and then click the **Properties** or **Preferences** button.

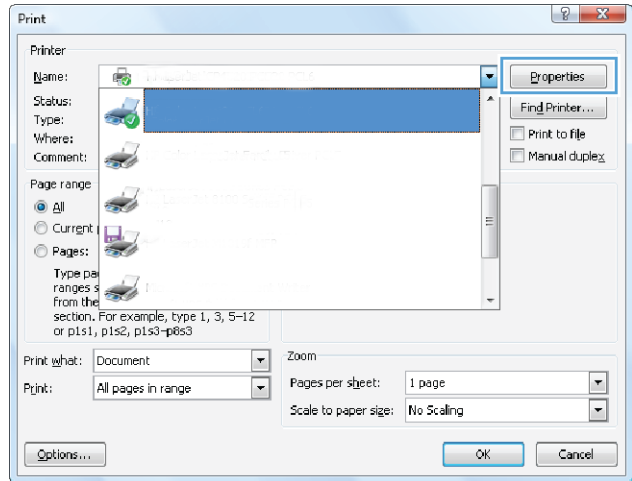

3. Click the **Printing Shortcuts** tab.

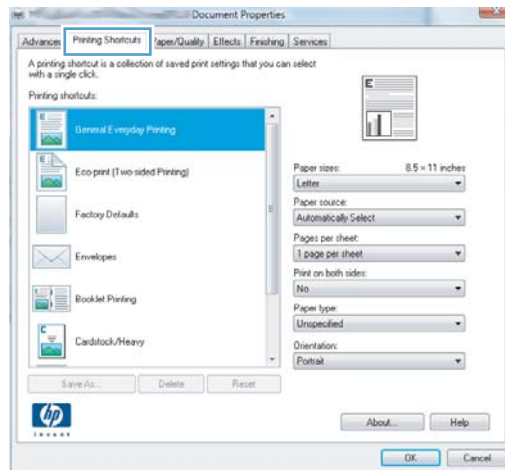

4. Select an existing shortcut as a base.

**NOTE:** Always select a shortcut before adjusting any of the settings on the right side of the screen. If you adjust the settings and then select a shortcut, all your adjustments are lost.

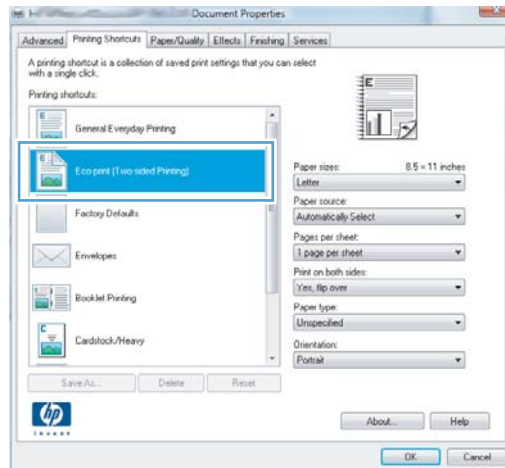

5. Select the print options for the new shortcut.

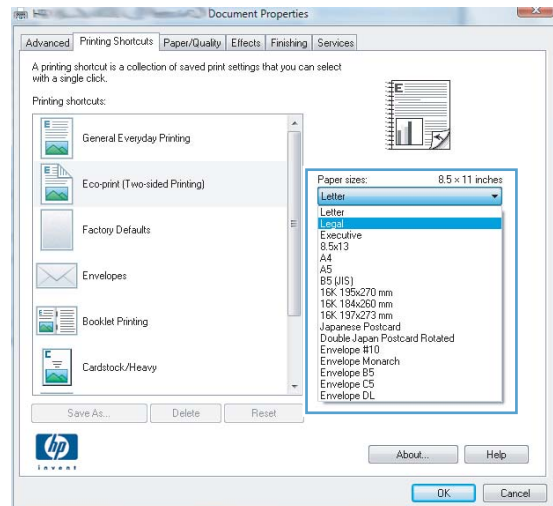

6. Click the **Save As** button.

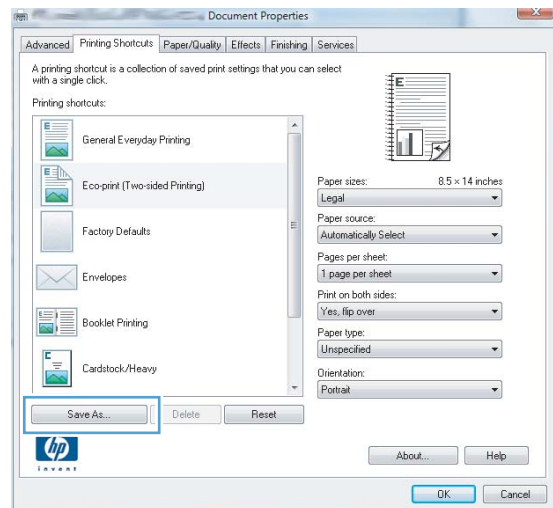

7. Enter a name for the shortcut, and then click the **OK** button.

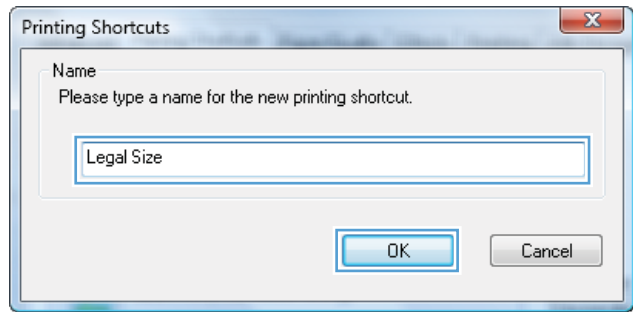

8. Click the **OK** button to close the **Document Properties** dialog box. In the **Print** dialog box, click the **OK** button to print the job.

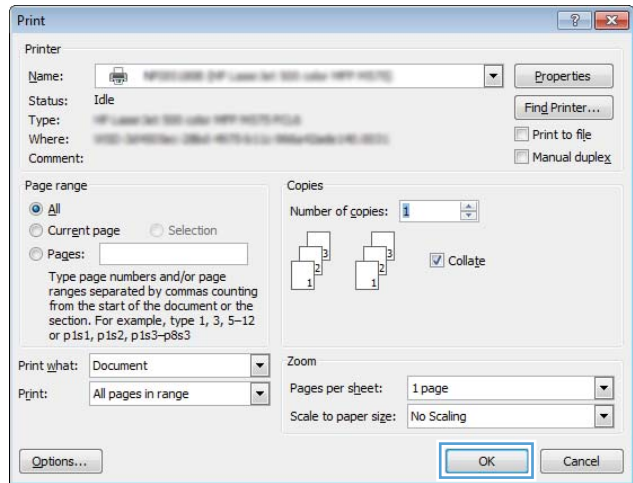



## Automatically print on both sides (Windows)

The product supports the following paper sizes for automatic duplex printing:

- Letter
- Legal
- A4
- 8.5 x 13

The product supports the following paper types for automatic duplex printing:

- Unspecified
- Plain
- HP EcoSMART Lite
- Light 60–74 g
- Midweight 96–110 g
- Letterhead
- Preprinted
- Prepunched
- Colored
- Bond
- Recycled

For other paper types or sizes, use manual duplex printing.

1. From the software program, select the **Print** option.
2. Select the product, and then click the **Properties** or **Preferences** button.

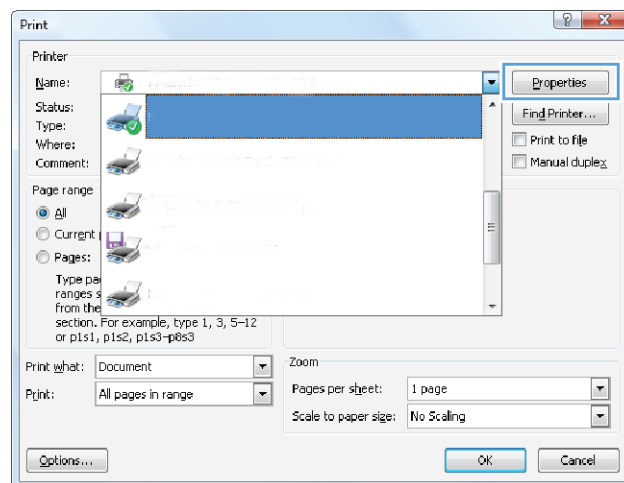

3. Click the **Finishing** tab.

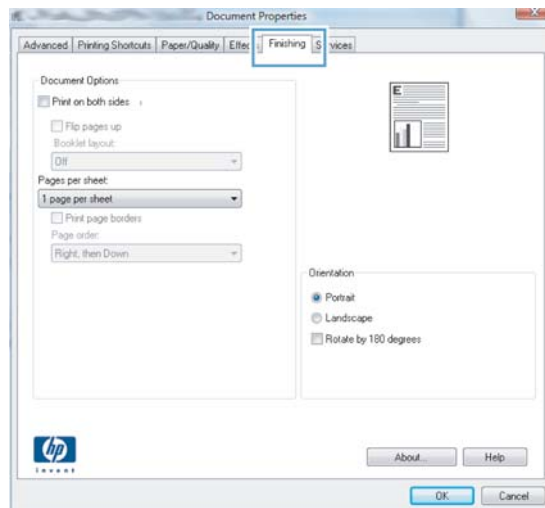

4. Select the **Print on both sides** check box. Click the **OK** button to close the **Document Properties** dialog box.

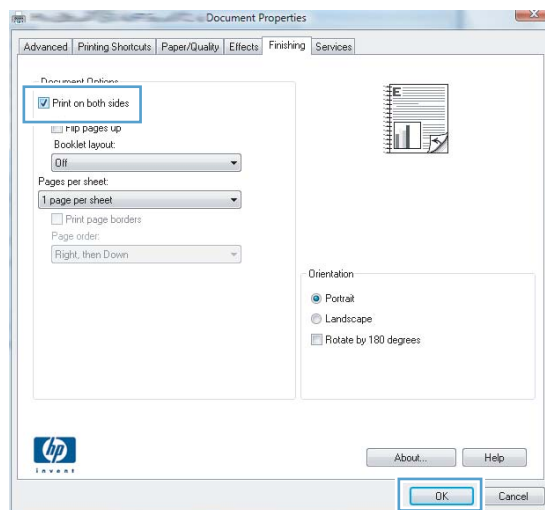

5. In the **Print** dialog box, click the **OK** button to print the job.

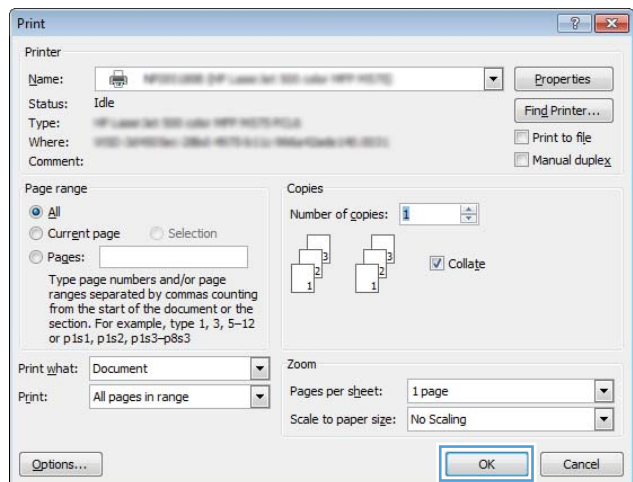

## Manually print on both sides (Windows)

For paper sizes and types that the automatic duplexer does not support, use manual duplex printing. To use this option, the product must be configured to enable manual duplexing. The first five steps of the following task need to be performed only one time. After that, you can manually print on both sides by starting with step 6.

1. **Windows XP, Windows Server 2003, and Windows Server 2008 (using the default Start menu view):** Click **Start**, and then click **Printers and Faxes**.

**Windows XP, Windows Server 2003, and Windows Server 2008 (using the Classic Start menu view):** Click **Start**, click **Settings**, and then click **Printers**.

**Windows Vista:** Click the Windows icon in the lower-left corner of the screen, click **Control Panel**, and then click **Printers**.

**Windows 7:** Click the Windows icon in the lower-left corner of the screen, and then click **Devices and Printers**.

2. Right-click the print-driver icon, and then select **Printer properties**.
3. Click the **Device Settings** tab.
4. Expand the list of **Installable options**, and in the drop-down list next to **Allow Manual Duplexing**: select **Enabled**.

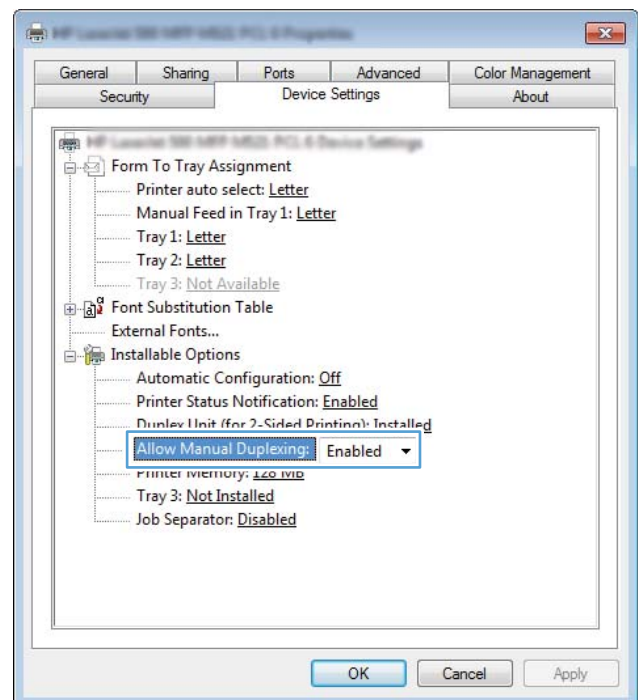

5. Click the **OK** button.

6. Load Tray 1 with the paper for your document.

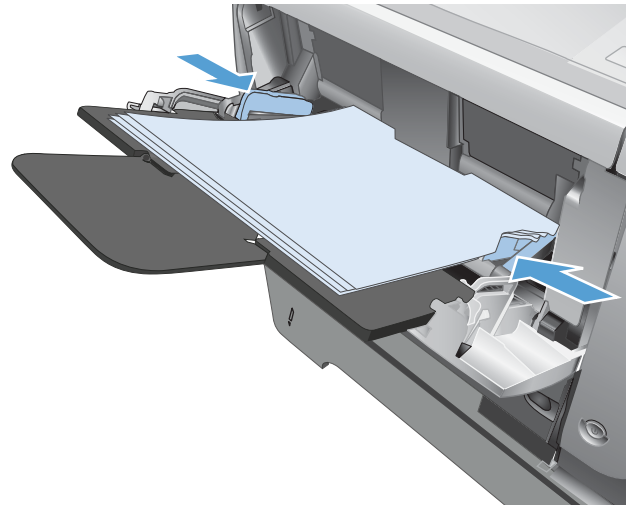

7. From the software program, select the **Print** option.

8. Select the product, and then click the **Properties** or **Preferences** button.

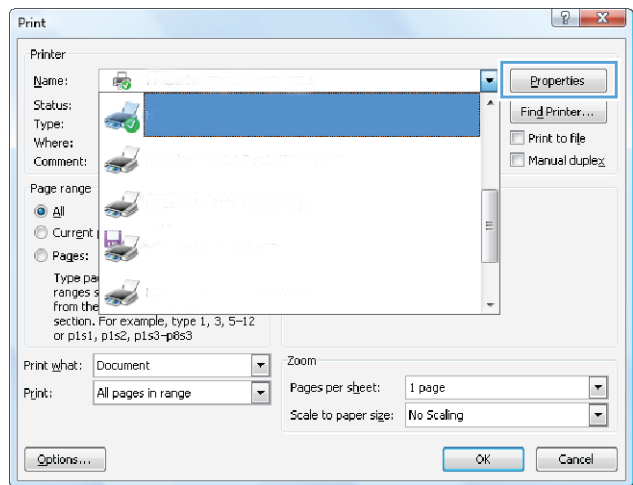

9. Click the **Paper/Quality** tab.

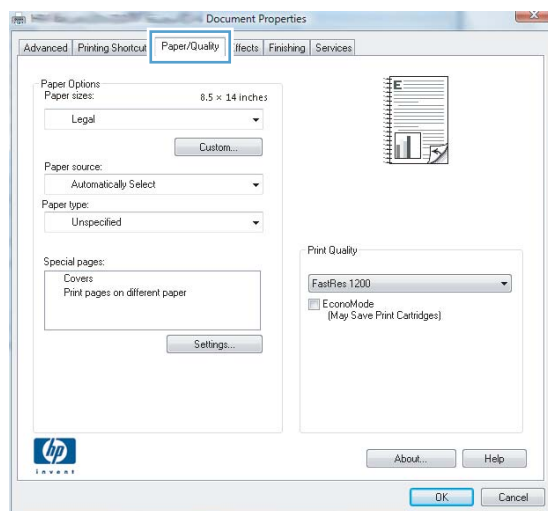

10. Select the appropriate paper size for your document, and select the type of paper you are using. In the **Paper source** drop-down list, select the **Manual Feed in Tray 1** option.

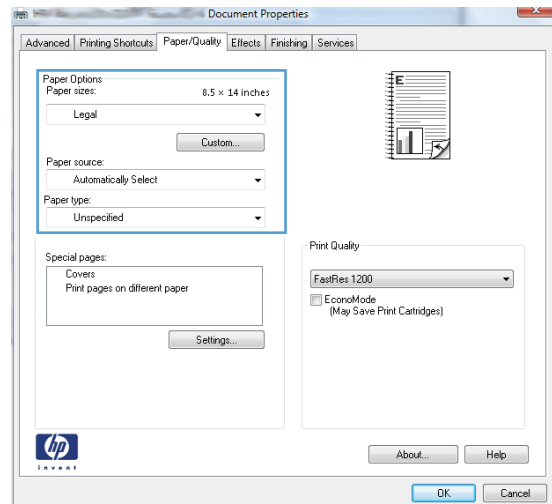

11. Click the **Finishing** tab.

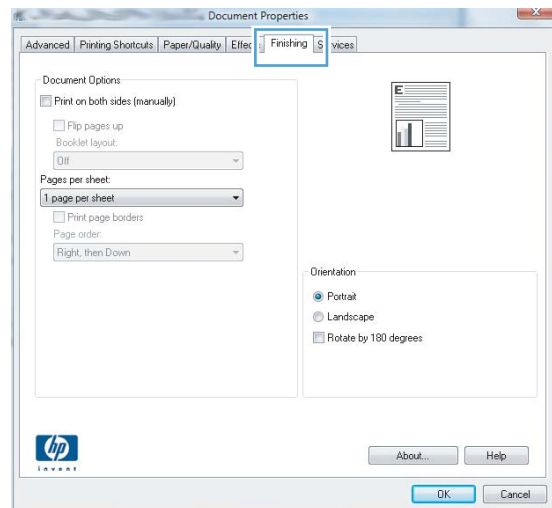

12. Select the **Print on both sides (manually)** check box. Click the **OK** button to print the first side of the job.

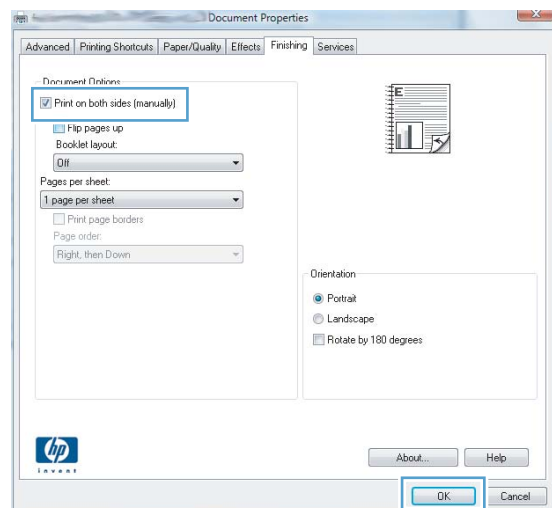

13. Retrieve the printed stack from the output bin, and place it with the printed-side facing down in Tray 1.

**NOTE:** Do not rotate or turn over the pages.

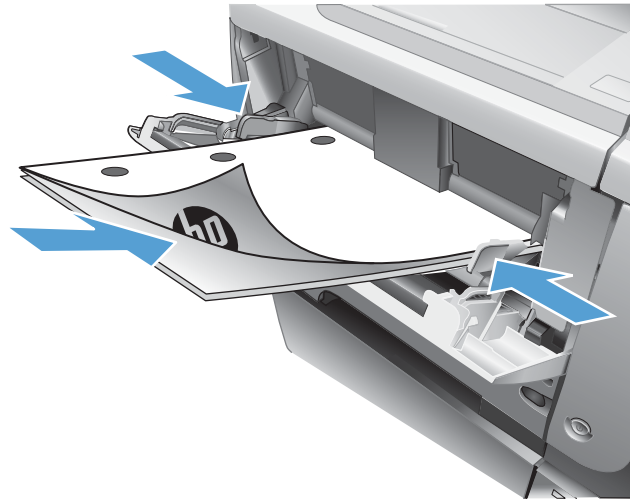

14. If prompted, touch the appropriate control panel button to continue.

## Print multiple pages per sheet (Windows)

1. From the software program, select the **Print** option.
2. Select the product, and then click the **Properties** or **Preferences** button.

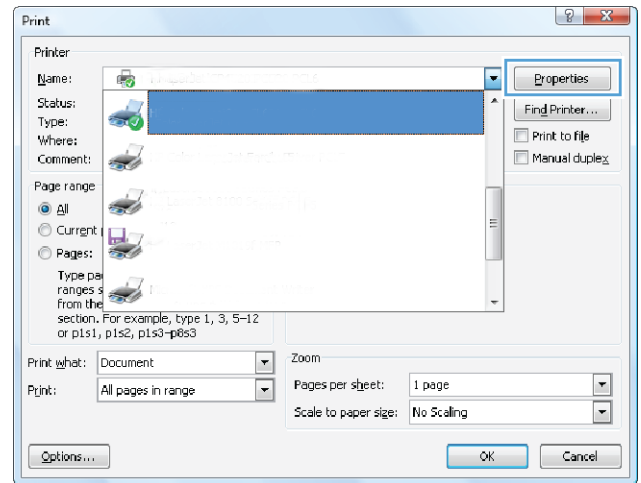

3. Click the **Finishing** tab.

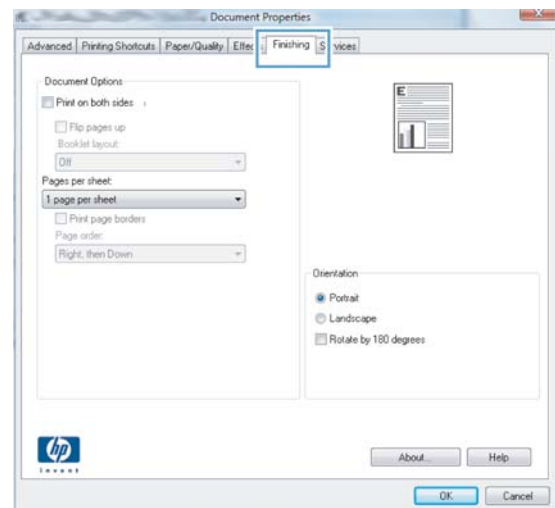

4. Select the number of pages per sheet from the **Pages per sheet** drop-down list.

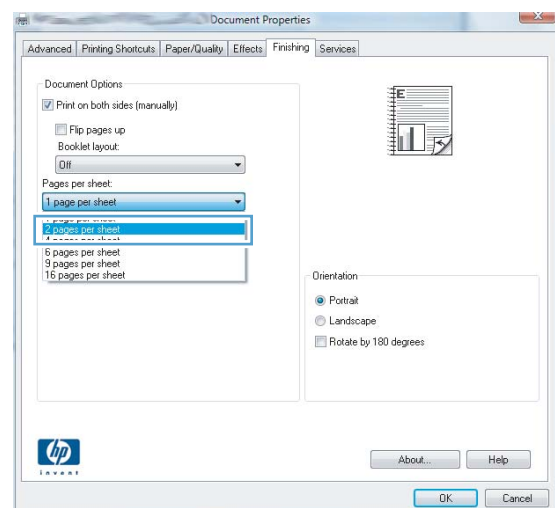

5. Select the correct **Print page borders**, **Page order**, and **Orientation** options. Click the **OK** button to close the **Document Properties** dialog box.

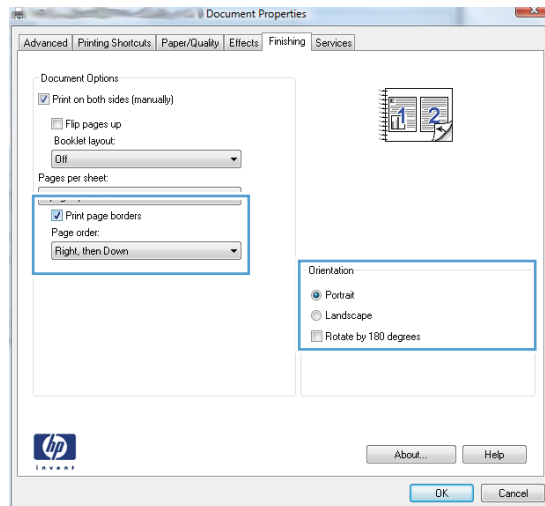

6. In the **Print** dialog box, click the **OK** button to print the job.

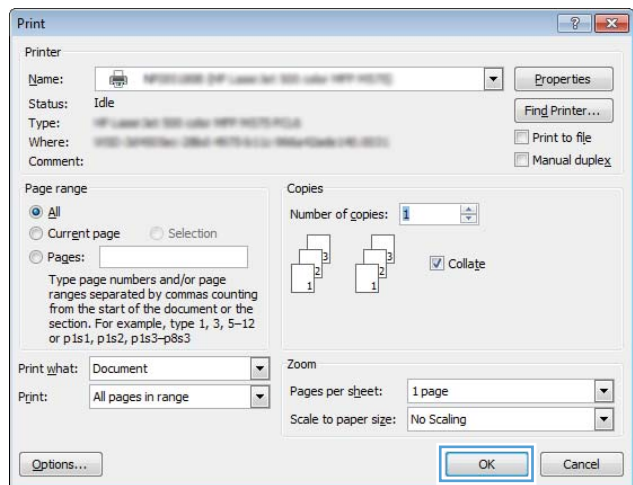



## Select the page orientation (Windows)

1. From the software program, select the **Print** option.
2. Select the product, and then click the **Properties** or **Preferences** button.

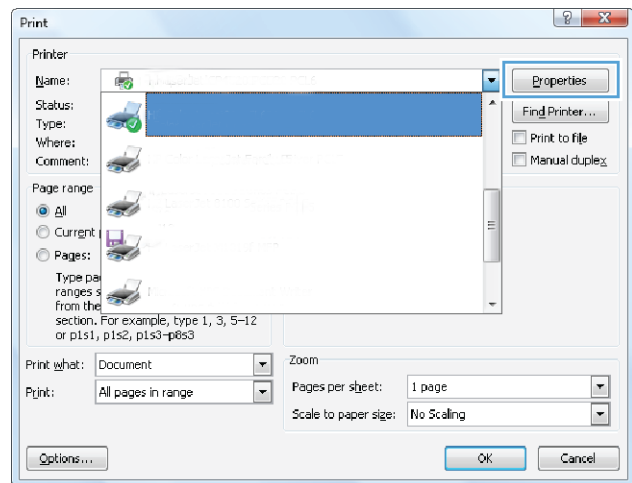

3. Click the **Finishing** tab.

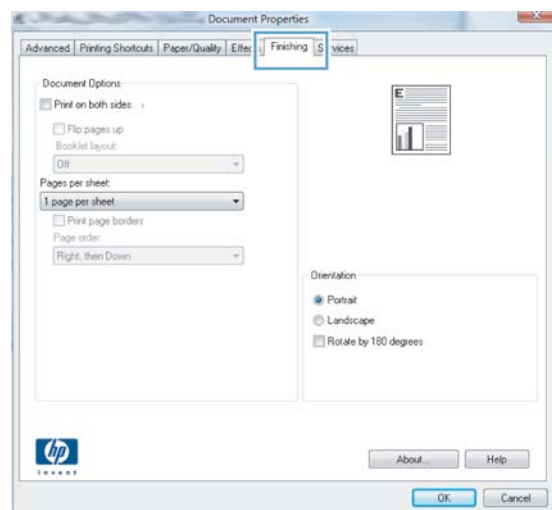

4. In the **Orientation** area, select the **Portrait** or **Landscape** option.

To print the page image upside down, select the **Rotate by 180 degrees** option.

Click the **OK** button to close the **Document Properties** dialog box.

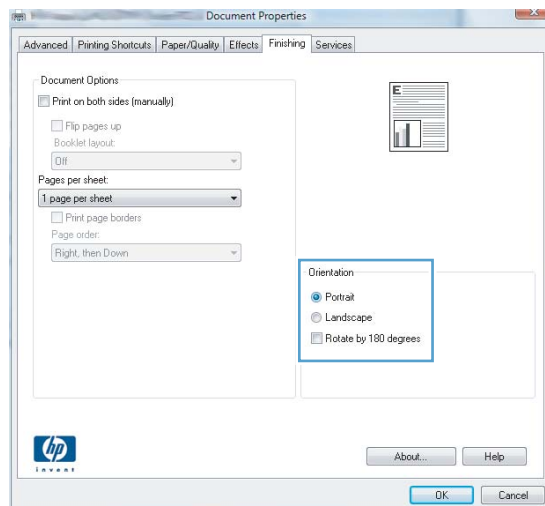

5. In the **Print** dialog box, click the **OK** button to print the job.

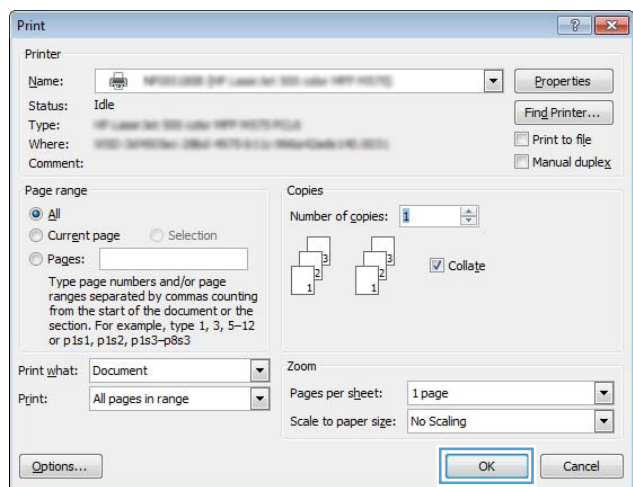

## Select the paper type (Windows)

1. From the software program, select the **Print** option.
2. Select the product, and then click the **Properties** or **Preferences** button.

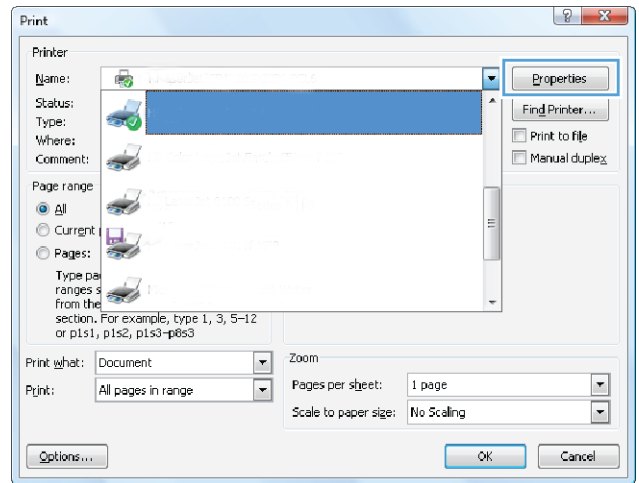

3. Click the **Paper/Quality** tab.

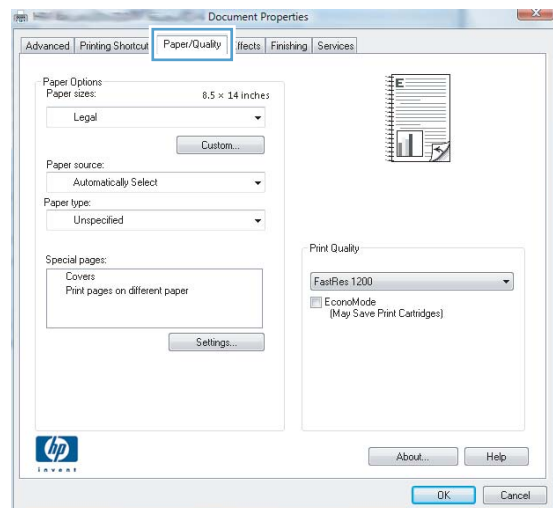

4. From the **Paper type** drop-down list, click the **More...** option.

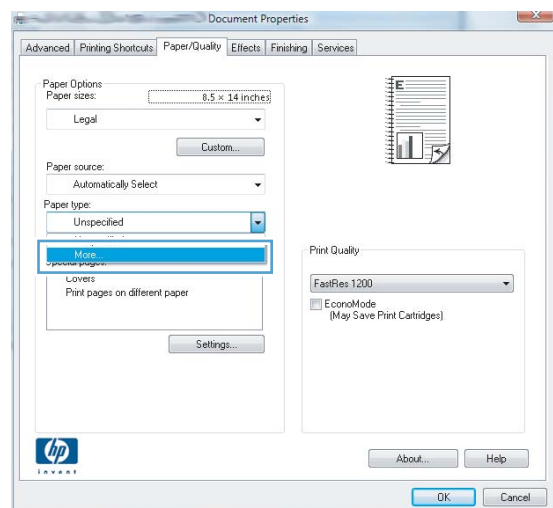

5. Expand the list of **Type is:** options.

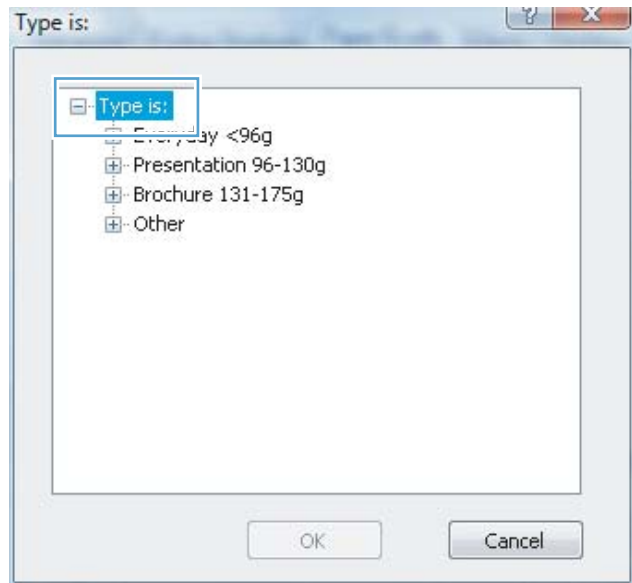

6. Expand the category of paper types that best describes your paper.

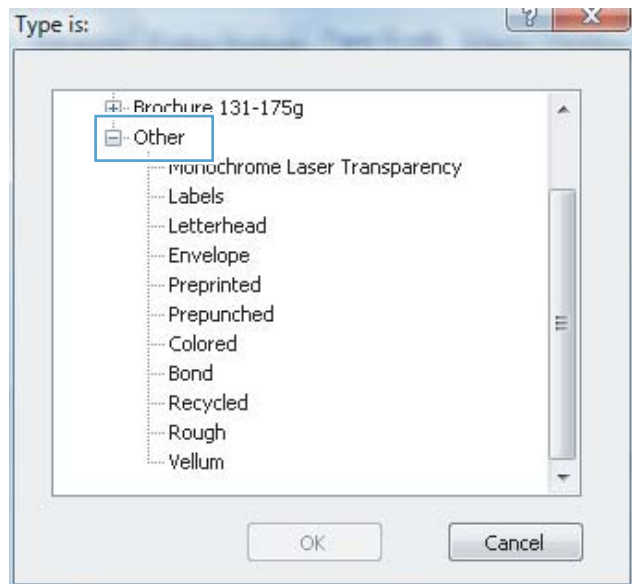

7. Select the option for the type of paper you are using, and click the **OK** button.

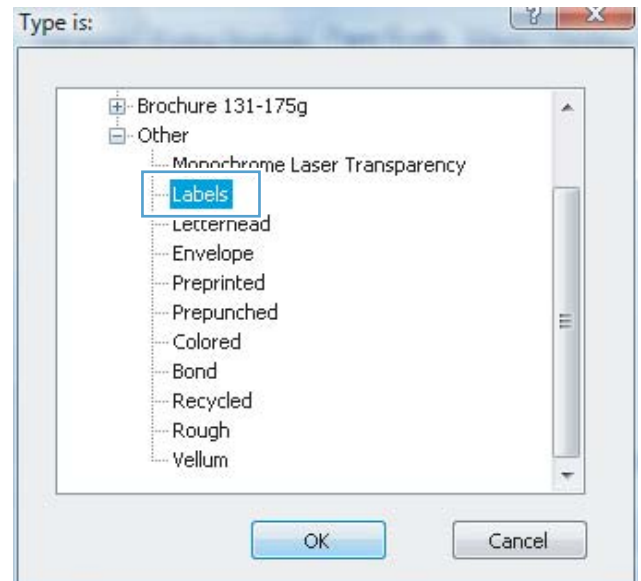

8. Click the **OK** button to close the **Document Properties** dialog box. In the **Print** dialog box, click the **OK** button to print the job.

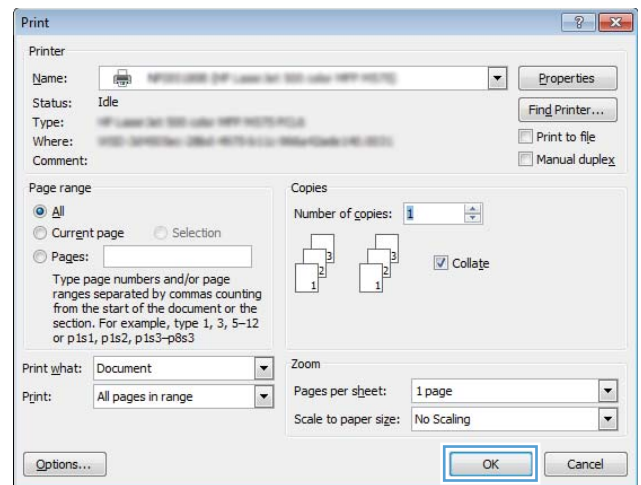

## Print the first or last page on different paper (Windows)

1. From the software program, select the **Print** option.
2. Select the product, and then click the **Properties** or **Preferences** button.

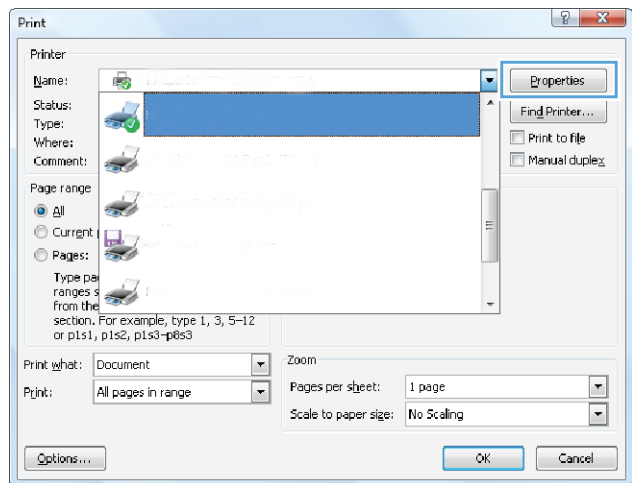

3. Click the **Paper/Quality** tab.

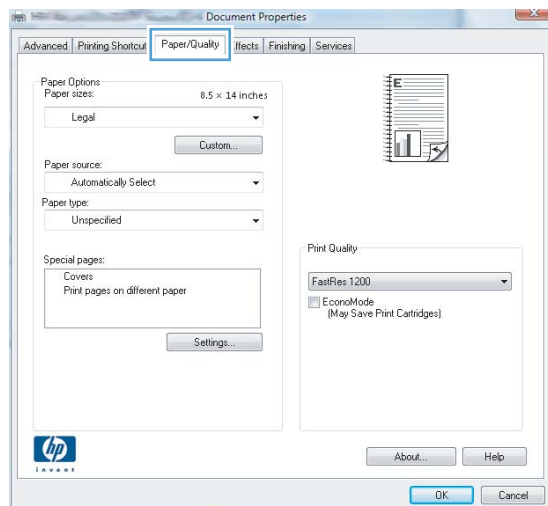

4. In the **Special pages** area, click the **Print pages on different paper** option, and then click the **Settings** button.

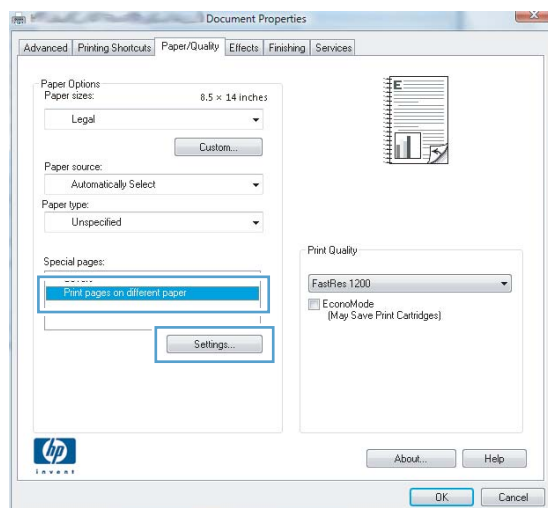

- In the **Pages in document** area, select either the **First** or **Last** option.

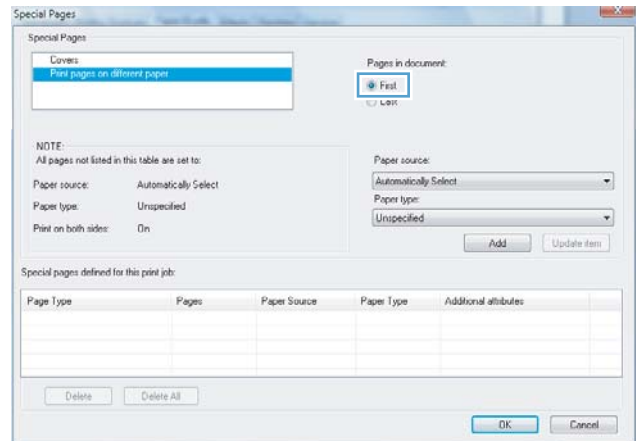

- Select the correct options from the **Paper source** and **Paper type** drop-down lists. Click the **Add** button.

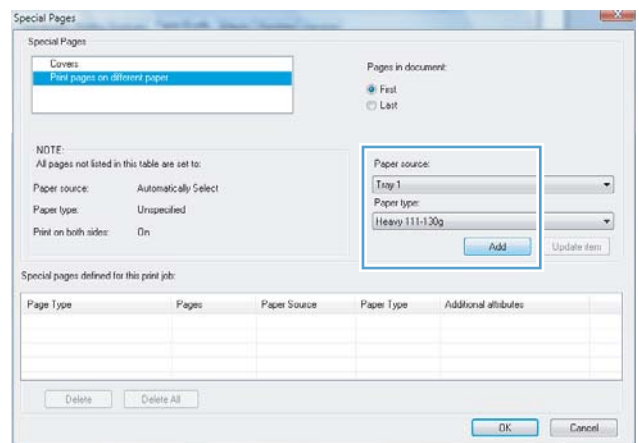

- If you are printing *both* the first and last pages on different paper, repeat steps 5 and 6, selecting the options for the other page.

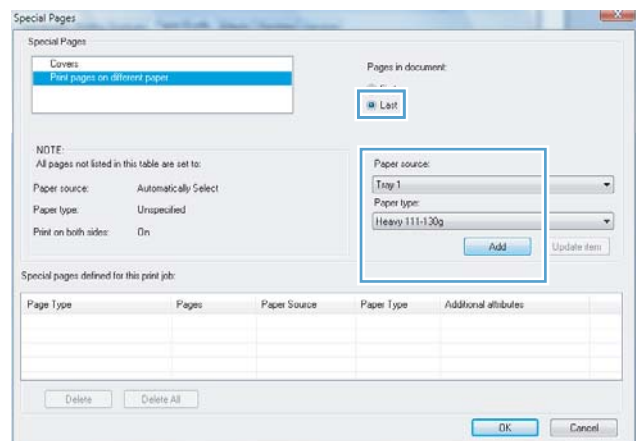

8. Click the **OK** button.

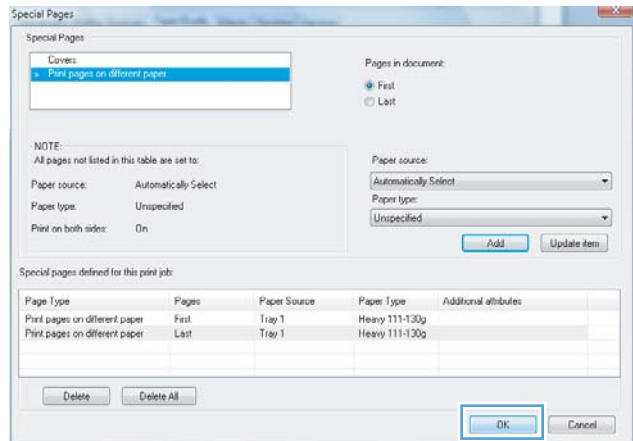

9. Click the **OK** button to close the **Document Properties** dialog box. In the **Print** dialog box, click the **OK** button to print the job.

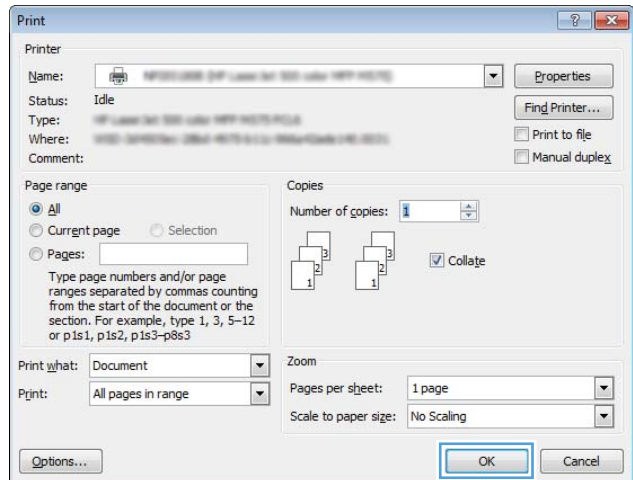



## Scale a document to fit page size (Windows)

1. From the software program, select the **Print** option.
2. Select the product, and then click the **Properties** or **Preferences** button.

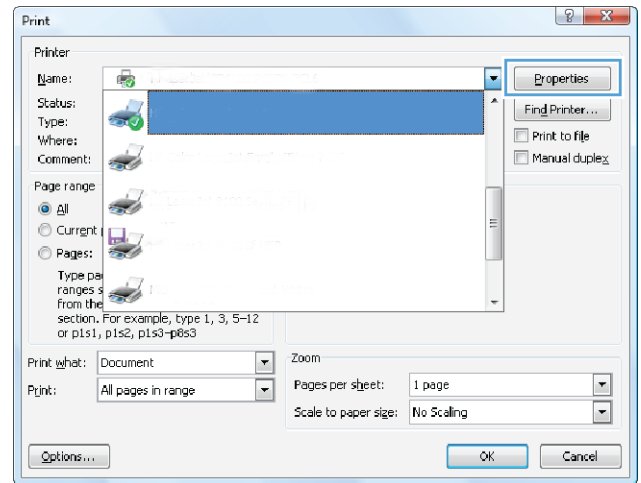

3. Click the **Effects** tab.

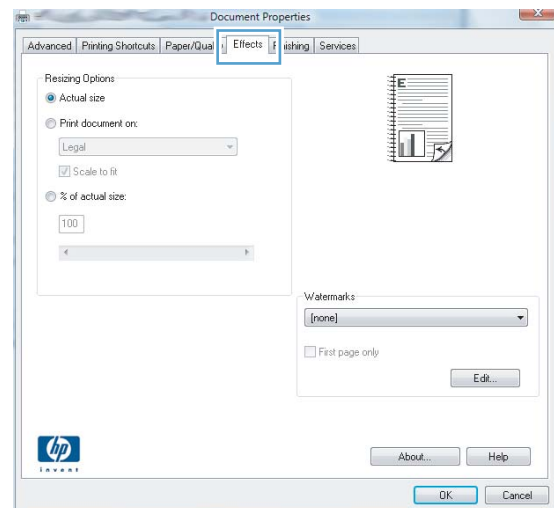

4. Select the **Print document on** option, and then select a size from the drop-down list.

Click the **OK** button to close the **Document Properties** dialog box.

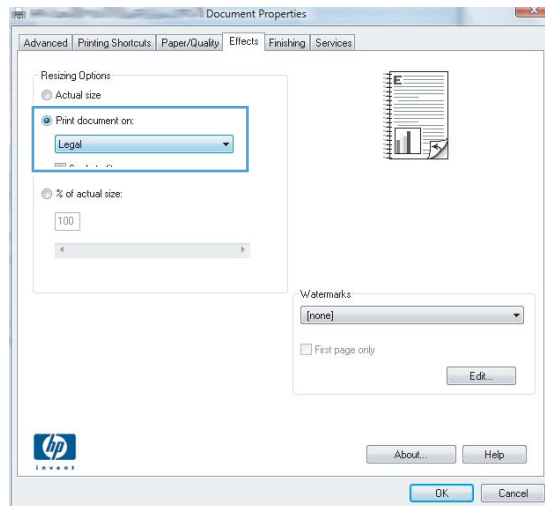

5. In the **Print** dialog box, click the **OK** button to print the job.

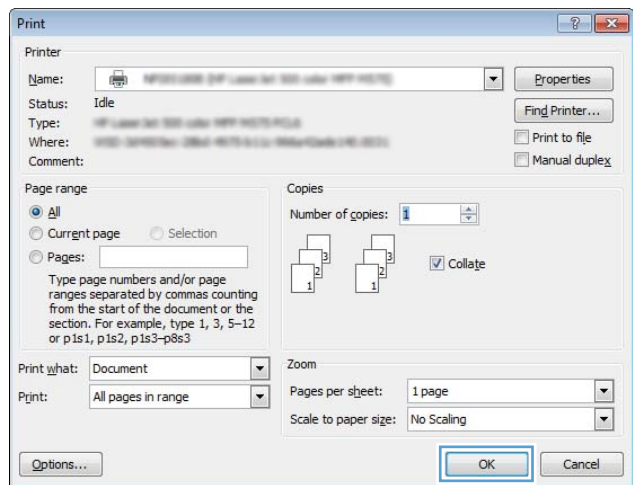

## Create a booklet (Windows)

1. From the software program, select the **Print** option.
2. Select the product, and then click the **Properties** or **Preferences** button.

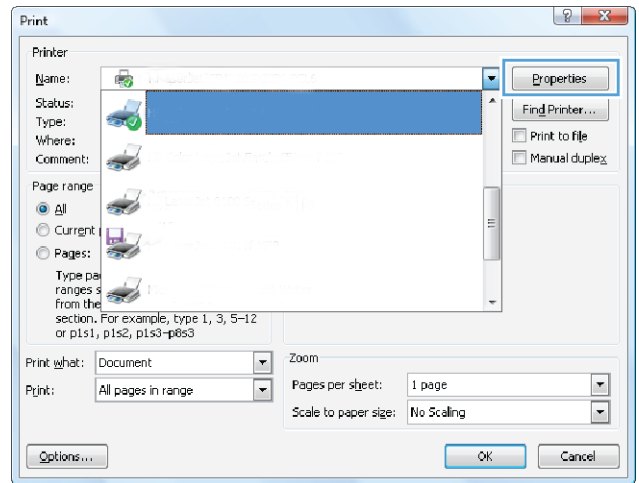

3. Click the **Finishing** tab.

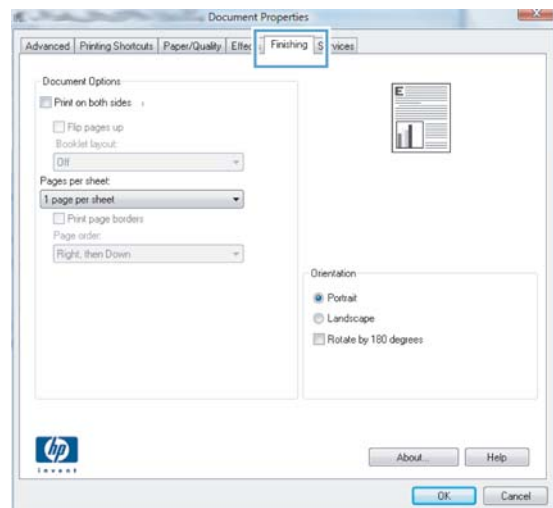

4. Select the **Print on both sides** check box.

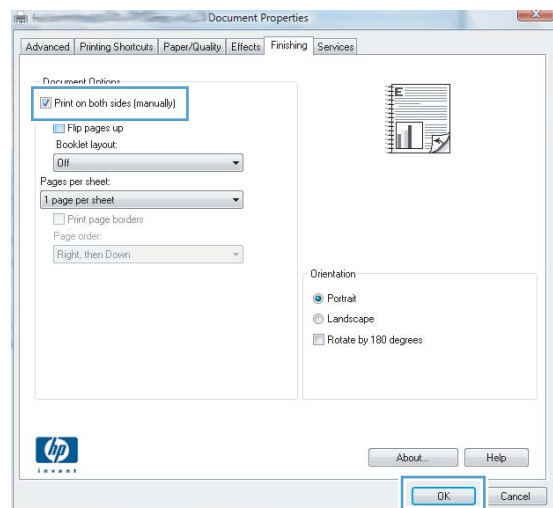

5. In the **Booklet layout** drop-down list, click the **Left binding** or **Right binding** option. The **Pages per sheet** option automatically changes to **2 pages per sheet**.

Click the **OK** button to close the **Document Properties** dialog box.

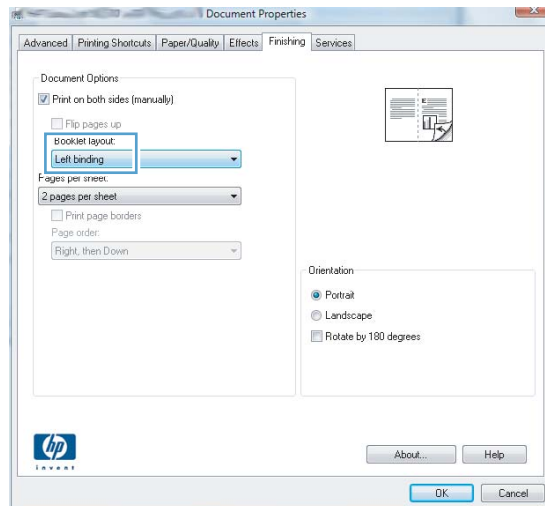

6. In the **Print** dialog box, click the **OK** button to print the job.

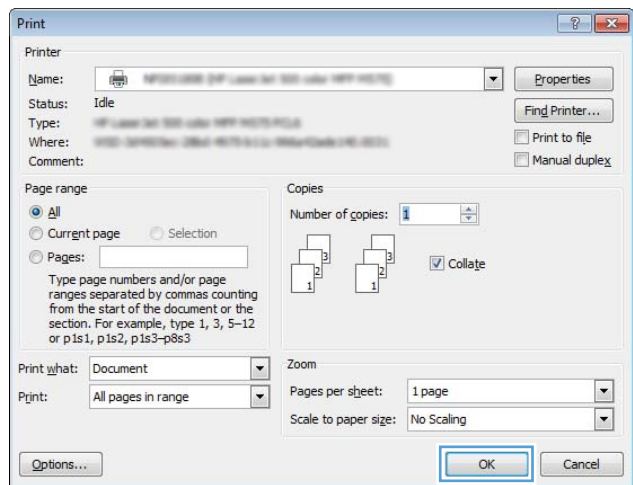

## Select the paper size (Windows)

1. From the software program, select the **Print** option.
2. Select the product, and then click the **Properties** or **Preferences** button.
3. Click the **Paper/Quality** tab.
4. Select a size from the **Paper size** drop-down list.
5. Click the **OK** button.
6. In the **Print** dialog box, click the **OK** button to print the job.

## Select a custom paper size (Windows)

1. From the software program, select the **Print** option.
2. Select the product, and then click the **Properties** or **Preferences** button.

3. Click the **Paper/Quality** tab.
4. Click the **Custom** button.
5. Type a name for the custom size and specify the dimensions.
  - The width is the short edge of the paper.
  - The length is the long edge of the paper.
6. Click the **Save** button, and then click the **Close** button.
7. Click the **OK** button to close the **Document Properties** dialog box. In the **Print** dialog box, click the **OK** button to print the job.

## Print watermarks (Windows)

1. From the software program, select the **Print** option.
2. Select the product, and then click the **Properties** or **Preferences** button.
3. Click the **Effects** tab.
4. Select a watermark from the **Watermarks** drop-down list.

Or, to add a new watermark to the list, click the **Edit** button. Specify the settings for the watermark, and then click the **OK** button.
5. To print the watermark on the first page only, select the **First page only** check box. Otherwise, the watermark is printed on each page.
6. Click the **OK** button to close the **Document Properties** dialog box. In the **Print** dialog box, click the **OK** button to print the job.

## Cancel a print job (Windows)

1. If the print job is currently printing, cancel it by pressing the Cancel **X** button on the product control panel.



**NOTE:** If the print job is too far into the printing process, you might not have the option to cancel it.



**NOTE:** Pressing the Cancel **X** button clears the job that the product is currently processing. If more than one process is running, pressing the Cancel **X** button clears the process that currently displays on the product control panel.

2. You can also cancel a print job from a software program or a print queue.
  - **Software program:** Typically, a dialog box displays briefly on the computer screen, allowing you to cancel the print job.
  - **Windows print queue:** If a print job is waiting in a print queue (computer memory) or print spooler, delete the job there.
    - **Windows XP, Server 2003, or Server 2008:** Click **Start**, click **Settings**, and then click **Printers and Faxes**. Double-click the product icon to open the window, right-click the print job that you want to cancel, and then click **Cancel**.
    - **Windows Vista:** Click the Windows icon in the lower left corner of the screen, click **Settings**, and then click **Printers**. Double-click the product icon to open the window, right-click the print job that you want to cancel, and then click **Cancel**.
    - **Windows 7:** Click the Windows icon in the lower left corner of the screen, and then click **Devices and Printers**. Double-click the product icon to open the window, right-click the print job that you want to cancel, and then click **Cancel**.

## Print tasks (Mac OS X)

- [Use a printing preset \(Mac OS X\)](#)
- [Create a printing preset \(Mac OS X\)](#)
- [Automatically print on both sides \(Mac OS X\)](#)
- [Manually print on both sides \(Mac OS X\)](#)
- [Print multiple pages per sheet \(Mac OS X\)](#)
- [Select the page orientation \(Mac OS X\)](#)
- [Select the paper type \(Mac OS X\)](#)
- [Print a cover page \(Mac OS X\)](#)
- [Scale a document to fit page size \(Mac OS X\)](#)
- [Create a booklet \(Mac OS X\)](#)
- [Select the paper size \(Mac OS X\)](#)
- [Select a custom paper size \(Mac OS X\)](#)
- [Print watermarks \(Mac OS X\)](#)
- [Cancel a print job \(Mac OS X\)](#)

### Use a printing preset (Mac OS X)

1. Click the **File** menu, and then click the **Print** option.
2. In the **Printer** menu, select the product.
3. In the **Presets** menu, select the printing preset.
4. Click the **Print** button.



---

**NOTE:** To use print-driver default settings, select the **standard** option.

---

### Create a printing preset (Mac OS X)

Use printing presets to save the current print settings for reuse.

1. Click the **File** menu, and then click the **Print** option.
2. In the **Printer** menu, select the product.
3. By default, the print driver displays the **Copies & Pages** menu. Open the menus drop-down list, and then open a menu for which you want to change the print settings.
4. For each menu, select the print settings that you want to save for reuse.

5. In the **Presets** menu, click the **Save As...** option, and enter a name for the preset.
6. Click the **OK** button.

## Automatically print on both sides (Mac OS X)

The product supports the following paper sizes for automatic duplex printing:

- Letter
- Legal
- A4
- 8.5 x 13

The product supports the following paper types for automatic duplex printing:

- Unspecified
- Plain
- HP EcoSMART Lite
- Light 60–74 g
- Midweight 96–110 g
- Letterhead
- Preprinted
- Prepunched
- Colored
- Bond
- Recycled

For other paper types or sizes, use manual duplex printing.

1. Click the **File** menu, and then click the **Print** option.
2. In the **Printer** menu, select the product.
3. By default, the print driver displays the **Copies & Pages** menu. Open the menus drop-down list, and then click the **Layout** menu.
4. Select a binding option from the **Two-Sided** drop-down list.
5. Click the **Print** button.



## Manually print on both sides (Mac OS X)

1. Click the **File** menu, and then click the **Print** option.
2. In the **Printer** menu, select this product.
3. By default, the print driver displays the **Copies & Pages** menu. Open the menus drop-down list, and then click the **Manual Duplex** menu.
4. Click the **Manual Duplex** box, and select a binding option.
5. Click the **Print** button.
6. Go to the product, and remove any blank paper that is in Tray 1.
7. Retrieve the printed stack from the output bin and place it with the printed-side facing down in the input tray.



**NOTE:** Do not rotate or turn over the pages.

---

8. If prompted, touch the appropriate control panel button to continue.

## Print multiple pages per sheet (Mac OS X)

1. Click the **File** menu, and then click the **Print** option.
2. In the **Printer** menu, select the product.
3. By default, the print driver displays the **Copies & Pages** menu. Open the menus drop-down list, and then click the **Layout** menu.
4. From the **Pages per Sheet** drop-down list, select the number of pages that you want to print on each sheet.
5. In the **Layout Direction** area, select the order and placement of the pages on the sheet.
6. From the **Borders** menu, select the type of border to print around each page on the sheet.
7. Click the **Print** button.

## Select the page orientation (Mac OS X)

1. Click the **File** menu, and then click the **Print** option.
2. In the **Printer** menu, select the product.
3. In the **Copies & Pages** menu, click the **Page Setup** button.
4. Click the icon that represents the page orientation that you want to use, and then click the **OK** button.
5. Click the **Print** button.

## Select the paper type (Mac OS X)

1. Click the **File** menu, and then click the **Print** option.
2. In the **Printer** menu, select the product.
3. By default, the print driver displays the **Copies & Pages** menu. Open the menus drop-down list, and then click the **Finishing** menu.
4. Select a type from the **Media-type** drop-down list.
5. Click the **Print** button.

## Print a cover page (Mac OS X)

1. Click the **File** menu, and then click the **Print** option.
2. In the **Printer** menu, select the product.
3. By default, the print driver displays the **Copies & Pages** menu. Open the menus drop-down list, and then click the **Cover Page** menu.
4. Select where to print the cover page. Click either the **Before Document** button or the **After Document** button.
5. In the **Cover Page Type** menu, select the message that you want to print on the cover page.



**NOTE:** To print a blank cover page, select the **standard** option from the **Cover Page Type** menu.

6. Click the **Print** button.

## Scale a document to fit page size (Mac OS X)

1. Click the **File** menu, and then click the **Print** option.
2. In the **Printer** menu, select the product.
3. By default, the print driver displays the **Copies & Pages** menu. Open the menus drop-down list, and then click the **Paper Handling** menu.
4. In the **Destination Paper Size** area, click the **Scale to fit paper size** box, and then select the size from the drop-down list.
5. Click the **Print** button.

## Create a booklet (Mac OS X)

1. Click the **File** menu, and then click the **Print** option.
2. In the **Printer** menu, select the product.
3. By default, the print driver displays the **Copies & Pages** menu. Open the menus drop-down list, and then click the **Layout** menu.

4. Select a binding option from the **Two-Sided** drop-down list.
5. Open the menus drop-down list, and then click the **Booklet Printing** menu.
6. Click the **Format Output as Booklet** box, and select a binding option.
7. Select the paper size.
8. Click the **Print** button.

## Select the paper size (Mac OS X)

1. Click the **File** menu, and then click the **Print** option.
2. In the **Printer** menu, select the product.
3. In the **Copies & Pages** menu, click the **Page Setup** button.
4. Select a size from the **Paper Size** drop-down list, and then click the **OK** button.
5. Click the **Print** button.

## Select a custom paper size (Mac OS X)

1. Click the **File** menu, and then click the **Print** option.
2. In the **Printer** menu, select the product.
3. In the **Copies & Pages** menu, click the **Page Setup** button.
4. From the **Paper Size** drop-down list, select the **Manage Custom Sizes** option.
5. Specify the dimensions for the page size, and then click the **OK** button.
6. Click the **OK** button to close the **Page Setup** dialog.
7. Click the **Print** button.

## Print watermarks (Mac OS X)

1. Click the **File** menu, and then click the **Print** option.
2. In the **Printer** menu, select the product.
3. By default, the print driver displays the **Copies & Pages** menu. Open the menus drop-down list, and then click the **Watermarks** menu.
4. From the **Mode** menu, select the **Watermark** option.
5. From the **Pages** drop-down list, select whether to print the watermark on all pages or on the first page only.
6. From the **Text** drop-down list, select one of the standard messages, or select the **Custom** option and type a new message in the box.



7. Select options for the remaining settings.
8. Click the **Print** button.

## Cancel a print job (Mac OS X)

1. If the print job is currently printing, cancel it by pressing the Cancel  button on the product control panel.

---

 **NOTE:** If the print job is too far into the printing process, you might not have the option to cancel it.

 **NOTE:** Pressing the Cancel  button clears the job that the product is currently processing. If more than one print job is waiting, pressing the Cancel  button clears the print job that currently displays on the product control panel.

---

2. You can also cancel a print job from a software program or a print queue.
  - **Software program:** Typically, a dialog box displays briefly on the computer screen, allowing you to cancel the print job.
  - **Mac print queue:** Open the print queue by double-clicking the product icon in the dock. Highlight the print job, and then click **Delete**.

# Create archival-quality prints

Archive print produces output that is less susceptible to toner smearing and dusting. Use archive print to create documents that you want to preserve or archive.

---

 **NOTE:** Archival-quality printing is accomplished by increasing the temperature of the fuser. Because of the increased temperatures, the product prints at half-speed to avoid damage.

---

1. From the Home screen on the product control panel, touch the Setup  button.
2. Touch the [Service](#) menu.
3. Touch the [Archive Print](#) button, and then touch the [On](#) button.

# Use HP ePrint

Use HP ePrint to print documents by sending them as an email attachment to the product's email address from any email enabled device.



**NOTE:** The product must be connected to a wired or wireless network and have Internet access to use HP ePrint.

1. To use HP ePrint, you must first enable HP Web Services.
  - a. From the Home screen on the product control panel, touch the Web Services button.
  - b. Touch the [Enable Web Services](#) button.
2. From the [HP Web Services](#) menu, touch the [Display E-Mail Address](#) button to display the product's email address on the control panel.
3. Use the HP ePrintCenter Web site to define security settings and to configure default print settings for all HP ePrint jobs sent to this product.

- a. Go to [www.hpeprintcenter.com](http://www.hpeprintcenter.com).
- b. Click **Sign In**, and enter your HP ePrintCenter credentials or sign up for a new account.
- c. Select your product from the list, or click **+ Add printer** to add it. To add the product, you need the printer code, which is the segment of the product email address that is before the @ symbol. You can get this code by printing the Web Services page from the product control panel.

After you have added your product, you will have the option to customize the product email address.



**NOTE:** This code is valid for only 24 hours from the time you enable HP Web Services. If it expires, follow the instructions to enable HP Web Services again, and obtain a new code.

- d. To prevent your product from printing unexpected documents, click **ePrint Settings**, and then click the **Allowed Senders** tab. Click **Allowed Senders Only**, and add the email addresses from which you want to allow ePrint jobs.
  - e. To set up default settings for all ePrint jobs sent to this product, click **ePrint Settings**, click **Print Options**, and select the settings that you want to use.
4. To print a document, attach it to an email message sent to the product's email address. Both the email message and the attachment will print.

## Use AirPrint

Direct printing using Apple's AirPrint is supported for iOS 4.2 or later. Use AirPrint to print directly to the product from an iPad (iOS 4.2), iPhone (3GS or later), or iPod touch (third generation or later) in the following applications:

- Mail
- Photos
- Safari
- Select third-party applications

To use AirPrint, the product must be connected to a network. For more information about using AirPrint and about which HP products are compatible with AirPrint, go to [www.hp.com/go/airprint](http://www.hp.com/go/airprint).



**NOTE:** You might need to upgrade the product firmware to use AirPrint. Go to [www.hp.com/go/ljmfpm521series\\_firmware](http://www.hp.com/go/ljmfpm521series_firmware).

## Use walk-up USB printing

1. Insert the USB flash drive into the USB port on the front of the product.

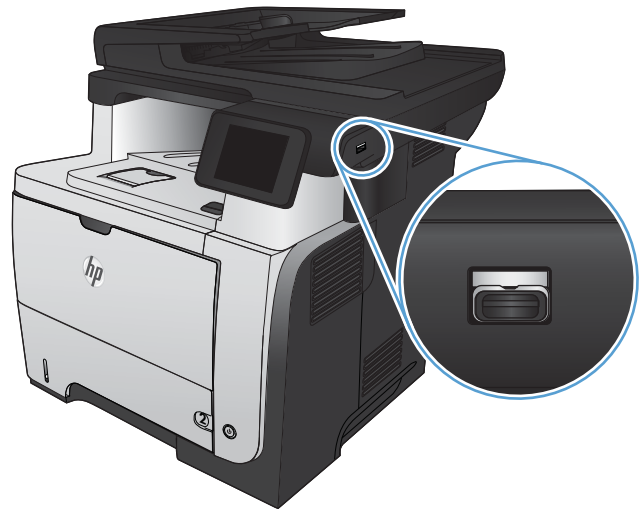

2. The **USB Flash Drive** menu opens. Touch the arrow buttons to scroll through the options.
  - **Print Documents**
  - **View and Print Photos**
  - **Scan to USB Drive**
3. To print a document, touch the **Print Documents** screen, and then touch the name of the folder on the USB drive where the document is stored. When the summary screen opens, you can touch it to adjust the settings. Touch the **Print** button to print the document.
4. To print photos, touch the **View and Print Photos** screen, and then touch the preview image to select each photo that you want to print. Touch the **Done** button. When the summary screen opens, you can touch it to adjust the settings. Touch the **Print** button to print the photos.
5. Retrieve the printed job from the output bin, and remove the USB flash drive.



---

# 5 Copy

- [Set new default copy settings](#)
- [Restore copy default settings](#)
- [Make a single copy](#)
- [Make multiple copies](#)
- [Copy a multiple-page original](#)
- [Copy identification cards](#)
- [Collate a copy job](#)
- [Copy on both sides \(duplex\)](#)
- [Reduce or enlarge a copy](#)
- [Optimize copy quality](#)
- [Adjust the lightness or darkness for copies](#)
- [Copy in draft mode](#)
- [Set the paper size and type for copying on special paper](#)

## Set new default copy settings

You can save any combination of copy settings as the default settings to use for every job.

1. From the Home screen, touch the [Copy](#) button.
2. Touch the [Settings](#) button.
3. Configure the copy settings to meet your preferences, and then scroll to and touch the [Set as New Defaults](#) button.
4. Touch the [Yes](#) button.

## Restore copy default settings

Use this procedure to restore the factory default copy settings.

1. From the Home screen, touch the **Copy** button.
2. Touch the **Settings** button.
3. Scroll to and touch the **Restore Defaults** button.
4. Touch the **OK** button to restore the defaults.

## Make a single copy

1. Load the document onto the scanner glass or into the document feeder.

**NOTE:** If documents are in the document feeder and on the scanner glass at the same time, the product processes the document in the document feeder and not the one on the scanner glass.

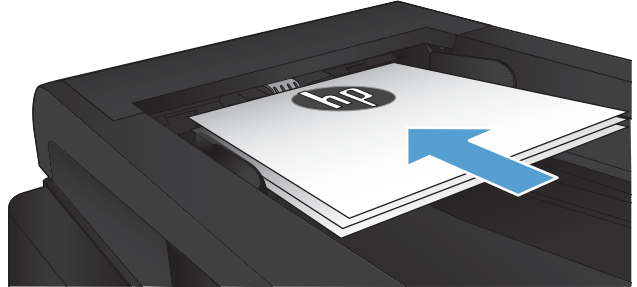

2. If you loaded the document into the document feeder, adjust the guides until they are snug against the paper.

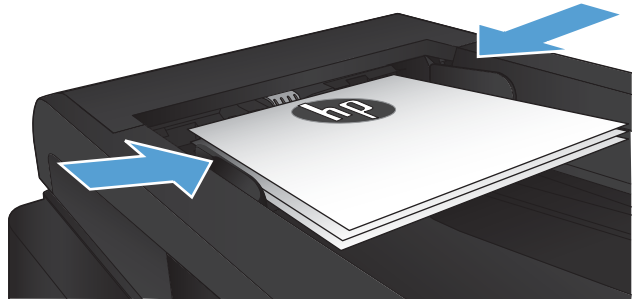

3. From the Home screen on the product control panel, touch the [Copy](#) button.
4. Touch the [Start Copy](#) button to start copying.

## Make multiple copies

1. Load the document onto the scanner glass or into the document feeder.

**NOTE:** If documents are in the document feeder and on the scanner glass at the same time, the product processes the document in the document feeder and not the one on the scanner glass.

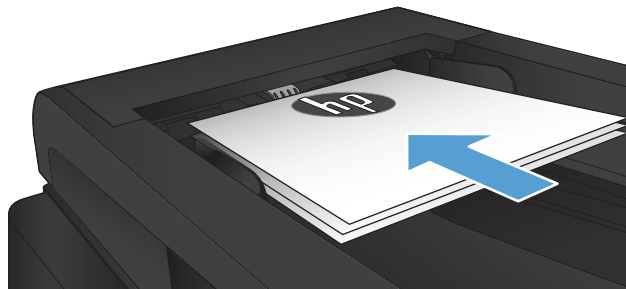

2. If you loaded the document into the document feeder, adjust the guides until they are snug against the paper.

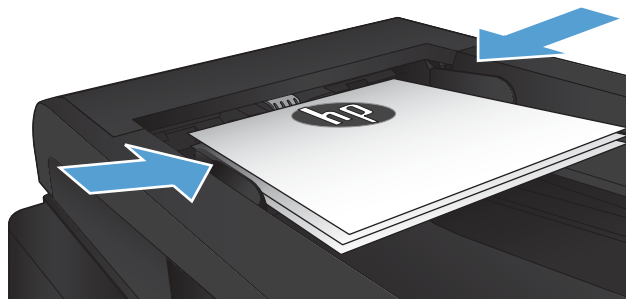

3. From the Home screen on the product control panel, touch the **Copy** button.
4. Touch the arrows to change the number of copies, or touch the existing number and enter the number of copies.
5. Touch the **Start Copy** button to start copying.

## Copy a multiple-page original

1. Insert the originals into the document feeder face-up.

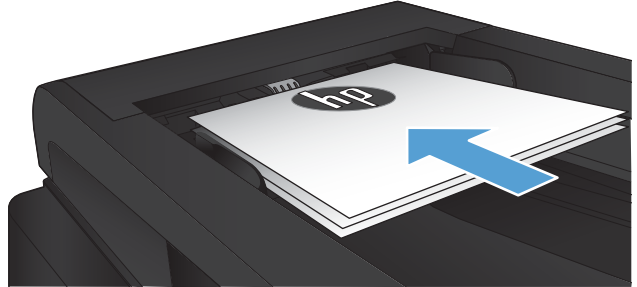

2. Adjust the guides until they are snug against the paper.

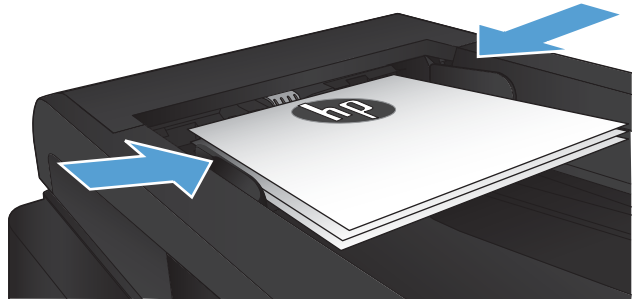

3. From the Home screen, touch the [Copy](#) button.
4. Touch the [Start Copy](#) button to start copying.

# Copy identification cards

Use the **ID Copy** feature to copy both sides of identification cards, or other small-size documents, onto the same side of one sheet of paper. The product prompts you to copy the first side and then to place the second side on a different area of the scanner glass and copy again. The product prints both images at the same time.

1. Load the document onto the scanner glass.



2. From the Home screen, touch the **Copy** button.
3. Touch the **ID Copy** button.
4. Touch the **Start Copy** button to start copying.
5. The product prompts you to place the next page on a different section of the scanner glass.



6. Touch the **OK** button if you have more pages to copy, or touch the **Done** button if this is the last page.
7. The product copies all pages onto one side of a sheet of paper.

## Collate a copy job

1. Load the document onto the scanner glass or into the document feeder.

**NOTE:** If documents are in the document feeder and on the scanner glass at the same time, the product processes the document in the document feeder and not the one on the scanner glass.

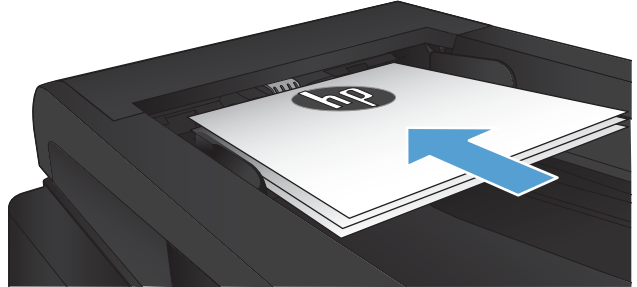

2. From the Home screen on the product control panel, touch the **Copy** button.
3. Touch the **Settings** button, and then scroll to and touch the **Collation** button. Touch the arrow buttons to scroll through the options, and then touch an option to select it.
4. Touch the **Start Copy** button to start copying.



# Copy on both sides (duplex)

## Copy on both sides automatically

1. Load the original documents into the document feeder with the first page facing up, and with the top of the page leading.

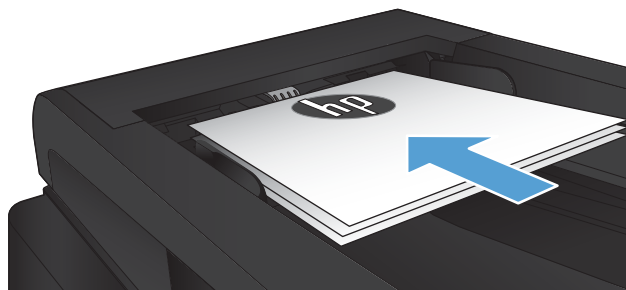

2. Adjust the paper guides to fit the size of the document.

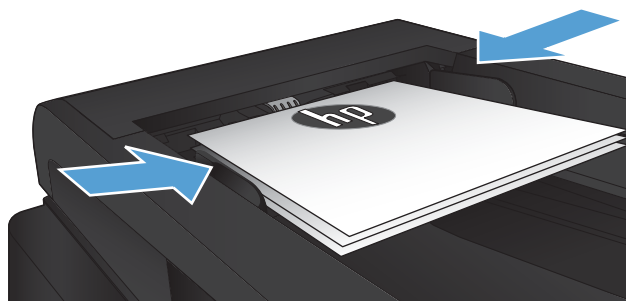

3. From the Home screen on the product control panel, touch the **Copy** button.
4. Touch the **Settings** button.
5. Scroll to and touch the **Two-Sided** button.
6. Touch the arrow buttons to scroll through the options, and then touch an option to select it.
7. Touch the **Start Copy** button to start copying.

## Copy on both sides manually

1. Place the document face-down on the scanner glass with the upper-left corner of the page in the upper-left corner of the glass. Close the scanner.

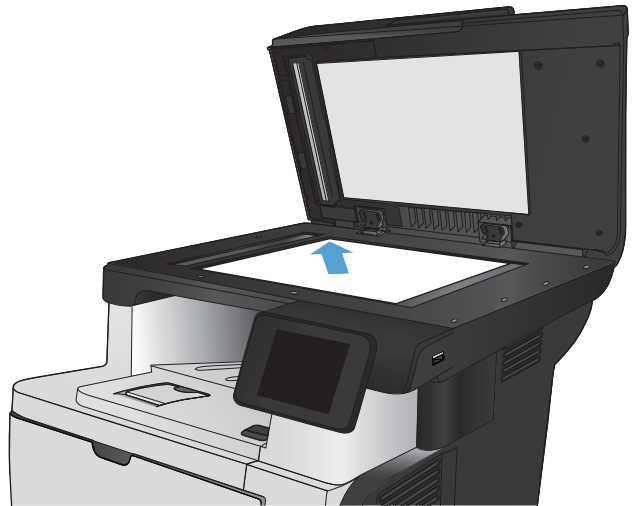

2. From the Home screen on the product control panel, touch the **Copy** button.
3. Touch the **Settings** button.
4. Scroll to and touch the **Two-Sided** button.
5. Touch the arrow buttons to scroll through the options, and then touch an option to select it.
6. Touch the **Start Copy** button to start copying.
7. The product prompts you to load the next original document. Place it on the glass, and then touch the **OK** button.
8. Repeat this process until you have scanned the last page. Touch the **Done** button to finish printing the copies.

## Reduce or enlarge a copy

1. Load the document onto the scanner glass or into the document feeder.

**NOTE:** If documents are in the document feeder and on the scanner glass at the same time, the product processes the document in the document feeder and not the one on the scanner glass.

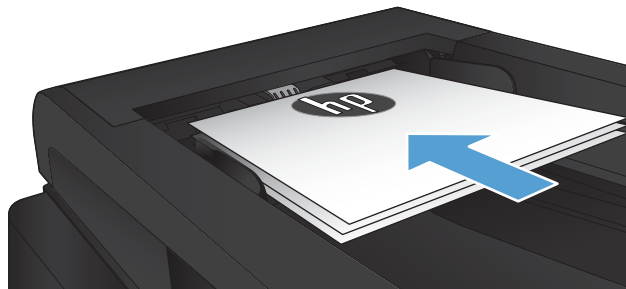

2. From the Home screen on the product control panel, touch the **Copy** button.
3. Touch the **Settings** button, and then touch the **Reduce/Enlarge** button. Touch the arrow buttons to scroll through the options, and then touch an option to select it.
4. Touch the **Start Copy** button to start copying.

# Optimize copy quality

The following copy-quality settings are available:

- **Auto Select:** Use this setting when you are not concerned about the quality of the copy. This is the default setting.
- **Mixed:** Use this setting for documents that contain a mixture of text and graphics.
- **Text:** Use this setting for documents that contain mostly text.
- **Picture:** Use this setting for documents that contain mostly graphics.

1. Load the document onto the scanner glass or into the document feeder.

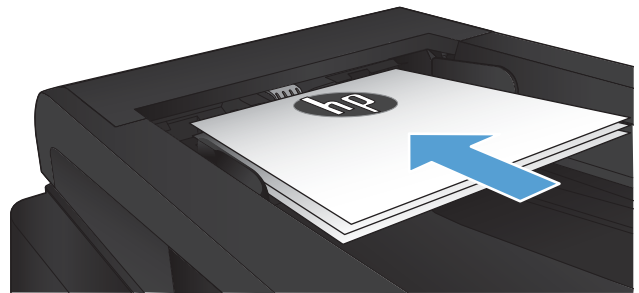

2. From the Home screen, touch the **Copy** button.
3. Touch the **Settings** button, and then scroll to and touch the **Optimize** button. Touch the arrow buttons to scroll through the options, and then touch an option to select it.
4. Touch the **Start Copy** button to start copying.

# Adjust the lightness or darkness for copies

1. Load the document onto the scanner glass or into the document feeder.

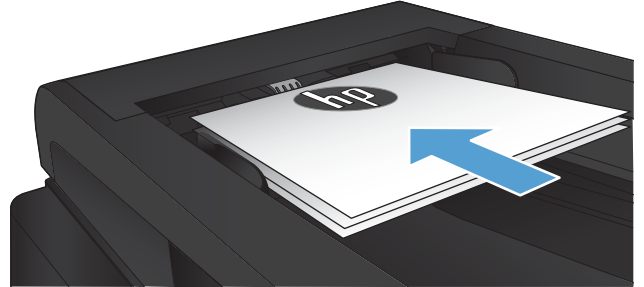

2. From the Home screen, touch the **Copy** button.
3. Touch the **Settings** button.
4. Touch the **Lighter/Darker** button.
5. Touch the “+” or “-” button to adjust the setting, and then touch the **OK** button.
6. Touch the **Start Copy** button to start copying.

## Copy in draft mode

Using draft mode can use less toner. However, using draft mode can also reduce print quality.

HP does not recommend the full-time use of draft mode. If draft mode is used full-time, the toner supply might outlast the mechanical parts in the toner cartridge. If print quality begins to degrade and is no longer acceptable, consider replacing the toner cartridge.

1. Load the document onto the scanner glass or into the document feeder.

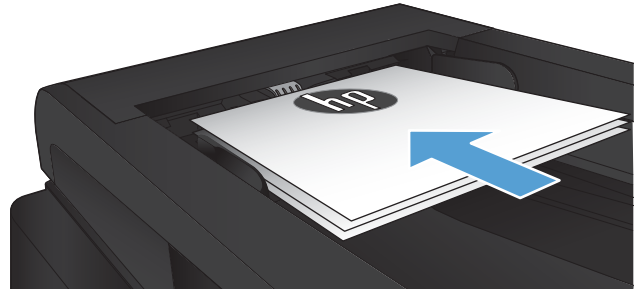

2. From the Home screen, touch the [Copy](#) button.
3. Touch the [Settings](#) button.
4. Scroll to and touch the [Draft Mode](#) button.
5. Touch the [On](#) button.
6. Touch the [Start Copy](#) button to start copying.

# Set the paper size and type for copying on special paper

1. From the Home screen, touch the [Copy](#) button.
2. Touch the [Settings](#) button, and then scroll to and touch the [Paper](#) button.
3. From the list of paper sizes, touch the name of the paper size that is in Tray 1.



---

**NOTE:** The product supports these sizes for copying: Letter, Legal, and A4.

---

4. From the list of paper types, touch the name of the paper type that is in Tray 1.
5. Touch the [Start Copy](#) button to start copying.





---

# 6 Scan

- [Scan by using the HP Scan software \(Windows\)](#)
- [Scan by using the HP Scan software \(Mac OS X\)](#)
- [Scan to a USB flash drive](#)
- [Set up scan to network folder and scan to email features](#)
- [Scan to a network folder](#)
- [Scan to email](#)
- [Scan by using other software](#)

## Scan by using the HP Scan software (Windows)

1. Double-click the **HP Scan** icon on the computer desktop. If the icon is not on the computer desktop, open the **Programs** folder, click **HP**, open the folder for this product, and then click **HP Scan**.
2. Select a scanning shortcut, and adjust the settings if necessary.
3. Click **Scan**.



**NOTE:** Click **Advanced Settings** to gain access to more options.

Click **Create New Shortcut** to create a customized set of settings and save it in the list of shortcuts.

## Scan by using the HP Scan software (Mac OS X)

1. Open the **HP Scan** software, which is located in the **Hewlett-Packard** folder inside the **Applications** folder.
2. Follow the on-screen instructions to scan the document.
3. When you have scanned all the pages, click the **Send** button to print the pages or save them to a file.

## Scan to a USB flash drive

1. Load the document onto the scanner glass or into the document feeder.
2. Insert a USB flash drive into the port on the front of the product.
3. From the Home screen on the product control panel, touch the [Scan](#) button.
4. Touch the [Scan to USB Drive](#) screen.
5. Touch the [Scan](#) button to scan and save the file. The product creates a folder named **HPSCANS** on the USB drive, and it saves the file in .PDF or .JPG format using an automatically generated file name.



**NOTE:** When the summary screen opens, you can touch it to adjust settings.



You also can change the folder name.

---



# Set up scan to network folder and scan to email features

To use these scan features, the product must be connected to a network. These scan features are not available until you configure them. Use the Scan to Network Folder Setup Wizard (Windows) and the Scan to Email Wizard (Windows) at the end of the product software installation process, or use the HP Embedded Web Server to configure these features. The following instructions describe configuring the scan features by using the HP Embedded Web Server.

## Configure the scan to network folder feature

1. From the Home screen on the product control panel, touch the Network  button to find the product IP address.
  2. To open the HP Embedded Web Server, enter the product IP address into the address line of a Web browser.
- 
-  **NOTE:** You can also access the HP Embedded Web Server from the HP Device Toolbox for Windows or the HP Utility for Mac OS X.
- 
3. Click the **Scan** tab.
  4. Click the **Scan to Network Folder Setup** link in the left pane of the screen.
  5. To set up a new folder, click the **New** button.
  6. Complete the fields on this screen.
  7. Click the **Save and Test** button at the bottom of the screen to save the settings and test the setup.

## Configure the scan to email feature

1. From the Home screen on the product control panel, touch the Network  button to find the product IP address.
  2. To open the HP Embedded Web Server, enter the product IP address into the address line of a Web browser.
- 
-  **NOTE:** You can also access the HP Embedded Web Server from the HP Device Toolbox for Windows or the HP Utility for Mac OS X.
- 
3. Click the **Scan** tab.
  4. Click the **Scan to E-mail Setup** link in the left pane of the screen.
  5. Click the **Outgoing E-mail Profiles** link, and then click the **New** button.
  6. Complete the fields on this screen. Ask your network administrator or your Internet service provider for the SMTP Server information. If the SMTP server requires authentication, you also need to know the SMTP User ID and password.

7. Click the **Save and Test** button at the bottom of the screen to save the settings and test the setup.
8. You can add contacts to the Email Address Book or configure other default Email Settings. These steps are optional. Click the **E-mail Address Book** link and the **E-mail Options** links in the left pane of the screen to set up these features.

## Scan to a network folder

Use the product control panel to scan a document and save it to a folder on the network.



**NOTE:** In order to use this feature, the product must be connected to a network and the scan feature must be configured using the HP Embedded Web Server.

---

1. Load the document onto the scanner glass or into the document feeder.
2. From the Home screen on the product control panel, touch the [Scan](#) button.
3. Touch the [Scan to Network Folder](#) item.
4. In the list of network folders, select the folder to which you want to save the document.
5. The control panel screen displays the scan settings.
  - If you want to change any of the settings, touch the [Settings](#) button, and then change the settings.
  - If the settings are correct, go to the next step.
6. Touch the [Scan](#) button to start the scan job.

# Scan to email

Use the product control panel to scan a file directly to an email address. The scanned file is sent to the address as an email message attachment.



---

**NOTE:** In order to use this feature, the product must be connected to a network and the scan feature must be configured using the HP Embedded Web Server.

---

1. Load the document onto the scanner glass or into the document feeder.
2. From the Home screen on the product control panel, touch the [Scan](#) button.
3. Touch the [Scan to E-mail](#) item.
4. Touch the [Send an E-mail](#) item.
5. Select the [From](#) address that you want to use. This is also known as an “outgoing email profile.”



---

**NOTE:** If the PIN feature has been set up, enter the PIN and touch the [OK](#) button. However, a PIN is not required to use this feature.

---

6. Touch the [To](#) button and pick the address or group to which you want to send the file. Touch the [Done](#) button when finished.
7. Touch the [Subject](#) button if you would like to add a subject line
8. Touch the [Next](#) button.
9. The control panel screen displays the scan settings.
  - If you want to change any of the settings, touch the [Settings](#) button, and then change the settings.
  - If the settings are correct, go to the next step.
10. Touch the [Scan](#) button to start the scan job.



## Scan by using other software

If you install the full product software, the product is TWAIN-compliant and Windows Imaging Application (WIA)-compliant. If you install the minimum product software, the product is WIA-compliant. The product works with Windows-based programs that support TWAIN-compliant or WIA-compliant scanning devices.

While you are in a TWAIN-compliant or WIA-compliant program, you can gain access to the scanning feature and scan an image directly into the open program. For more information, see the Help file or the documentation that came with your TWAIN-compliant or WIA-compliant software program.

### Scan from a TWAIN-compliant program (Windows)

Generally, a software program is TWAIN-compliant if it has a command such as **Acquire, File Acquire, Scan, Import New Object, Insert from, or Scanner**. If you are unsure whether the program is compliant or you do not know what the command is called, see the software program Help or documentation.

When scanning from a TWAIN-compliant program, the HP Scan software program might start automatically. If the HP Scan program starts, you can make changes while previewing the image. If the program does not start automatically, the image goes to the TWAIN-compliant program immediately.

Start the scan from within the TWAIN-compliant program. See the software program Help or documentation for information about the commands and steps to use.

### Scan from a WIA-compliant program (Windows)

WIA is another way to scan an image directly into a software program. WIA uses Microsoft software to scan, instead of the HP Scan software.

Generally, a software program is WIA-compliant if it has a command such as **Picture/From Scanner or Camera** in the Insert or File menu. If you are unsure whether the program is WIA-compliant, see the software program Help or documentation.

Start the scan from within the WIA-compliant program. See the software program Help or documentation for information about the commands and steps to use.

**-Or-**

From the Windows control panel, in the **Cameras and Scanner** folder (located inside the **Hardware and Sound** folder for Windows Vista and Windows 7), double-click the product icon. This opens the standard Microsoft WIA Wizard, which enables you to scan to a file.



---

# 7 Fax

- [Set up the product for fax](#)
- [Use the phone book](#)
- [Configure send fax settings](#)
- [Configure receive fax settings](#)
- [Set fax polling](#)
- [Use fax](#)

# Set up the product for fax

## Connect the fax port to a telephone line

1. Connect the telephone cable to the fax port on the product and to the telephone jack on the wall.

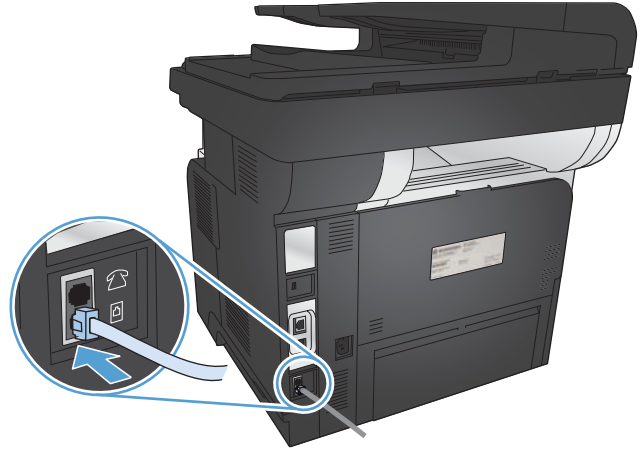



The product is an analog device. HP recommends using the product on a dedicated analog telephone line.

 **NOTE:** Some countries/regions might require an adapter to the telephone cable that came with the product.

## Connect additional devices

The product includes two fax ports:

- The fax “line in” port , which connects the product to the wall telephone jack.
- The fax “telephone line out” port , which connects additional devices to the product.

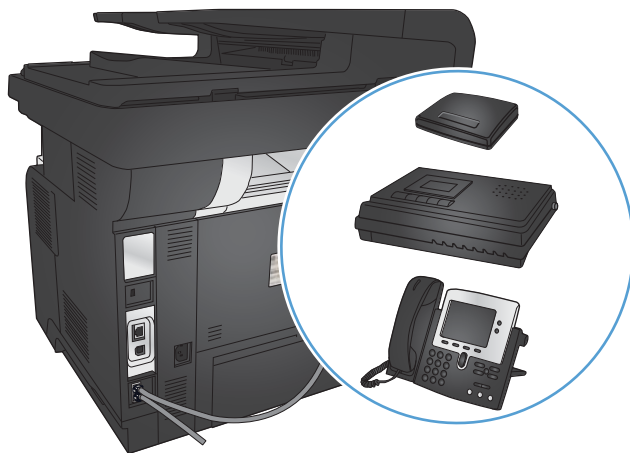



Telephones used in conjunction with the product can be employed in two ways:

- An extension phone is connected to the same phone line at another location.
- A downstream phone is connected to the product or to another device that is connected to the product.



Connect additional devices in the order that is described in the following steps. The output port for each device is connected to the input port of the next, forming a "chain". If you do not want to connect a specific device, skip the step that explains it and continue to the next device.

---

 **NOTE:** Do not connect more than three devices to the telephone line.

 **NOTE:** Voicemail is not supported with this product.

---

1. Disconnect the power cords for all of the devices that you want to connect.
2. Connect the product to a telephone jack.
3. Remove the plastic insert from the "telephone line out" port .
4. To connect an internal or external modem on a computer, connect one end of a telephone cord into the product "telephone line out" port . Connect the other end of the telephone cord into the fax "line in" port  on the modem or computer.

---

 **NOTE:** Some modems have a second "line" port to connect to a dedicated voice line. If you have two "line" ports, see your modem documentation to make sure that you connect to the correct "line" port.

---

5. To connect a caller-ID box, connect a telephone cord into the previous device's "telephone" port. Connect the other end of the telephone cord into the caller-ID box "line" port.
6. To connect an answering machine, connect a telephone cord into the previous device's "telephone" port. Connect the other end of the telephone cord into the answering machine "line" port.
7. To connect a telephone, connect a telephone cord into the previous device's "telephone" port. Connect the other end of the telephone cord into the telephone "line" port.
8. After you have finished connecting additional devices, connect all of the devices to their power sources.

## Set up fax with a telephone answering machine

If you connect a telephone answering machine to the product, follow these steps to configure the product:

---

 **NOTE:** If an answering machine is connected to the same telephone line but on a different jack (in another room, for example), it might interfere with the product's ability to receive faxes.

---

1. From the Home screen on the product control panel, touch the Setup  button.
2. Touch the **Fax Setup** button.



3. Touch the **Basic Setup** button.
4. Touch the **Rings to Answer** button.
5. Set the product rings-to-answer setting for at least one ring more than the number of rings for which the answering machine is set. Use the keypad to enter the number of rings, and then touch the **OK** button.
6. Touch the back  button to return to the **Basic Setup** menu.
7. Scroll to and touch the **Answer Mode** button.
8. Touch the **TAM** button. With this setting, the product listens for fax tones after the answering machine has picked up the call. The product picks up a call if fax tones are detected.

## Set up fax with an extension phone

If you connect an extension phone to the product, follow these steps to configure the product:

1. On the control panel, touch the Setup  button.
2. Scroll to and touch the **Fax Setup** button.
3. Scroll to and touch the **Advanced Setup** button.
4. Scroll to and touch the **Extension Phone** button, and confirm that the **On** option is selected.

With this setting turned on, you can alert the product to pick up the incoming fax call by pressing 1-2-3 sequentially on the telephone keypad. Turn this setting off only if you use pulse dialing or if you have a service from your telephone company that also uses the 1-2-3 sequence. The telephone company service does not work if it conflicts with the product.

5. Touch the back  button twice to return to the **Fax Setup** menu.
6. Touch the **Basic Setup** button.
7. Scroll to and touch the **Answer Mode** button.
8. Touch the **Fax/Tel** button. With this setting, the product automatically picks up all calls and determines if the call is a voice or fax call. If the call is a fax call, the product handles the call as an incoming fax. If the incoming call is detected as a voice call, the product generates an audible synthesized ring to alert you of an incoming voice call.
9. Touch the back  button twice to return to the **Fax Setup** menu.
10. Scroll to and touch the **Advanced Setup** button.
11. Scroll to and touch the **Fax/Tel Ring Time** button.
12. Select the number of seconds after which the product should stop sounding the Fax/Tel audible ring to notify you of an incoming voice call.

## Set up for stand-alone fax

You can use the product as a stand-alone fax machine without connecting it to a computer or a network.

1. Unpack and set up the product.
2. From the Home screen on the product control panel, touch the Setup  button.
3. Touch the **Fax Setup** button.
4. Touch the **Fax Set-Up Utility** button.
5. Follow the on-screen prompts and select the appropriate response for each question.

---

 **NOTE:** The maximum number of characters for the fax number is 20.

 **NOTE:** The maximum number of characters for the fax header is 25.

---

## Configure the fax time, date, and header

If you did not complete the fax setup process at the time you installed the software, you can complete it at any time by using one of these methods.

### Use the control panel to set the fax time, date, and header

1. From the Home screen on the product control panel, touch the Setup  button.
2. Touch the **Fax Setup** button.
3. Touch the **Basic Setup** button.
4. Scroll to and touch the **Time/Date** button.
5. Select the 12-hour clock or 24-hour clock.
6. Use the keypad to enter the current time, and then touch the **OK** button.
7. Select the date format.
8. Use the keypad to enter the current date, and then touch the **OK** button.
9. Touch the **Fax Header** button.
10. Use the keypad to enter your fax number, and then touch the **OK** button.

---

 **NOTE:** The maximum number of characters for the fax number is 20.

---

11. Use the keypad to enter your company name or header, and then touch the **OK** button.

To enter special characters that are not on the standard keypad, touch the **123** button to open a keypad that contains special characters.

---

 **NOTE:** The maximum number of characters for the fax header is 25.

---

## Use the HP Fax Setup Wizard to set the fax time, date, and header (Windows)

1. Click **Start**, and then click **Programs**.
2. Click **HP**, click the name of the product, and then click **HP Fax Setup Wizard**.
3. Follow the on-screen instructions in the HP Fax Setup Wizard to configure the fax settings.



# Use the phone book

You can store frequently dialed fax numbers (up to 120 entries) as speed-dial entries. Speed-dial entries can be individual fax numbers or groups of fax numbers.

- [Create and edit speed-dial entries](#)
- [Create and edit group-dial entries](#)
- [Delete speed-dial entries](#)
- [Delete group-dial entries](#)

## Create and edit speed-dial entries

1. From the Home screen on the product control panel, touch the **Fax** button.
2. Touch the **Fax Menu** button.
3. Touch the **Phone Book Setup** button.
4. Touch the **Individual Setup** button.
5. Touch an unassigned number from the list.
6. Use the keypad to enter a name for the entry, and then touch the **OK** button.
7. Use the keypad to enter the fax number for the entry, and then touch the **OK** button.

## Create and edit group-dial entries

1. Create an individual entry for each fax number that you want in the group.
  - a. From the Home screen on the product control panel, touch the **Fax** button.
  - b. Touch the **Fax Menu** button.
  - c. Touch the **Phone Book Setup** button.
  - d. Touch the **Individual Setup** button.
  - e. Touch an unassigned number from the list.
  - f. Use the keypad to enter a name for the entry, and then touch the **OK** button.
  - g. Use the keypad to enter the fax number for the entry, and then touch the **OK** button.
2. From the **Phone Book Setup** menu, touch the **Group Setup** button.
3. Touch an unassigned number from the list.
4. Use the keypad to enter a name for the group, and then touch the **OK** button.
5. Touch the name of each individual entry that you want to include in the group. When you are finished, touch the **Done Selecting** button.

## Delete speed-dial entries

1. From the Home screen on the product control panel, touch the [Fax](#) button.
2. Touch the [Fax Menu](#) button.
3. Touch the [Phone Book Setup](#) button.
4. Touch the [Delete Entry](#) button. Or, to delete all the entries, touch the [Delete All Entries](#) button.
5. Touch the entry that you want to delete.
6. Touch the [OK](#) button to confirm the deletion.

## Delete group-dial entries



1. From the Home screen on the product control panel, touch the [Fax](#) button.
2. Touch the [Fax Menu](#) button.
3. Touch the [Phone Book Setup](#) button.
4. Touch the [Delete Entry](#) button. Or, to delete all the entries, touch the [Delete All Entries](#) button.
5. Touch the entry that you want to delete.
6. Touch the [OK](#) button to confirm the deletion.

# Configure send fax settings

- [Set special dialing symbols and options](#)
- [Set the dial tone detection](#)
- [Set autoredial options](#)
- [Set light/dark and resolution](#)
- [Set billing codes](#)

## Set special dialing symbols and options

You can insert pauses into a fax number that you are dialing. Pauses are often needed when dialing internationally or connecting to an outside line.

Special symbol	Button	Description
Dialing pause		The Redial/Pause button is available on the control panel keypad for entering a fax number. You can also touch the comma button to insert a dialing pause.
Pause for dial tone		This character causes the product to wait for a dial tone before dialing the remainder of the telephone number. This button is available only in contexts where it is appropriate.
Hook flash		This character causes the product to insert a hook flash. This button is available only in contexts where it is appropriate.

## Set a dialing prefix

A dial prefix is a number or group of numbers that are automatically added to the beginning of every fax number you enter at the control panel or from the software. The maximum number of characters for a dial prefix is 50.

The default setting is **Off**. You might want to turn this setting on and enter a prefix if, for example, you have to dial a number such as 9 to get a telephone line outside of your company telephone system. While this setting is active, you can dial a fax number without the dial prefix by using manual dial.

1. From the Home screen on the product control panel, touch the Setup  button.
2. Touch the **Fax Setup** menu.
3. Touch the **Basic Setup** menu.
4. Scroll to and touch the **Dial Prefix** button, and then touch the **On** button.
5. Use the keypad to enter the prefix, and then touch the **OK** button. You can use numbers, pauses, and dialing symbols.

## Set the dial tone detection

Normally, the product begins dialing a fax number immediately. If you are using the product on the same line as your telephone, turn on the detect-dial-tone setting. This prevents the product from sending a fax while someone is on the telephone.

The factory-set default for detect dial tone is **On** for France and Hungary, and **Off** for all other countries/regions.

1. From the Home screen on the product control panel, touch the Setup  button.
2. Touch the **Fax Setup** menu.
3. Touch the **Advanced Setup** menu.
4. Scroll to and touch the **Detect Dial Tone** button, and then touch the **On** or **Off** button.

## Tone dial or pulse dial

Use this procedure to set the product to tone-dialing or pulse-dialing mode. The factory-set default is **Tone**. Do not change this setting unless you know that the telephone line cannot use tone dialing.



---

**NOTE:** The pulse-dialing option is not available in all countries/regions.

---

1. From the Home screen on the product control panel, touch the Setup  button.
2. Touch the **Fax Setup** menu.
3. Touch the **Advanced Setup** menu.
4. Scroll to and touch the **Dialing Mode** button, and then touch the **Tone** or **Pulse** button.

## Set autoretrial options

If the product was unable to send a fax because of a communication error or the receiving fax machine did not answer or was busy, the product attempts to redial based on the redial-on-busy, redial-on-no-answer, and redial-on-communication-error options.

### Set the redial-on-busy option

If this option is on, the product redials automatically if it receives a busy signal. The factory-set default for the redial-on-busy option is **On**.

1. From the Home screen on the product control panel, touch the Setup  button.
2. Touch the **Fax Setup** menu.
3. Touch the **Advanced Setup** menu.
4. Scroll to and touch the **Redial if Busy** button, and then touch the **On** or **Off** button.

## Set the redial-on-no-answer option

If this option is on, the product redials automatically if the receiving machine does not answer. The factory-set default for the redial-on-no-answer option is **Off**.

1. From the Home screen on the product control panel, touch the Setup  button.
2. Touch the **Fax Setup** menu.
3. Touch the **Advanced Setup** menu.
4. Scroll to and touch the **Redial if No Answer** button, and then touch the **On** or **Off** button.

## Set the redial-on-communication-error option

If this option is on, the product redials automatically if some sort of communication error occurs. The factory-set default for the redial-on-communication-error option is **On**.

1. From the Home screen on the product control panel, touch the Setup  button.
2. Touch the **Fax Setup** menu.
3. Touch the **Advanced Setup** menu.
4. Scroll to and touch the **Redial if Comm. Error** button, and then touch the **On** or **Off** button.

## Set light/dark and resolution

### Set the default light/dark (contrast) setting

The contrast affects the lightness and darkness of an outgoing fax as it is being sent.

The default light/dark setting is the contrast that is normally applied to items that are being faxed. The slider is set to the middle as the default setting.

1. From the Home screen on the product control panel, touch the Setup  button.
2. Touch the **Fax Setup** menu.
3. Touch the **Advanced Setup** menu.
4. Touch the **Lighter/Darker** button, and then touch one of the arrows to adjust the slider.

### Set resolution settings



**NOTE:** Increasing the resolution increases the fax file size. Larger faxes increase the send time and could exceed the available memory in the product.

The following settings are available:

- **Standard:** This setting provides the lowest quality and the fastest transmission time.
- **Fine:** This setting provides a higher resolution quality than **Standard** that is usually appropriate for text documents.

- **Superfine:** This setting is best used for documents that mix text and images. The transmission time is slower than the **Fine** setting but faster than the **Photo** setting.
- **Photo:** This setting produces the best images, but greatly increases the transmission time.

### Set the fax resolution for the current fax job

1. From the Home screen on the product control panel, touch the **Fax** button.
2. Touch the **Fax Menu** button.
3. Touch the **Send Options** button.
4. Touch the **Fax Resolution** button, and then touch one of the options.

---

 **NOTE:** The factory-set default resolution setting is **Fine**.

---

### Set the default resolution setting for all fax jobs

1. From the Home screen on the product control panel, touch the **Setup**  button.
2. Touch the **Fax Setup** menu.
3. Touch the **Advanced Setup** menu.
4. Touch the **Fax Resolution** button, and then touch one of the options.

---

 **NOTE:** The factory-set default resolution setting is **Fine**.

---

## Set billing codes

If the billing codes feature is on, the product prompts you to enter a billing code for each fax. The product increases the billing code count for each sent fax page. This includes all types of faxes except for poll-received, fax-forwarded, or computer-downloaded faxes. For an undefined group or a group-dial fax, the product increases the billing code count for each successful fax that is sent to each destination.

The factory-set default for the billing-code setting is **Off**. The billing code can be any number from 1 through 250.

### Set the billing-code setting

1. From the Home screen on the product control panel, touch the **Setup**  button.
2. Touch the **Fax Setup** menu.
3. Touch the **Advanced Setup** menu.
4. Scroll to and touch the **Billing Codes** button, and then touch the **On** button.

## Use billing codes

1. Load the document in the document feeder or on the scanner glass.
2. From the Home screen on the product control panel, touch the **Fax** button.
3. Enter the fax number, or select a speed-dial or group-dial entry.
4. Touch the **Start Fax** button.
5. Enter the billing code, and then touch the **OK** button.

## Print the billing-code report

The billing-code report is a printed list of all the fax billing codes and the total number of faxes billed to each code. This report is available only when the billing code feature is on.



---

**NOTE:** After the product prints this report, it deletes all billing data.

---

1. From the Home screen on the product control panel, touch the **Fax** button.
2. Touch the **Fax Menu** button.
3. Touch the **Fax Reports** button.
4. Scroll to and touch the **Print Billing Report** button.

# Configure receive fax settings

- [Set fax forwarding](#)
- [Set the answer mode](#)
- [Block or unblock fax numbers](#)
- [Set the number of rings-to-answer](#)
- [Set distinctive ring](#)
- [Use autoreduction for incoming faxes](#)
- [Set fax reprint settings](#)
- [Set the fax sounds volume](#)
- [Set stamp-received faxes](#)
- [Set the private receive feature](#)

## Set fax forwarding

You can set your product to forward incoming faxes to another fax number. When the fax arrives at your product, it is stored in the memory. The product then dials the fax number that you have specified and sends the fax. If the product cannot forward a fax because of an error (for example, the number is busy) and repeated redial attempts are unsuccessful, your product prints the fax.

If the product runs out of memory while receiving a fax, it terminates the incoming fax and only forwards the pages and partial pages that have been stored in the memory.

When it is using the fax-forwarding feature, the product (rather than the computer) must be receiving the faxes, and the answer mode must be set to [Automatic](#).

1. From the Home screen on the product control panel, touch the [Fax](#) button.
2. Touch the [Fax Menu](#) button.
3. Touch the [Receive Options](#) button.
4. Touch the [Forward Fax](#) button, and touch the [On](#) button.
5. Use the keypad to enter the fax-forwarding number, and then touch the [OK](#) button.

## Set the answer mode

Depending on the situation, set the product answer mode to [Automatic](#), [TAM](#), [Fax/Tel](#), or [Manual](#). The factory-set default is [Automatic](#).

- [Automatic](#): The product answers incoming calls after a specified number of rings or upon recognition of special fax tones.
- [TAM](#): The product does not automatically answer the call. Instead, it waits until it detects the fax tone.



- **Fax/Tel:** The product answers incoming calls immediately. If it detects the fax tone, it processes the call as a fax. If it does not detect the fax tone, it creates an audible ring to alert you to answer the incoming voice call.
- **Manual:** The product never answers calls without intervention. You must start the fax-receiving process yourself, either by touching the **Start Fax** button on the control panel or by picking up a telephone that is connected to that line and dialing 1-2-3.

To set or change the answer mode, complete the following steps:

1. From the Home screen on the product control panel, touch the Setup  button.
2. Touch the **Fax Setup** menu.
3. Touch the **Basic Setup** menu.
4. Scroll to and touch the **Answer Mode** button, and then touch the name of the option that you want to use.

## Block or unblock fax numbers

If you do not want to receive faxes from specific people or businesses, you can block as many as 30 fax numbers by using the control panel. When you block a fax number and someone from that number sends you a fax, the control-panel display indicates that the number is blocked, the fax does not print, and the fax is not saved in memory. Faxes from blocked fax numbers appear in the fax activity log with a “discarded” designation. You can unblock blocked fax numbers individually or all at one time.

---

 **NOTE:** The sender of a blocked fax is not notified that the fax failed.

 **NOTE:** If the sender has not configured the fax header, the number cannot be blocked.

---

1. From the Home screen on the product control panel, touch the **Fax** button.
2. Touch the **Fax Menu** button.
3. Touch the **Receive Options** button.
4. Touch the **Block Junk Faxes** button.
5. Touch the **Add Number** button.
6. Use the keypad to enter the fax number that you want to block, and then touch the **OK** button.

## Set the number of rings-to-answer

When the answer mode is set to **Automatic**, the product rings-to-answer setting determines the number of times the telephone rings before the product answers an incoming call.

If the product is connected to a line that receives both fax and voice calls (a shared line) and that also uses an answering machine, you might need to adjust the rings-to-answer setting. The number of rings-to-answer for the product must be greater than the rings-to-answer on the answering machine. This allows the answering machine to answer the incoming call and record a message if it is a voice call.

When the answering machine answers the call, the product listens to the call and automatically answers it if it detects fax tones.

The default setting for rings-to-answer is varies by country/region.

Use the following table to determine the number of rings-to-answer to use.

Type of telephone line	Recommended rings-to-answer setting
Dedicated fax line (receiving only fax calls)	Set to a number of rings within the range shown on the control-panel display. (The minimum and maximum number of rings allowed varies by country/region.)
One line with two separate numbers and a ring-pattern service	One or two rings. (If you have an answering machine or computer voicemail for the other telephone number, make sure that the product is set to a greater number of rings than the answering system. Also, use the distinctive-ring feature to differentiate between voice and fax calls.)
Shared line (receiving both fax and voice calls) with only an attached telephone	Five rings or more.
Shared line (receiving both fax and voice calls) with an attached answering machine or computer voicemail	Two rings more than the answering machine or computer voicemail.

To set or change the number of rings-to-answer, use the following steps:

1. From the Home screen on the product control panel, touch the Setup  button.
2. Touch the [Fax Setup](#) menu.
3. Touch the [Basic Setup](#) menu.
4. Touch the [Rings to Answer](#) button.
5. Use the keypad to enter the number of rings, and then touch the [OK](#) button.

## Set distinctive ring

Ring-pattern or distinctive-ring service is available through some local telephone companies. The service provides a way to have more than one telephone number on a single line. Each telephone number has a unique ring pattern, so that you can answer voice calls and the product can answer fax calls.

If you subscribe to a ring-pattern service with a telephone company, you must set the product to answer the correct ring pattern. Not all countries/regions support unique ring patterns. Contact the telephone company to determine if this service is available in your country/region.

 **NOTE:** If you do not have ring-pattern service and you change the ring-pattern settings to something other than the default, [All Rings](#), the product might not be able to receive faxes.

The settings are as follows:

- [All Rings](#): The product answers any calls that come through the telephone line.
- [Single](#): The product answers any calls that produce a single-ring pattern.

- **Double:** The product answers any calls that produce a double-ring pattern.
- **Triple:** The product answers any calls that produce a triple-ring pattern.
- **Double and Triple:** The product answers any calls that produce a double-ring or triple-ring pattern.

To change ring patterns for call answering, complete the following steps:

1. From the Home screen on the product control panel, touch the Setup  button.
2. Touch the **Fax Setup** menu.
3. Touch the **Basic Setup** menu.
4. Touch the **Distinctive Ring** button, and then touch the name of an option.

## Use autoreduction for incoming faxes

If the fit-to-page option is turned on, the product automatically reduces long faxes up to 75% to fit the information on the default paper size (for example, the fax is reduced from legal to letter size).

If the fit-to-page option is turned off, long faxes print at full size on multiple pages. The factory-set default for incoming fax autoreduction is **On**.

If you have the **Stamp Faxes** option turned on, you might also want to turn on autoreduction. This reduces the size of the incoming faxes slightly, and prevents the page-stamp from forcing a fax onto two pages.

---

 **NOTE:** Make sure that the default paper size setting matches the size of the paper in the tray.

---

1. From the Home screen on the product control panel, touch the Setup  button.
2. Touch the **Fax Setup** menu.
3. Touch the **Advanced Setup** menu.
4. Touch the **Fit to Page** button, and then touch the **On** button.

## Set fax reprint settings

1. From the Home screen on the product control panel, touch the Setup  button.
2. Touch the **Fax Setup** menu.
3. Touch the **Advanced Setup** menu.
4. Scroll to and touch the **Allow Fax Reprint** button, and then touch the **On** button.

After this feature is turned on, a **Reprint Faxes** button is available in the **Fax Menu > Receive Options** menu.

## Set the fax sounds volume

Use this setting to control the volume of the fax sounds from the control panel. You can make changes to the following sounds:

- Alarm Volume
- Ring Volume
- Phone Line Volume

## Set the alarm volume, phone-line volume, and ring volume

1. From the Home screen on the product control panel, touch the Setup  button.
2. Touch the [System Setup](#) menu.
3. Touch the [Volume Settings](#) menu.
4. Touch the name of the volume setting that you want to adjust, and then touch one of the options. Repeat this step for each volume setting.

## Set stamp-received faxes

The product prints the sender identification information at the top of each received fax. You can also stamp the incoming fax with your own header information to confirm the date and time that the fax was received. The factory-set default for stamp-received faxes is [Off](#).

---

 **NOTE:** Turning on the stamp-received setting might increase the page size and cause the product to print a second page.

 **NOTE:** This option applies only to received faxes that the product prints.

---

1. From the Home screen on the product control panel, touch the Setup  button.
2. Touch the [Fax Setup](#) menu.
3. Touch the [Advanced Setup](#) menu.
4. Scroll to and touch the [Stamp Faxes](#) button, and then touch the [On](#) button.

## Set the private receive feature

When the private-receive feature is active, received faxes are stored in memory and not printed. A password is required to print the stored faxes.

1. From the Home screen on the product control panel, touch the Setup  button.
2. Touch the [Fax Setup](#) menu.
3. Touch the [Advanced Setup](#) menu.

4. Scroll to and touch the [Private Receive](#) button, and then touch the [On](#) button.
5. If you have not already set a system password, the product prompts you to create one.



---

**NOTE:** The system password is case-sensitive.

---

- a. Touch the [OK](#) button, and then use the keypad to enter the system password.
- b. Touch the [OK](#) button, confirm the password by entering it a second time, and then touch the [OK](#) button to save the password.

After this feature is turned on, a [Print Private Faxes](#) button is available in the [Fax Menu > Receive Options](#) menu.

## Set fax polling

If someone else has set up a fax to be polled, you can request that the fax be sent to your product. (This is known as polling another machine).

1. From the Home screen on the product control panel, touch the [Fax](#) button.
2. Touch the [Fax Menu](#) button.
3. Touch the [Receive Options](#) button.
4. Touch the [Polling Receive](#) button.
5. Use the keypad on the touchscreen to enter the number of the fax machine that you want to poll, and then touch the [OK](#) button.

The product dials the other fax machine and requests the fax.

# Use fax

- [Supported fax programs](#)
- [Cancel a fax](#)
- [Delete faxes from memory](#)
- [Use fax on a DSL, PBX, or ISDN system](#)
- [Use fax on a VoIP service](#)
- [Fax memory contents are retained when there is a loss of power](#)
- [Security issues when connecting internal networks to public phone lines](#)
- [Fax from the flatbed scanner](#)
- [Fax from the document feeder](#)
- [Use speed dials and group-dial entries](#)
- [Send a fax from the software \(Windows\)](#)
- [Send a fax by dialing from a telephone connected to the fax line](#)
- [Send a fax with confirmation](#)
- [Schedule a fax to be sent later](#)
- [Send a fax combining an electronic and paper document](#)
- [Use access codes, credit cards, or calling cards](#)
- [Print a fax](#)
- [Receive faxes when fax tones are audible on the phone line](#)



## Supported fax programs

The PC fax program that came with the product is the only PC fax program that works with the product. To continue to use a PC fax program previously installed on the computer, use the modem that is already connected to the computer; it will not function through the product modem.

## Cancel a fax

Use these instructions to cancel a single fax that is currently dialing or a fax that is being transmitted or received.

### Cancel the current fax

Press the Cancel  button on the control panel. Any pages that have not been transmitted are canceled. Pressing the Cancel  button also stops group-dial jobs.

## Cancel a pending fax job

Use this procedure to cancel a fax job in the following situations:

- The product is waiting to redial after encountering a busy signal, an unanswered call, or a communication error.
- The fax is scheduled to be sent at a future time.

Use the following steps to cancel a fax job by using the [Fax Job Status](#) menu:

1. From the Home screen on the product control panel, touch the [Fax](#) button.
2. Touch the [Fax Menu](#) button.
3. Touch the [Send Options](#) button.
4. Touch the [Fax Job Status](#) button.
5. Touch the fax number for the job that you want to cancel.

## Delete faxes from memory

Use this procedure only if you are concerned that someone else has access to your product and might try to reprint faxes from the memory.

**CAUTION:** In addition to clearing the reprint memory, this procedure clears any fax that is currently being sent, unsent faxes that are pending redial, faxes that are scheduled to be sent at a future time, and faxes that are not printed or forwarded.

1. From the Home screen on the product control panel, touch the [Setup](#)  button.
2. Touch the [Service](#) menu.
3. Touch the [Fax Service](#) menu.
4. Touch the [Clear Saved Faxes](#) button.

## Use fax on a DSL, PBX, or ISDN system

HP products are designed specifically for use with traditional analog phone services. They are not designed to work on DSL, PBX, ISDN lines, or VoIP services, but they work with the proper setup and equipment.

**NOTE:** HP recommends discussing DSL, PBX, ISDN, and VoIP setup options with the service provider.

The HP LaserJet product is an analog device that is not compatible with all digital phone environments (unless a digital-to-analog converter is used). HP does not guarantee that the product will be compatible with digital environments or digital-to-analog converters.

### DSL

A digital subscriber line (DSL) uses digital technology over standard copper telephone wires. This product is not directly compatible with those digital signals. However, if the configuration is specified

during DSL setup, the signal can be separated so that some of the bandwidth is used to transmit an analog signal (for voice and fax) while the remaining bandwidth is used to transmit digital data.

 **NOTE:** Not all faxes are compatible with DSL services. HP does not guarantee that the product will be compatible with all DSL service lines or providers.

---

A typical DSL modem employs a filter to separate the higher frequency DSL modem communication from lower frequency analog phone and fax modem communication. It is often necessary to use a filter with analog phones and analog fax products that are connected to a telephone line used by a DSL modem. The DSL service provider usually provides this filter. Contact the DSL provider for more information or for assistance.

## PBX

The product is an analog device that is not compatible in all digital phone environments. Digital-to-analog filters or converters may be needed for faxing functionality. If faxing issues occur in a PBX environment, it might be necessary to contact the PBX provider for assistance. HP does not guarantee that the product will be compatible with digital environments or digital-to-analog converters.

Contact the PBX provider for more information and for assistance.

## ISDN

The product is an analog device that is not compatible in all digital phone environments. Digital-to-analog filters or converters may be needed for faxing functionality. If faxing issues occur in an ISDN environment, it might be necessary to contact the ISDN provider for assistance. HP does not guarantee that the product will be compatible with ISDN digital environments or digital-to-analog converters.

## Use fax on a VoIP service

Voice over internet protocol (VoIP) services are often not compatible with fax machines unless the provider explicitly states that it supports fax over IP services.

If the product experiences problems getting a fax to work on a VoIP network, verify that all cables and settings are correct. Decreasing the fax-speed setting might allow the product to send a fax over a VoIP network.

If the VoIP provider offers a "Pass through" mode for the connection, that will offer better fax performance on VoIP. Also if the provider has "comfort noise" added to the line, fax performance can be enhanced if this feature is not enabled.

If faxing problems continue, contact the VoIP provider.

## Fax memory contents are retained when there is a loss of power

The flash memory protects against data loss when a power failure occurs. Other fax devices store fax pages in either normal RAM or short-term RAM. Normal RAM immediately loses data when power is lost, while short-term RAM loses data about 60 minutes after a power failure occurs. Flash memory can maintain its data for years without power applied.



## Security issues when connecting internal networks to public phone lines

The product can send and receive fax data over telephone lines that conform to public switch telephone network (PSTN) standards. The secure fax protocols make it impossible for computer viruses to be transferred from the telephone line to a computer or network.

The following product features prevent virus transmission:

- No direct connection exists between the fax line and any devices that are connected to the USB or Ethernet ports.
- The internal firmware cannot be modified through the fax connection.
- All fax communications go through the fax subsystem, which does not use Internet data-exchange protocols.

## Fax from the flatbed scanner

1. Place the document face-down on the scanner glass.

**NOTE:** If documents are in the document feeder and on the scanner glass at the same time, the product processes the document in the document feeder and not the one on the scanner glass.



2. From the Home screen on the product control panel, touch the **Fax** button.
3. Use the keypad to enter the fax number.
4. Touch the **Start Fax** button.
5. The product prompts you to confirm that you are sending from the scanner glass. Touch the **Yes** button.
6. The product prompts you to load the first page. Touch the **OK** button.

7. The product scans the first page and then prompts you to load another page. If the document has multiple pages, touch the **Yes** button. Continue this process until you have scanned all the pages.
8. When you have scanned the last page, touch the **No** button at the prompt. The product sends the fax.

## Fax from the document feeder

1. Insert the originals into the document feeder face-up.

**NOTE:** The document feeder capacity is up to 50 sheets of 75 g/m<sup>2</sup> (20 lb) paper.

**CAUTION:** To prevent damage to the product, do not use an original that contains correction tape, correction fluid, paper clips, or staples. Also, do not load photographs, small originals, or fragile originals into the document feeder.

**NOTE:** If documents are in the document feeder and on the scanner glass at the same time, the product processes the document in the document feeder and not the one on the scanner glass.

2. Adjust the paper guides until they are snug against the paper.

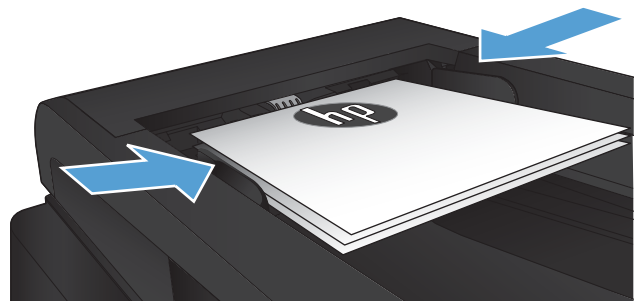
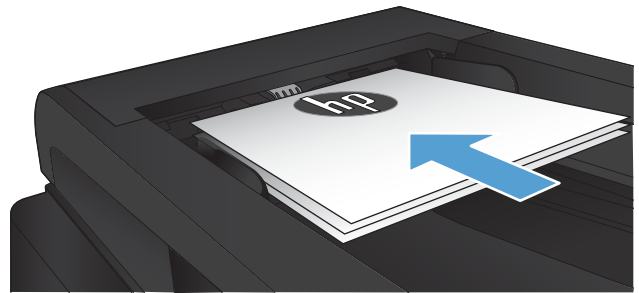

3. From the Home screen on the product control panel, touch the **Fax** button.
4. Use the keypad to enter the fax number.
5. Touch the **Start Fax** button.

## Use speed dials and group-dial entries

1. Load the document onto the scanner glass or into the document feeder.

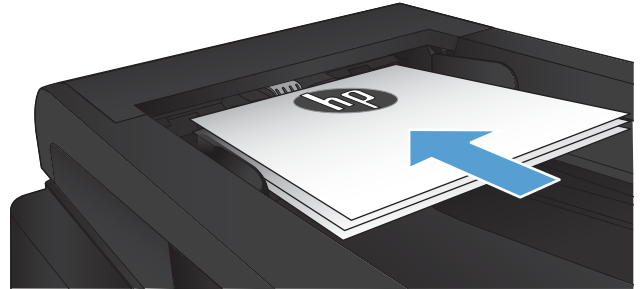

2. From the Home screen on the product control panel, touch the **Fax** button.
3. On the keypad, touch the fax phone book icon.



4. Touch the name of the individual or group entry that you want to use.
5. Touch the **Start Fax** button.

## Send a fax from the software (Windows)

The following information provides basic instructions for sending faxes by using the software that came with the product. All other software-related topics are covered in the software Help, which can be opened from the software-program **Help** menu.

You can fax electronic documents from a computer if you meet the following requirements:

- The product is connected directly to the computer or to a network to which the computer is connected.
- The product software is installed on the computer.
- The computer operating system is one that this product supports.

### Send a fax from the software

The procedure to send a fax varies according to your specifications. The most typical steps follow.

1. Click **Start**, click **Programs** (or **All Programs** in Windows XP), and then click **HP**.
2. Click the product name, and then click **HP Send fax**. The fax software opens.

3. Enter the fax number of one or more recipients.
4. Load the document in the document feeder.
5. Click **Send Now**.

### Send a fax from a third-party software program, such as Microsoft Word

1. Open a document in a third-party program.
2. Click the **File** menu, and then click **Print**.
3. Select the fax print driver from the print driver drop-down list. The fax software opens.
4. Enter the fax number of one or more recipients.
5. Include any pages loaded at the product. This step is optional.
6. Click **Send Now**.

### Send a fax by dialing from a telephone connected to the fax line

Occasionally, you might want to dial a fax number from a telephone that is connected to the same line as the product. For example, if you are sending a fax to a person whose device is in the manual receive mode, you can precede the fax with a voice call to let that person know that the fax is coming.



**NOTE:** The telephone must be connected to the product "telephone" port .

1. Load the document into the document feeder.
2. From the Home screen on the product control panel, touch the **Fax** button.
3. Pick up the handset of a telephone that is connected to the same line as the product. Dial the fax number by using the telephone keypad.
4. When the recipient answers, instruct the person to start the fax machine.
5. When you hear the fax tones, touch the **Start Fax** button on the control panel, wait until the control panel displays the **Connecting** message, and then hang up the telephone.

### Send a fax with confirmation

You can set the product so that it prompts you to enter the fax number a second time to confirm that you are sending the fax to the correct number.

1. From the Home screen on the product control panel, touch the **Setup**  button.
2. Touch the **Fax Setup** menu.
3. Touch the **Advanced Setup** menu.
4. Scroll to and touch the **Confirm Fax Number** button, and touch the **On** button.
5. Send the fax.

## Schedule a fax to be sent later

Use the product control panel to schedule a fax to be sent automatically at a future time to one or more people. When this procedure is completed, the product scans the document into memory and then returns to the Ready state.

 **NOTE:** If the product cannot transmit the fax at the scheduled time, that information is indicated on the fax error report (if that option is turned on) or recorded in the fax activity log. The transmittal might not be initiated because the fax-sending call is not answered, or because a busy signal stops the redial attempts.

If a fax has been scheduled to be sent at a future time but it requires updating, send the additional information as another job. All faxes that are scheduled to go to the same fax number at the same time are delivered as individual faxes.

1. Load the document into the document feeder.

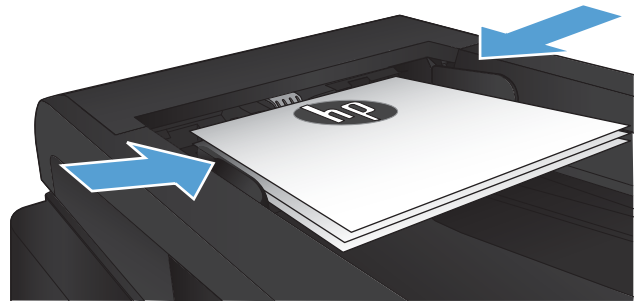

2. From the Home screen on the product control panel, touch the **Fax** button.
3. Touch the **Fax Menu** button.
4. Touch the **Send Options** button.
5. Touch the **Send Fax Later** button.
6. Use the keypad to enter the time of day to send the fax. Touch the **OK** button.
7. Use the keypad to enter the date to send the fax. Touch the **OK** button.
8. Use the keypad to enter the fax number. Touch the **OK** button. The product scans the document and saves it in memory until the designated time.

## Send a fax combining an electronic and paper document

Use the HP Send Fax software to set up this feature. To start the software program, from the Windows **Start** menu, navigate to the program group for this product, and then click the **HP Send Fax** item. Use the software to combine the documents into a single fax job.

## **Use access codes, credit cards, or calling cards**

To use access codes, credit cards, or calling cards, dial manually to allow for pauses and dialing codes.

## **Send faxes internationally**

To send a fax to an international destination, dial manually to allow for pauses and international dialing codes.

## Print a fax

When the product receives a fax transmission, it prints the fax (unless the private-receive feature is enabled) and also stores it automatically to flash memory.

## Reprint a fax

When the [Allow Fax Reprint](#) feature is on, the product stores received faxes in memory. The product has about 3.2 MB of storage space, which holds about 250 pages.

These faxes are stored continuously. Reprinting them does not clear them from the memory.

The default setting for this feature is [Off](#).

### Turn on the Allow Fax Reprint feature

1. From the Home screen on the product control panel, touch the Setup  button.
2. Touch the [Fax Setup](#) menu.
3. Touch the [Advanced Setup](#) menu.
4. Scroll to and touch the [Allow Fax Reprint](#) button, and touch the [On](#) button.

### Reprint faxes

1. From the Home screen on the product control panel, touch the [Fax](#) button.
2. Touch the [Fax Menu](#) button.
3. Touch the [Receive Options](#) button.
4. Touch the [Reprint Faxes](#) button.



## Automatically print on both sides of received faxes

Use the product control panel to configure the product to print two-sided copies of received faxes.

1. From the Home screen on the product control panel, touch the Setup  button.
2. Touch the [Fax Setup](#) button.
3. Touch the [Advanced Setup](#) button.
4. Touch the [Print Duplex](#) button.
5. Touch the [On](#) button.

## Print a stored fax when the private receive feature is on

To use this feature, you must enable the [Private Receive](#) feature on the product. Use the following procedure to enable this feature.

1. From the Home screen on the product control panel, touch the Setup  button.
2. Touch the [Fax Setup](#) button.
3. Touch the [Advanced Setup](#) button.
4. Scroll to and touch the [Private Receive](#) button.
5. Touch the [On](#) button.

To print stored faxes, you must provide the product security password. After the product prints the stored faxes, the faxes are deleted from memory.

1. From the Home screen on the product control panel, touch the [Fax](#) button.
2. Touch the [Fax Menu](#) button.
3. Touch the [Receive Options](#) button.
4. Touch the [Print Private Faxes](#) button.
5. Use the keypad on the touchscreen to enter the product security password, and then touch the [OK](#) button.

## Receive faxes when fax tones are audible on the phone line

If you have a telephone line that receives both fax and telephone calls, and you hear fax tones when you answer the telephone, you can start the receiving process in one of two ways:

- Touch the [Start Fax](#) button on the product control panel.
- Press 1-2-3 in sequence on the telephone keypad, listen for fax transmission sounds, and then hang up.



**NOTE:** For the second method to work, the [Extension Phone](#) option must be turned on. This option is one of the [Advanced Setup](#) options in the [Fax Setup](#) menu.



---

# 8 Manage and maintain

- [Use the HP Reconfiguration Utility to change the product connection \(Windows\)](#)
- [Set up HP Wireless Direct Printing](#)
- [Use HP Web Services applications](#)
- [Configure IP network settings](#)
- [HP Device Toolbox \(Windows\)](#)
- [HP Utility for Mac OS X](#)
- [Use HP Web Jetadmin software](#)
- [Economy settings](#)
- [Product security features](#)
- [Upgrade the firmware](#)

## Use the HP Reconfiguration Utility to change the product connection (Windows)

If you are already using the product and you wish to change the way it is connected, use the HP Reconfiguration Utility to set up the connection. For example, you can reconfigure the product to use a different wireless address, to connect to a wired or wireless network, or change from a network connection to a USB connection. You can change the configuration without inserting the product CD. After you select the type of connection you wish to make, the program goes directly to the portion of the product setup procedure that needs to change.

The HP Reconfiguration Utility is located in the HP programs group on your computer.

# Set up HP Wireless Direct Printing

---

 **NOTE:** This feature is available with wireless models only.

---

The HP Wireless Direct Printing feature lets you print from your wireless mobile device directly to an HP Wireless Direct-enabled product without requiring connection to an established network or the Internet. Use HP Wireless Direct to print wirelessly from the following devices:

- iPhone, iPad, or iPod using Apple AirPrint
- Mobile devices that run Android, iOS, or Symbian using the HP ePrint Home & Biz application

To set up HP Wireless Direct from the control panel, complete the following steps:

---

 **NOTE:** This feature requires you to set up a security password for the product. If you have not previously configured a password, you are prompted to configure one after you enable the feature.

---

1. From the Home screen on the product control panel, touch the Wireless  button.
2. Open the following menus:
  - [Wireless Menu](#)
  - [Wireless Direct Settings](#)
  - [On/Off](#)

---

 **NOTE:** If the [Wireless Direct Settings](#) item does not appear on the control panel, you need to upgrade the product firmware. To get the current version, go to [www.hp.com](http://www.hp.com), enter the HP product number in the search box, select the specific product model, and then click the **Software & Driver Downloads** link.

---

3. Touch the [On](#) menu item. The product might prompt you to set a security password. The product saves the setting and then returns the control panel to the [Wireless Direct Settings](#) menu.

## Use HP Web Services applications

1. From the Home screen on the product control panel, touch the Web Services  button.
2. Touch the [Enable Web Services](#) button.

After you download an application from the HP ePrintCenter Web site, it is available in the [Apps](#) menu on the product control panel. This process enables both HP Web Services and the [Apps](#) menu.

# Configure IP network settings

- [Printer sharing disclaimer](#)
- [View or change network settings](#)
- [Manually configure IPv4 TCP/IP parameters from the control panel](#)
- [Rename the product on a network](#)
- [Link speed and duplex settings](#)

## Printer sharing disclaimer

HP does not support peer-to-peer networking, as the feature is a function of Microsoft operating systems and not of the HP printer drivers. Go to Microsoft at [www.microsoft.com](http://www.microsoft.com).

## View or change network settings

Use the HP Embedded Web Server to view or change IP configuration settings.

1. From the Home screen on the product control panel, touch the Network  button to find the product IP address.
2. To open the HP Embedded Web Server, enter the IP address into the address line of a Web browser.



**NOTE:** You can also access the HP Embedded Web Server from the HP Device Toolbox for Windows or the HP Utility for Mac OS X.

3. Click the **Networking** tab to obtain network information. You can change settings as needed.

## Manually configure IPv4 TCP/IP parameters from the control panel

Use the control-panel menus to manually set an IPv4 address, subnet mask, and default gateway.

1. From the Home screen on the product control panel, touch the Setup  button.
2. Scroll to and touch the **Network Setup** menu.
3. Touch the **TCP/IP Config** menu, and then touch the **Manual** button.
4. Use the keypad on the touchscreen to enter the IP address, and touch the **OK** button. Touch the **Yes** button to confirm.
5. Use the keypad on the touchscreen to enter the subnet mask, and touch the **OK** button. Touch the **Yes** button to confirm.
6. Use the keypad on the touchscreen to enter the default gateway, and touch the **OK** button. Touch the **Yes** button to confirm.

## Rename the product on a network

If you want to rename the product on a network so that it can be uniquely identified, use the HP Embedded Web Server.

1. From the Home screen on the product control panel, touch the Network  button to find the product IP address.
2. To open the HP Embedded Web Server, enter the product IP address into the address line of a Web browser.

---

 **NOTE:** You can also access the HP Embedded Web Server from the HP Device Toolbox for Windows or the HP Utility for Mac OS X.

---

3. Open the **System** tab.
4. On the **Device Information** page, the default product name is in the **Device Status** field. You can change this name to uniquely identify this product.

---

 **NOTE:** Completing the other fields on this page is optional.

---

5. Click the **Apply** button to save the changes.





## Link speed and duplex settings

 **NOTE:** This information applies only to Ethernet networks. It does not apply to wireless networks.

The link speed and communication mode of the print server must match the network hub. For most situations, leave the product in automatic mode. Incorrect changes to the link speed and duplex settings might prevent the product from communicating with other network devices. If you need to make changes, use the product control panel.

 **NOTE:** The setting must match with the network product to which you are connecting (a network hub, switch, gateway, router, or computer).

 **NOTE:** Making changes to these settings causes the product to turn off and then on. Make changes only when the product is idle.

1. From the Home screen on the product control panel, touch the Setup  button.
2. Scroll to and touch the [Network Setup](#) menu.
3. Touch the [Link Speed](#) menu.
4. Select one of the following options.

Setting	Description
<a href="#">Automatic</a>	The print server automatically configures itself for the highest link speed and communication mode allowed on the network.
<a href="#">10T Full</a>	10 Mbps, full-duplex operation
<a href="#">10T Half</a>	10 megabytes per second (Mbps), half-duplex operation
<a href="#">100TX Full</a>	100 Mbps, full-duplex operation
<a href="#">100TX Half</a>	100 Mbps, half-duplex operation
<a href="#">1000T Full</a>	1000 Mbps, full-duplex operation

5. Touch the [OK](#) button. The product turns off and then on.

# HP Device Toolbox (Windows)

Use the HP Device Toolbox for Windows to check product status or to view or change product settings from your computer. This tool opens the HP Embedded Web Server for the product.



**NOTE:** This tool is available only if you performed a full installation when you installed the product. Depending on how the product is connected, some features might not be available.

1. Click the **Start** button, and then click the **Programs** item.
2. Click your HP product group, and then click the **HP Device Toolbox** item.

Tab or section	Description
<b>Home</b> tab Provides product, status, and configuration information.	<ul style="list-style-type: none"><li>• <b>Device Status:</b> Shows the product status and shows the approximate percent life remaining of HP supplies.</li><li>• <b>Supplies Status:</b> Shows the approximate percent life remaining of HP supplies. Actual supply life remaining can vary. Consider having a replacement supply available to install when print quality is no longer acceptable. The supply does not need to be replaced unless the print quality is no longer acceptable.</li><li>• <b>Device Configuration:</b> Shows the information found on the product configuration page.</li><li>• <b>Network Summary:</b> Shows the information found on the product network configuration page.</li><li>• <b>Reports:</b> Print the configuration and supplies status pages that the product generates.</li><li>• <b>Event Log:</b> Shows a list of all product events and errors.</li></ul>
<b>System</b> tab Provides the ability to configure the product from your computer.	<ul style="list-style-type: none"><li>• <b>Device Information:</b> Provides basic product and company information.</li><li>• <b>Paper Setup:</b> Change the default paper-handling settings for the product.</li><li>• <b>Print Quality:</b> Change the default print-quality settings for the product.</li><li>• <b>EcoSMART Console:</b> Change the default times for entering <a href="#">Sleep</a> mode and for <a href="#">Auto Power Down</a> mode. Configure which events cause the product to wake.</li><li>• <b>Paper Types:</b> Configure print modes that correspond to the paper types that the product accepts.</li><li>• <b>System Setup:</b> Change the system defaults for the product.</li><li>• <b>Service:</b> Perform the cleaning procedure on the product.</li><li>• <b>Save and Restore:</b> Save the current settings for the product to a file on the computer. Use this file to load the same settings onto another product or to restore these settings to this product at a later time.</li><li>• <b>Administration:</b> Set or change the product password. Enable or disable product pictures.</li></ul> <p><b>NOTE:</b> The <b>System</b> tab can be password-protected. If this product is on a network, always consult with the administrator before changing settings on this tab.</p>

Tab or section	Description
<p><b>Print</b> tab</p> <p>Provides the ability to change default print settings from your computer.</p>	<ul style="list-style-type: none"> <li>• <b>Printing:</b> Change the default product print settings, such as number of copies and paper orientation. These are the same options that are available on the control panel.</li> <li>• <b>PCL5c:</b> View and change the PCL5c settings.</li> <li>• <b>PostScript:</b> Turn off or on the <b>Print PS Errors</b> feature.</li> </ul>
<p><b>Fax</b> tab</p>	<ul style="list-style-type: none"> <li>• <b>Receive Options:</b> Configure how the product handles incoming faxes.</li> <li>• <b>Phone Book:</b> Add or delete entries in the fax phone book.</li> <li>• <b>Junk Fax List:</b> Set fax numbers to block from sending faxes to the product.</li> <li>• <b>Fax Activity Log:</b> Review recent fax activity for the product.</li> </ul>
<p><b>Scan</b> tab</p>	<p>Configure the <a href="#">Scan to Network Folder</a> and <a href="#">Scan to E-mail</a> features.</p> <ul style="list-style-type: none"> <li>• <b>Network Folder Setup:</b> Configure folders on the network to which the product can save a scanned file.</li> <li>• <b>Scan to E-mail Setup:</b> Begin the process to set up the <a href="#">Scan to E-mail</a> feature.</li> <li>• <b>Outgoing E-mail Profiles:</b> Set an email address that will appear as the “from” address for all emails sent from the product. Configure the SMTP Server information.</li> <li>• <b>E-mail Address Book:</b> Add or delete entries in the email address book.</li> <li>• <b>E-mail Options:</b> Configure a default subject line and body text. Configure default scan settings for emails.</li> </ul>
<p><b>Networking</b> tab</p> <p>Provides the ability to change network settings from your computer.</p>	<p>Network administrators can use this tab to control network-related settings for the product when it is connected to an IP-based network. It also allows the network administrator to set up Wireless Direct functionality. This tab does not appear if the product is directly connected to a computer.</p>
<p><b>HP Web Services</b> tab</p>	<p>Use this tab to set up and use various Web tools with the product.</p>

# HP Utility for Mac OS X

Use the HP Utility for Mac OS X to view or change product settings from your computer.

You can use the HP Utility when the product is connected with a USB cable or is connected to a TCP/IP-based network.

## Open HP Utility

From the Finder, double-click **Applications**, double-click **Hewlett-Packard**, and then click **HP Utility**.

If HP Utility is not included in the **Utilities** list, use the following procedure to open it:

1. At the computer, open the Apple  menu, click the **System Preferences** menu, and then click the **Print & Fax** icon or the **Print & Scan** icon.
2. Select the product in the left side of the window.
3. Click the **Options & Supplies** button.
4. Click the **Utility** tab.
5. Click the **Open Printer Utility** button.

## HP Utility features

Use the HP Utility software to perform the following tasks:

- Obtain information about supplies status.
- Obtain information about the product, such as the firmware version and the serial number.
- Print a configuration page.
- Configure the paper type and size for the tray.
- Transfer files and fonts from the computer to the product.
- Upgrade the product firmware.
- Change the Bonjour name for the product on the Bonjour network.

## Use HP Web Jetadmin software

HP Web Jetadmin is an award-winning, industry-leading tool for efficiently managing a wide variety of networked HP products, including printers, multifunction products, and digital senders. This single solution allows you to remotely install, monitor, maintain, troubleshoot, and secure your printing and imaging environment — ultimately increasing business productivity by helping you save time, control costs, and protect your investment.

HP Web Jetadmin upgrades are periodically made available to provide support for specific product features. Go to [www.hp.com/go/webjetadmin](http://www.hp.com/go/webjetadmin) and click the **Self Help and Documentation** link to learn more about upgrades.

## Economy settings

- [Print with EconoMode](#)
- [Set the Sleep Delay](#)
- [Set the Auto Power Down delay](#)

### Print with EconoMode

This product has an EconoMode option for printing drafts of documents. Using EconoMode can use less toner. However, using EconoMode can also reduce print quality.

HP does not recommend the full-time use of EconoMode. If EconoMode is used full-time, the toner supply might outlast the mechanical parts in the toner cartridge. If print quality begins to degrade and is no longer acceptable, consider replacing the toner cartridge.

 **NOTE:** If this option is not available in your print driver, you can set it using the HP Embedded Web Server

---

1. From the software program, select the **Print** option.
2. Select the product, and then click the **Properties** or **Preferences** button.
3. Click the **Paper/Quality** tab.
4. Click the **EconoMode** check box.

### Set the Sleep Delay

1. From the Home screen on the product control panel, touch the Setup  button.
2. Open the following menus:
  - [System Setup](#)
  - [Energy Settings](#)
  - [Sleep Delay](#)
3. Select the time for the sleep delay.

 **NOTE:** The default value is [15 Minutes](#).

---

### Set the Auto Power Down delay

1. From the Home screen on the product control panel, touch the Setup  button.
2. Open the following menus:
  - [System Setup](#)
  - [Energy Settings](#)

- [Auto Power Down](#)
  - [Power Down Delay](#)
3. Select the time for the power-down delay.



---

**NOTE:** The default value is [30 Minutes](#).

---

4. The product automatically wakes from the auto power-down mode when it receives jobs or when you touch the screen on the product control panel. You can change which events cause the product to wake. Open the following menus:
- [System Setup](#)
  - [Energy Settings](#)
  - [Auto Power Down](#)
  - [Wake Events](#)

To turn off a wake event, select the event and then select the [No](#) option.

## Product security features

The product supports security standards and recommended protocols that help you keep the product secure, protect critical information on your network, and simplify the way you monitor and maintain the product.

For in-depth information about HP's secure imaging and printing solutions, visit [www.hp.com/go/secureprinting](http://www.hp.com/go/secureprinting). The site provides links to white papers and FAQ documents about security features.

### Lock the product

1. You can attach a security cable to the slot on the back of the product.

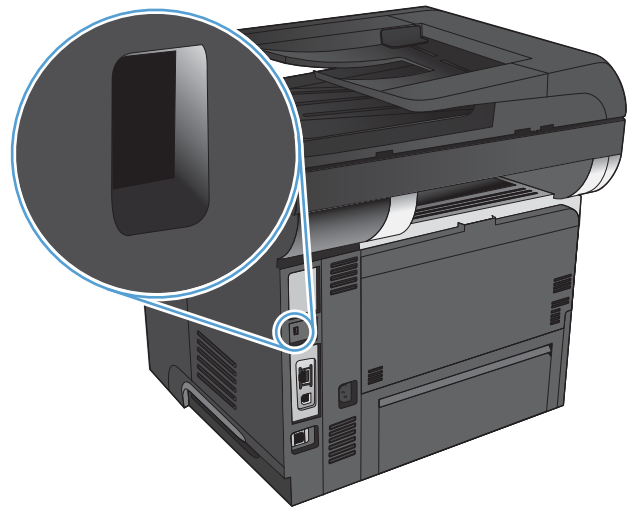

### Set or change the product password

Use the HP Embedded Web Server to set a password or change an existing password for a product on a network.

1. From the Home screen on the product control panel, touch the Network  button to find the product IP address.
2. To open the HP Embedded Web Server, enter the product IP address into the address line of a Web browser.

---

 **NOTE:** You can also access the HP Embedded Web Server from the HP Device Toolbox for Windows or the HP Utility for Mac OS X.

---

3. Click the **System** tab, and click the **Administration** link.

---

 **NOTE:** If a password has previously been set, you are prompted to provide the password. Enter the password, and then click the **OK** button.

---

4. Enter the new password in the **Password** box and in the **Confirm password** box.
5. At the bottom of the window, click the **Apply** button to save the password.



# Upgrade the firmware

HP offers periodic upgrades to the product firmware. You can load the firmware upgrades manually, or you can set the product to automatically load firmware upgrades.

## Manually upgrade the firmware

1. From the Home screen on the product control panel, touch the Setup  button.
2. Open the following menus:
  - Service
  - LaserJet Update
  - Check For Updates Now
3. Touch the Yes button to prompt the product to search for firmware upgrades. If the product detects an upgrade, it will begin the upgrade process.

## Set the product to automatically upgrade the firmware

1. From the Home screen on the product control panel, touch the Setup  button.
2. Open the following menus:
  - Service
  - LaserJet Update
  - Manage Updates
  - Prompt Before Install
3. Touch the Install automatically option.



---

# 9 Solve problems

- [Solve problems checklist](#)
- [Restore the factory-set defaults](#)
- [Control panel help system](#)
- [Paper feeds incorrectly or becomes jammed](#)
- [Clear jams](#)
- [Improve print quality](#)
- [Improve copy quality](#)
- [Improve scan quality](#)
- [Improve fax quality](#)
- [The product does not print or it prints slowly](#)
- [Solve walk-up USB printing problems](#)
- [Solve fax problems](#)
- [Solve USB connection problems](#)
- [Solve wired network problems](#)
- [Solve wireless network problems](#)
- [Solve product software problems with Windows](#)
- [Solve product software problems with Mac OS X](#)
- [Remove software \(Windows\)](#)
- [Remove software \(Mac OS X\)](#)
- [Solve scan to email problems](#)
- [Solve scan to network folder problems](#)

# Solve problems checklist

Follow these steps when trying to solve a problem with the product.

- [Step 1: Make sure that the product is set up correctly](#)
- [Step 2: Check the cabling or wireless connection](#)
- [Step 3: Check the control panel for error messages](#)
- [Step 4: Check the paper](#)
- [Step 5: Check the software](#)
- [Step 6: Test print functionality](#)
- [Step 7: Test copy functionality](#)
- [Step 8: Test the fax functionality](#)
- [Step 9: Check the toner cartridge](#)
- [Step 10: Try sending a print job from a computer](#)
- [Step 11: Verify that the product is on the network](#)

## Step 1: Make sure that the product is set up correctly

1. Press the power button to turn on the product or to deactivate the Auto Power Down mode.
2. Check the power-cable connections.
3. Make sure that the line voltage is correct for the product power configuration. (See the label on the back of the product for voltage requirements.) If you are using a power strip and its voltage is not within specifications, connect the product directly to the wall outlet. If it is already connected to a wall outlet, try a different outlet.
4. If none of these measures restores power, contact HP Customer Care.

## Step 2: Check the cabling or wireless connection

1. Check the cable connection between the product and the computer. Make sure that the connection is secure.
2. Make sure that the cable itself is not faulty by using a different cable, if possible.
3. If the product is connected to a network, check the following items:
  - Check the light next to the network connection on the product. If the network is active, the light is green.
  - Make sure that you are using a network cable and not a phone cord to connect to the network.
  - Make sure the network router, hub, or switch is turned on and that it is working correctly.

- If your computer or the product is connected to a wireless network, low signal quality or interference might be delaying print jobs.
- If the product is connected wirelessly, print a Wireless Network Test Report to verify that the wireless connection is working correctly.
  - a. From the Home screen on the product control panel, touch the Setup  button.
  - b. Touch the [Self Diagnostics](#) button.
  - c. Touch the [Run Wireless Test](#) button to print the report.
- 4. If you are using a personal firewall system on the computer, it might be blocking communication with the product. Try temporarily disabling the firewall to see if it is the source of the problem.

### Step 3: Check the control panel for error messages

The control panel should indicate ready status. If an error message displays, resolve the error.

### Step 4: Check the paper

1. Make sure that the paper that you are using meets specifications.
2. Make sure that the paper is loaded correctly in the input tray.

### Step 5: Check the software

1. Make sure that the product software is installed correctly.
2. Verify that you have installed the print driver for this product. Check the program to make sure that you are using the print driver for this product.

### Step 6: Test print functionality

1. Print a configuration report.
  - a. From the Home screen on the product control panel, touch the Information  button.
  - b. Touch the [Report](#) button to print the configuration report.
2. If the page does not print, verify that the input tray contains paper.
3. If the page jams in the product, clear the jam.

## Step 7: Test copy functionality

1. Place the configuration page into the document feeder and make a copy. If paper does not feed smoothly through the document feeder, you might need to clean the document feeder rollers and separation pad. Make sure the paper meets specifications for this product.
2. Place the configuration page onto the scanner glass and make a copy.
3. If the print quality on the copied pages is not acceptable, clean the scanner glass and the small glass strip.

---

**⚠ CAUTION:** Do not use abrasives, acetone, benzene, ammonia, ethyl alcohol, or carbon tetrachloride on any part of the product; these can damage the product. Do not place liquids directly on the scanner glass. They might seep and damage the product.

---

## Step 8: Test the fax functionality

1. From the Home screen on the product control panel, touch the Setup  button.
2. Open the following menus:
  - Service
  - Fax Service
3. Touch the **Run Fax Test** button to print the Fax Test Report, which provides information about fax functionality.

## Step 9: Check the toner cartridge

Print a supplies status page and check remaining life of the toner cartridge.

1. From the Home screen on the product control panel, touch the Supplies  button.
2. Touch the **Report** button to print the supplies status page.

## Step 10: Try sending a print job from a computer

1. Try printing the job from another computer that has the product software installed.
2. Check the USB or network cable connection. Direct the product to the correct port, or reinstall the software, selecting the connection type that you are using.
3. If the print quality is unacceptable, verify that the print settings are correct for the paper that you are using.

## Step 11: Verify that the product is on the network

For networked products, open a Web browser, and enter the product IP address (from the previously printed configuration page) in the address box to open the HP Embedded Web Server (EWS). If the HP EWS does not open, reinstall the product on the network.

## Restore the factory-set defaults

Restoring the factory-set defaults returns all of the product and network settings to the factory defaults. It will not reset the page count, tray size, or language. To restore the product to the factory-default settings, follow these steps.

---

**⚠ CAUTION:** Restoring the factory-set defaults returns all of the settings to the factory defaults, and it also deletes any pages that are stored in the memory.

---

1. On the product control panel, touch the Setup  button.
2. Scroll to and touch the [Service](#) menu.
3. Scroll to and touch the [Restore Defaults](#) button, and then touch the [OK](#) button.

The product automatically restarts.

## Control panel help system

The product has a built-in Help system that explains how to use each screen. To open the Help system, touch the Help ? button in the upper-right corner of the screen.

For some screens, the Help opens to a global menu where you can search for specific topics. You can browse through the menu structure by touching the buttons in the menu.

Some Help screens include animations that guide you through procedures, such as clearing jams.

For screens that contain settings for individual jobs, the Help opens to a topic that explains the options for that screen.

If the product alerts you of an error or warning, touch the Help ? button to open a message that describes the problem. The message also contains instructions to help solve the problem.



# Paper feeds incorrectly or becomes jammed

- [The product does not pick up paper](#)
- [The product picks up multiple sheets of paper](#)
- [The document feeder jams, skews, or picks up multiple sheets of paper](#)
- [Prevent paper jams from the paper trays](#)

## The product does not pick up paper

If the product does not pick up paper from the tray, try these solutions.

1. Open the product and remove any jammed sheets of paper.
2. Load the tray with the correct size of paper for your job.
3. Make sure the paper size and type are set correctly on the product control panel.
4. Make sure the paper guides in the tray are adjusted correctly for the size of paper. Adjust the guides to the appropriate indentation in the tray.
5. Check the product control panel to see if the product is waiting for you to acknowledge a prompt to feed the paper manually. Load paper, and continue.
6. The rollers above the tray might be contaminated. Clean the rollers with a lint-free cloth dampened with warm water.

## The product picks up multiple sheets of paper

If the product picks up multiple sheets of paper from the tray, try these solutions.

1. Remove the stack of paper from the tray and flex it, rotate it 180 degrees, and flip it over. *Do not fan the paper.* Return the stack of paper to the tray.
2. Use only paper that meets HP specifications for this product.
3. Use paper that is not wrinkled, folded, or damaged. If necessary, use paper from a different package.
4. Make sure the tray is not overfilled. If it is, remove the entire stack of paper from the tray, straighten the stack, and then return some of the paper to the tray.
5. Make sure the paper guides in the tray are adjusted correctly for the size of paper. Adjust the guides to the appropriate indentation in the tray.
6. Make sure the printing environment is within recommended specifications.

## The document feeder jams, skews, or picks up multiple sheets of paper

- The original might have something on it, such as staples or self-adhesive notes, that must be removed.
- Make sure that the document-feeder cover is closed.
- The pages might not be placed correctly. Straighten the pages and adjust the paper guides to center the stack.
- The paper guides must be touching the sides of the paper stack to work correctly. Make sure that the paper stack is straight and the guides are against the paper stack.
- Verify that there are no pieces of paper, staples, paper clips, or other debris in the paper path.
- Clean the document-feeder rollers and the separation pad. Use compressed air or a clean, lint-free cloth moistened with warm water.

## Prevent paper jams from the paper trays

To reduce the number of paper jams, try these solutions.

1. Use only paper that meets HP specifications for this product.
2. Use paper that is not wrinkled, folded, or damaged. If necessary, use paper from a different package.
3. Use paper that has not previously been printed or copied on.
4. Make sure the tray is not overfilled. If it is, remove the entire stack of paper from the tray, straighten the stack, and then return some of the paper to the tray.
5. Make sure the paper guides in the tray are adjusted correctly for the size of paper. Adjust the guides so they are touching the paper stack without bending it.
6. Make sure that the tray is fully inserted in the product.
7. If you are printing on heavy, embossed, or perforated paper, use the manual feed feature and feed sheets one at a time.
8. Verify that the tray is configured correctly for the paper type and size.
9. Make sure the printing environment is within recommended specifications.

# Clear jams

- [Jam locations](#)
- [Clear jams in the document feeder](#)
- [Clear jams in the output area](#)
- [Clear jams in Tray 1](#)
- [Clear jams in Tray 2 or optional Tray 3](#)
- [Clear jams in the fuser](#)
- [Clear jams in the duplexer](#)

## Jam locations

Use this illustration to identify locations of jams. In addition, instructions display on the control panel to direct you to the location of jammed paper and how to clear it.

 **NOTE:** Internal areas of the product that might need to be opened to clear jams have green handles or green labels.

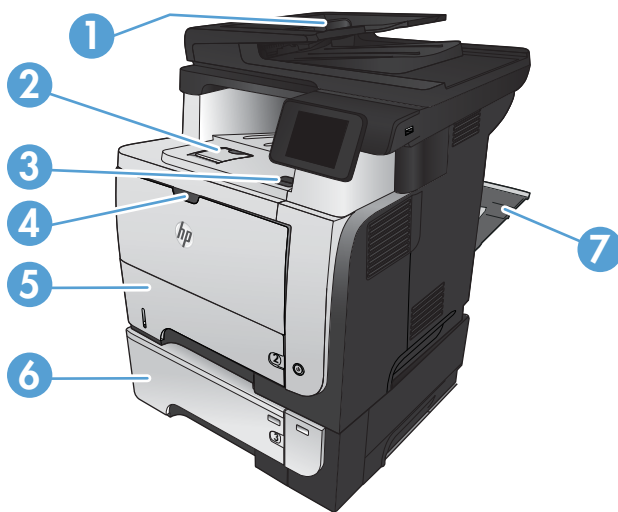

1	Document-feeder area
2	Output-bin area
3	Top-cover and toner-cartridge area
4	Tray 1 area
5	Tray 2 pickup area Duplexing area (remove Tray 2 for access)
6	Optional Tray 3
7	Rear door

## Clear jams in the document feeder

1. Open the document-feeder cover.

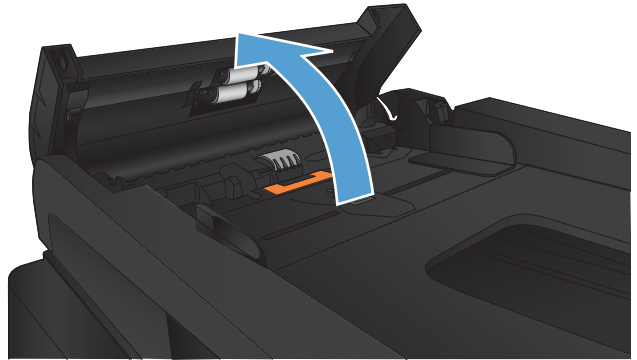

2. Gently pull the jammed paper out.

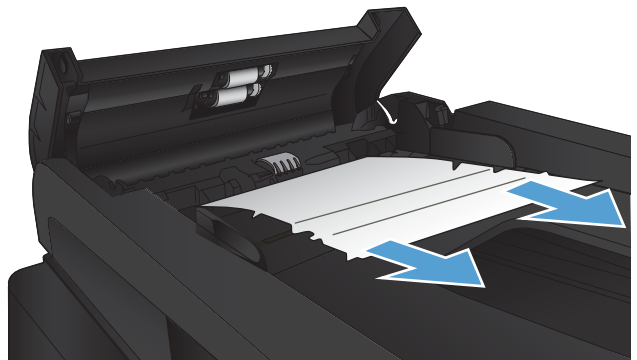

3. Close the document-feeder cover. Make sure it is completely closed.

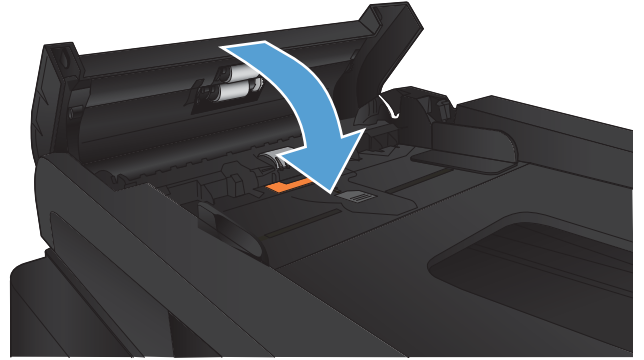

4. Open the scanner lid. If paper is jammed in the scanner lid, gently pull it out.

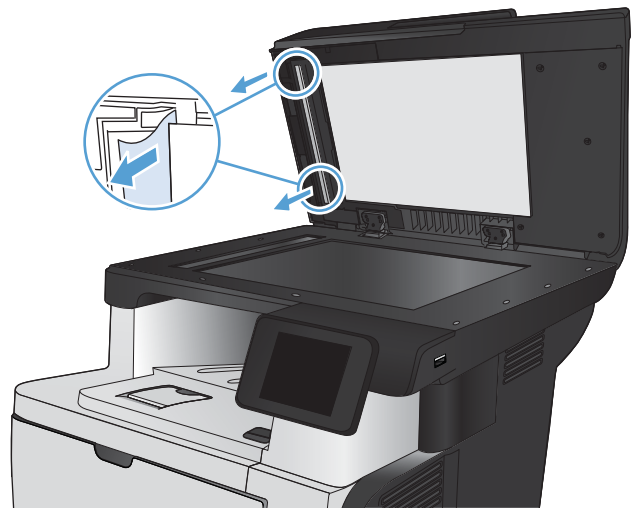

## Clear jams in the output area

1. If paper is visible from the output bin, grasp the leading edge and remove it.



2. Open the rear door, and push down so it is fully opened to a 90° angle.

**NOTE:** The rear door has two positions. It opens to a 45° angle for the rear output bin and to a 90° angle for clearing jams.

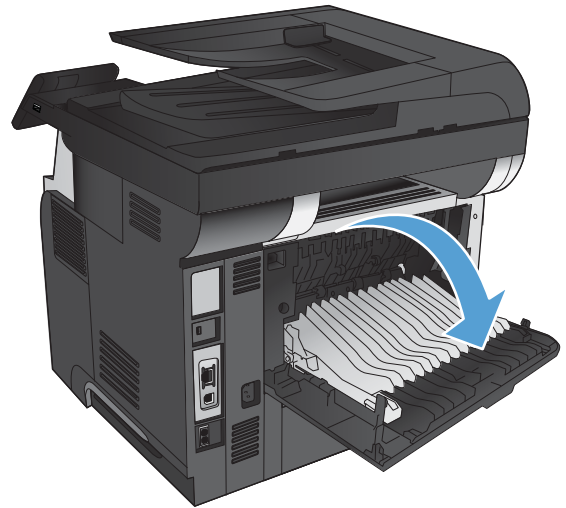

3. Remove any jammed paper.



4. Close the rear door.

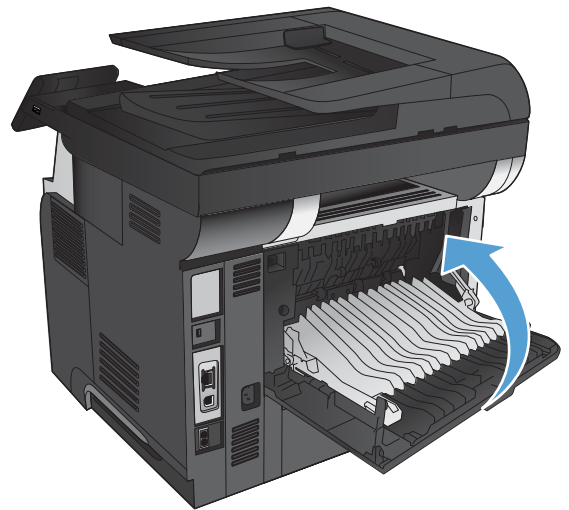

## Clear jams in Tray 1

1. If most of the sheet of paper is visible in the tray, slowly pull the jammed paper out of the product.

If most of the sheet of paper has been pulled inside the product, continue with the following steps.

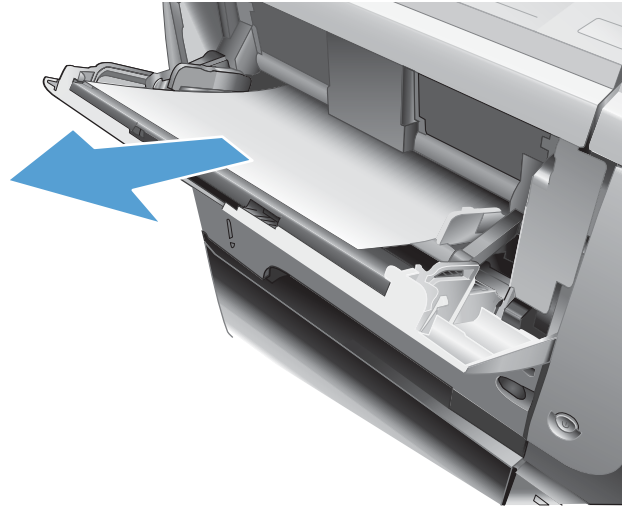

2. Press the front-door-release button.



3. Open the front door.

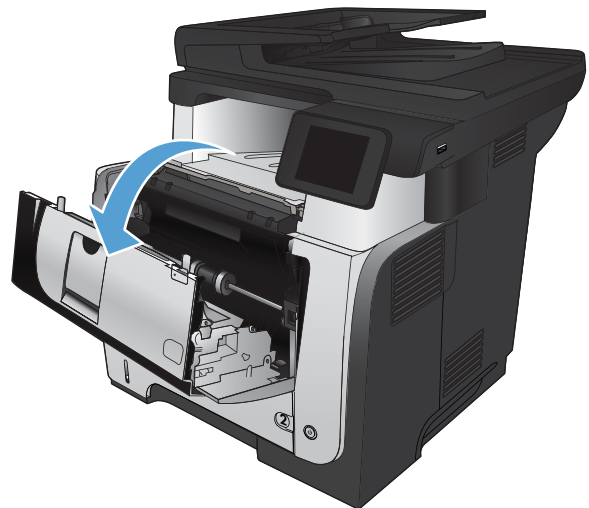



4. Remove the toner cartridge.

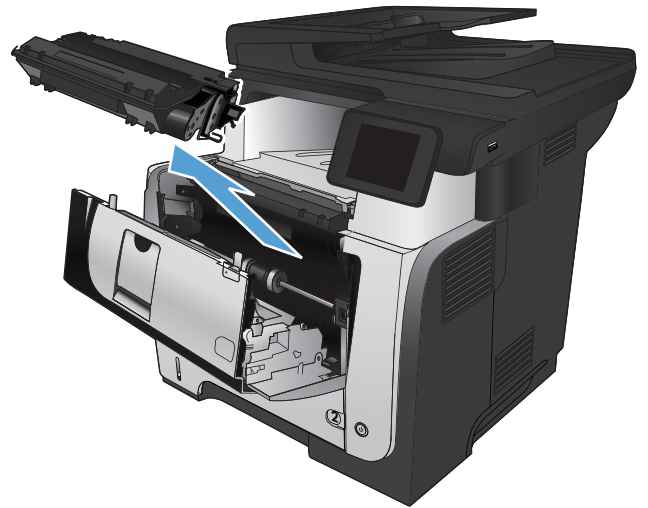

5. Lift the jam-access covers and remove any jammed paper.

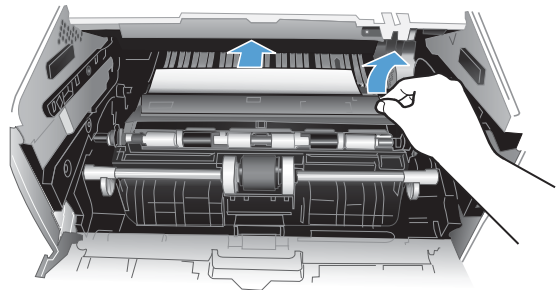

6. Reinsert the toner cartridge.

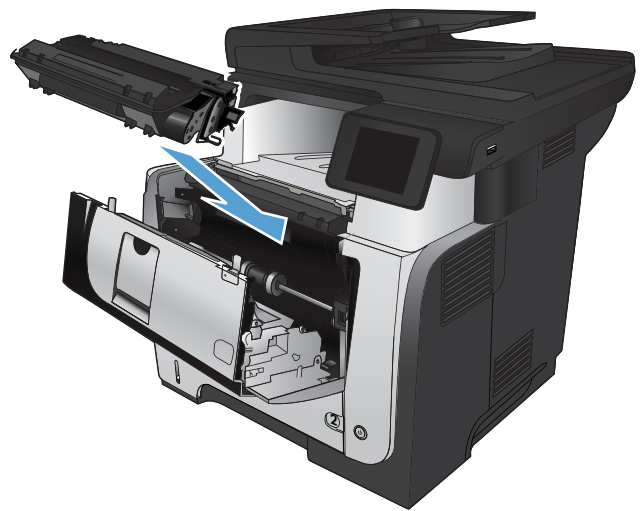

7. Close the front door.

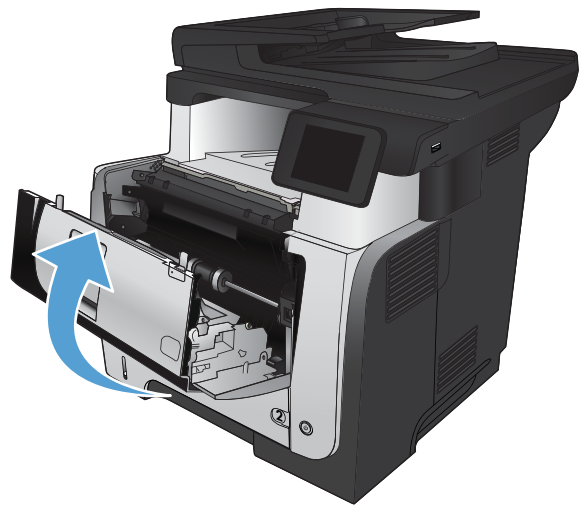

## Clear jams in Tray 2 or optional Tray 3

1. Remove the tray from the product.

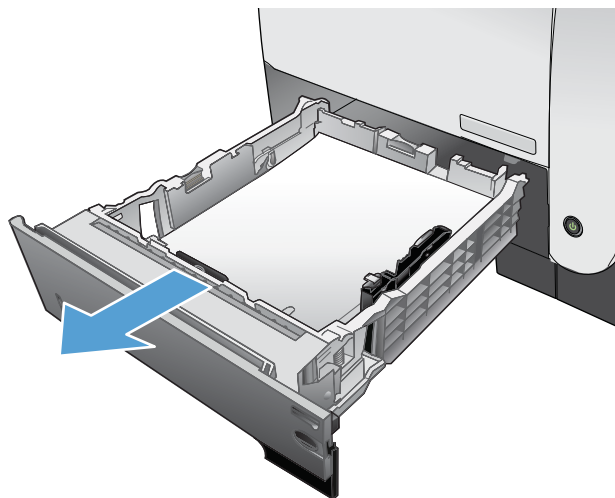

2. Remove the paper from the tray, and discard any damaged paper.

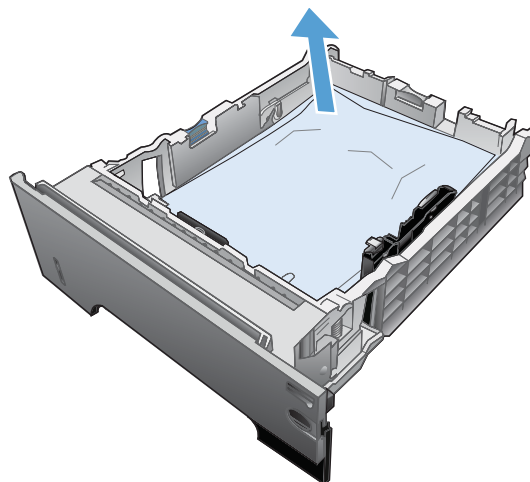

3. Verify that the rear paper guide is adjusted to the indentation for the correct paper size. If necessary, pinch the release and move the rear paper guide to the correct position. It should click into place.

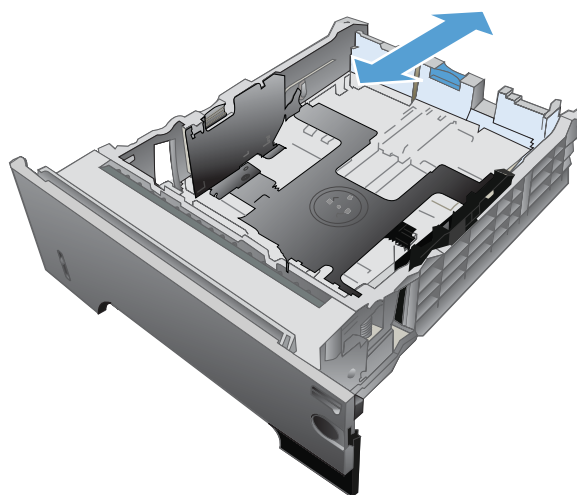

4. Load the paper into the tray. Make sure that the stack is flat at all four corners and that the top of the stack is below the maximum-height indicators.

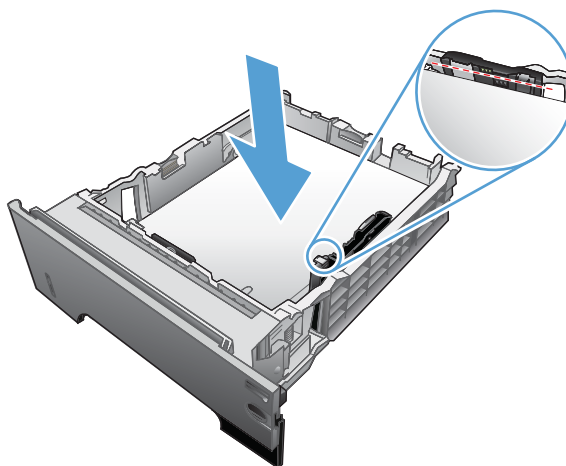

5. Reinsert and close the tray.

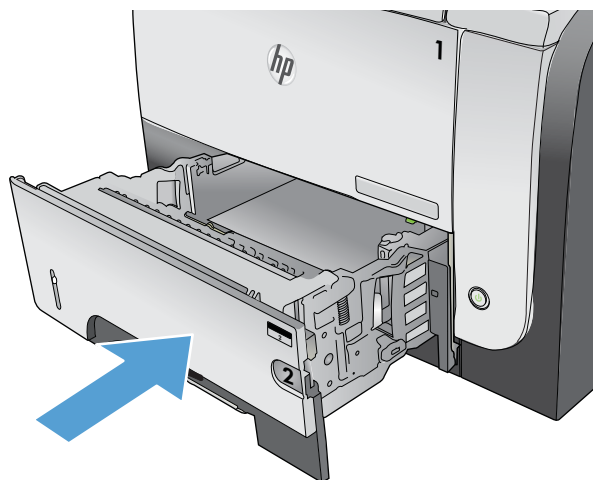

6. Press the front-door-release button.



7. Open the front door.

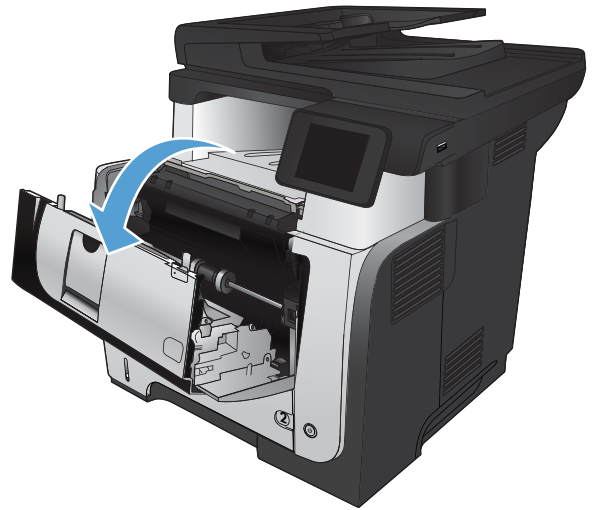

8. Remove the toner cartridge.



9. Lift the jam-access covers and remove any jammed paper.

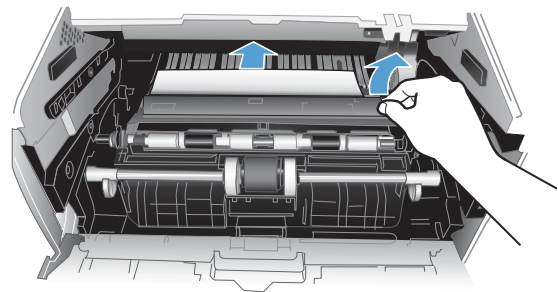

**10.** Reinsert the toner cartridge.

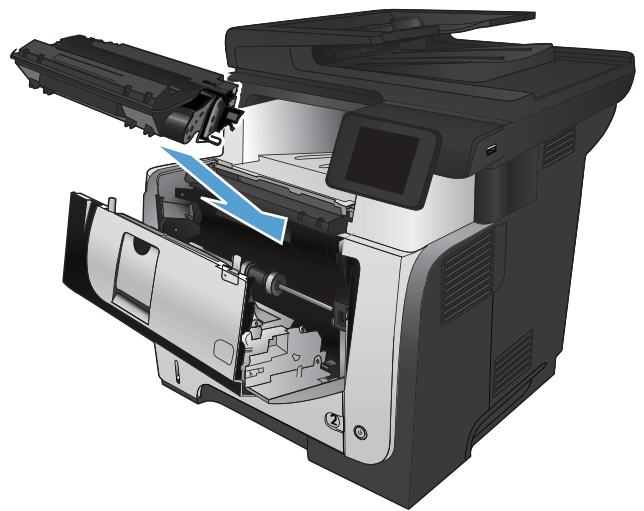

**11.** Close the front door.

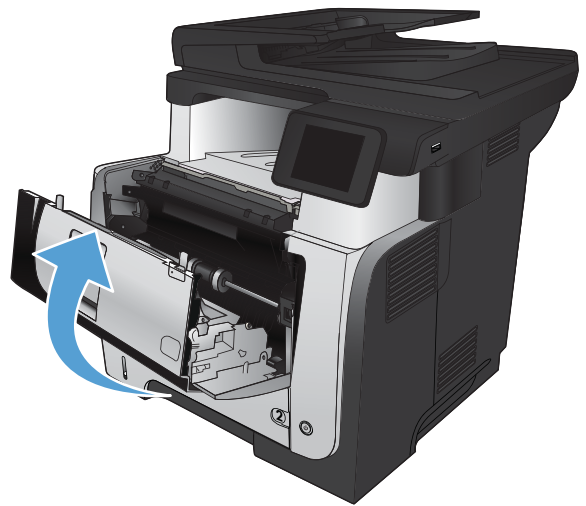

## Clear jams in the fuser

1. Press the front-door-release button.



2. Open the front door.

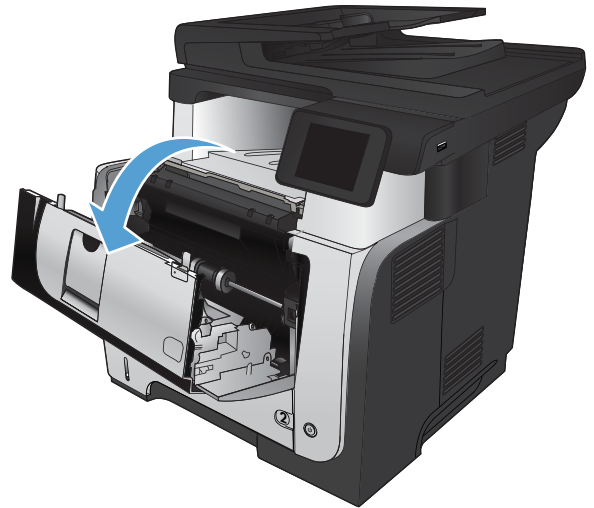

3. Remove the toner cartridge.

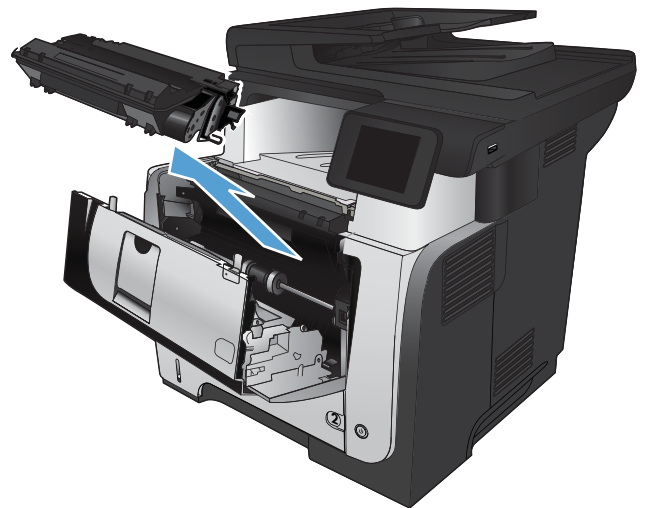

4. Lift the jam-access covers and remove any jammed paper.

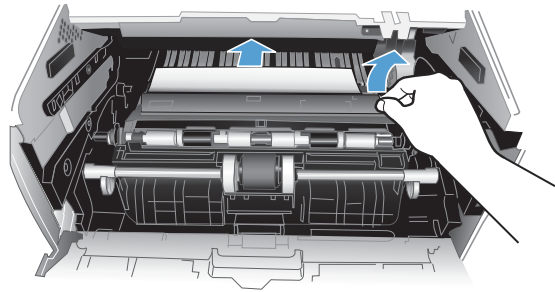

5. Reinsert the toner cartridge.

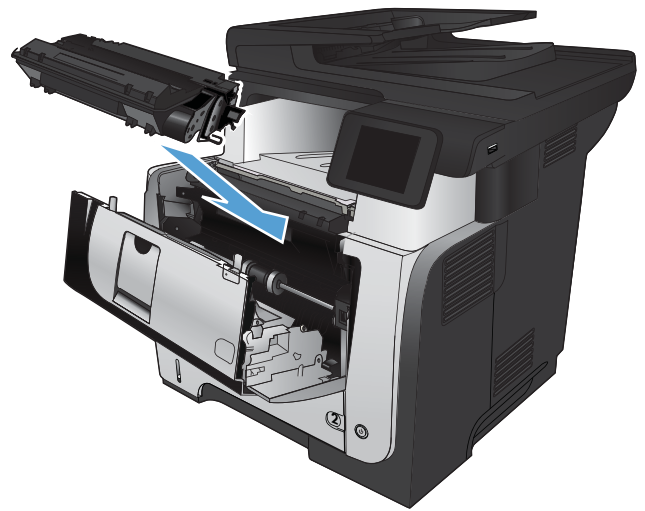

6. Close the front door.

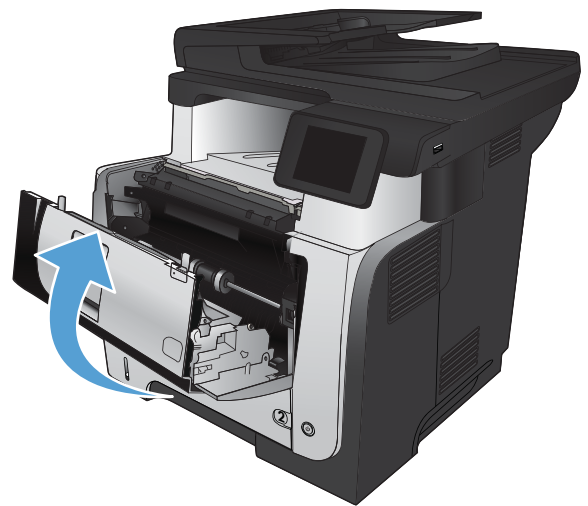



## Clear jams in the duplexer

1. Completely remove Tray 2 from the product.

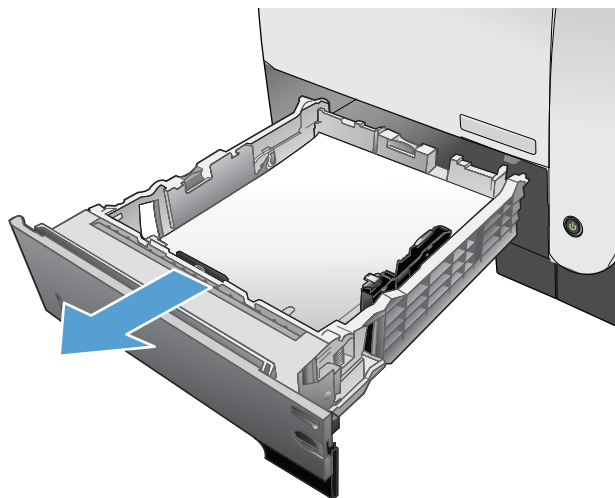

2. Push the green button to release the duplex pan.

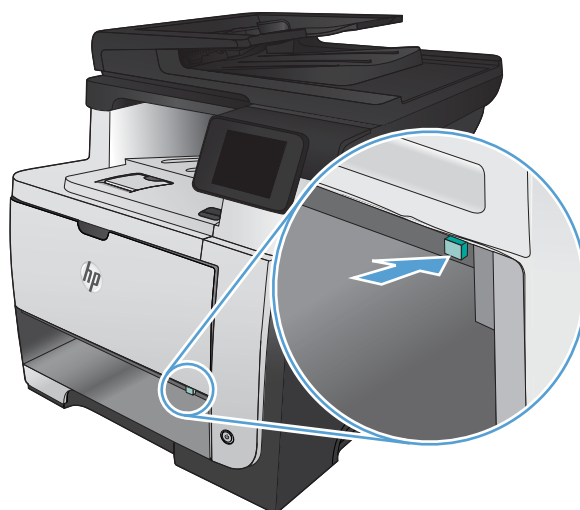

3. Remove any jammed paper.

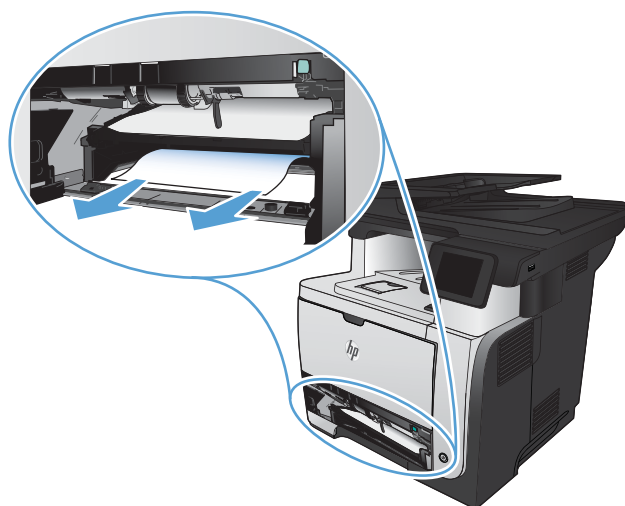

4. Close the duplex pan.

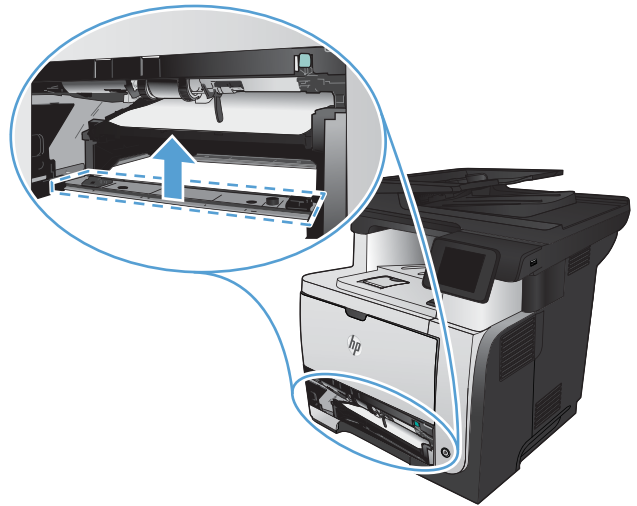

5. Reinsert Tray 2.

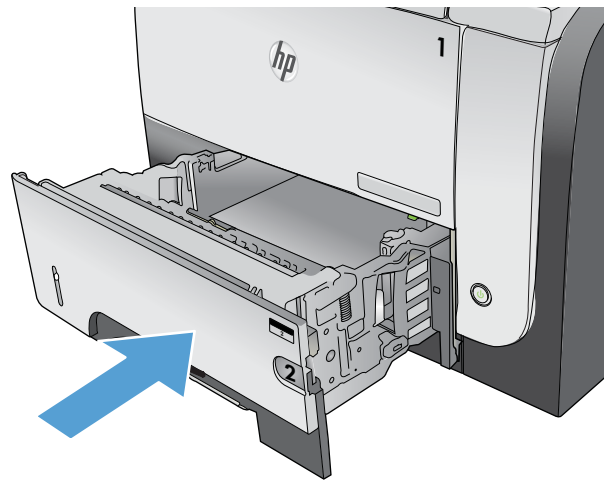

# Improve print quality

- [Print from a different software program](#)
- [Set the paper-type setting for the print job](#)
- [Check the toner-cartridge status](#)
- [Print a cleaning page](#)
- [Visually inspect the toner cartridge](#)
- [Check the paper and printing environment](#)
- [Check the EconoMode settings](#)
- [Try a different print driver](#)

## Print from a different software program

Try printing from a different software program. If the page prints correctly, the problem is with the software program from which you were printing.

## Set the paper-type setting for the print job

Check the paper type-setting if you are printing from a software program and the pages have any of these problems:

- smeared print
- fuzzy print
- dark print
- curled paper
- scattered dots of toner
- loose toner
- small areas of missing toner

## Check the paper-type setting (Windows)

1. From the software program, select the **Print** option.
2. Select the product, and then click the **Properties** or **Preferences** button.
3. Click the **Paper/Quality** tab.
4. From the **Paper type** drop-down list, click the **More...** option.
5. Expand the list of **Type is:** options.
6. Expand the category of paper types that best describes your paper.

7. Select the option for the type of paper you are using, and click the **OK** button.
8. Click the **OK** button to close the **Document Properties** dialog box. In the **Print** dialog box, click the **OK** button to print the job.

## Check the paper-type setting (Mac OS X)

1. Click the **File** menu, and then click the **Print** option.
2. In the **Printer** menu, select the product.
3. By default, the print driver displays the **Copies & Pages** menu. Open the menus drop-down list, and then click the **Finishing** menu.
4. Select a type from the **Media-type** drop-down list.
5. Click the **Print** button.

## Check the toner-cartridge status

Check the supplies status page for the following information:

- Estimated percentage of cartridge life remaining
- Approximate pages remaining
- Part numbers for HP toner cartridges
- Number of pages printed

Use the following procedure to print the supplies status page:

1. From the Home screen on the product control panel, touch the Supplies  button.
2. Touch the **Report** button to print the supplies status page.

## Print a cleaning page

1. From the Home screen on the product control panel, touch the Setup  button.
2. Touch the **Service** menu.
3. Touch the **Cleaning Page** button.
4. Load plain letter or A4 paper when you are prompted.
5. Touch the **OK** button to begin the cleaning process.

The product prints the first side and then prompts you to remove the page from the output bin and reload it in Tray 1, keeping the same orientation. Wait until the process is complete. Discard the page that prints.

## Visually inspect the toner cartridge

1. Remove the toner cartridge from the product, and verify that the sealing tape has been removed.
2. Check the memory chip for damage.
3. Examine the surface of the green imaging drum on the toner cartridge.

---

 **CAUTION:** Do not touch the imaging drum. Fingerprints on the imaging drum can cause print-quality problems.

---

4. If you see any scratches, fingerprints, or other damage on the imaging drum, replace the toner cartridge.
5. If the imaging drum does not appear to be damaged, rock the toner cartridge gently several times and reinstall it. Print a few pages to see if the problem has resolved.

## Check the paper and printing environment

### Use paper that meets HP specifications

Use different paper if you are having any of the following problems:

- The printing is too light or seems faded in areas.
- Specks of toner are on the printed pages.
- Toner is smearing on the printed pages.
- Printed characters seem misformed.
- Printed pages are curled.

Always use a paper type and weight that this product supports. In addition, follow these guidelines when selecting paper:

- Use paper that is of good quality and free of cuts, nicks, tears, spots, loose particles, dust, wrinkles, voids, staples, and curled or bent edges.
- Use paper that has not been previously printed on.
- Use paper that is designed for use in laser printers. Do not use paper that is designed only for use in inkjet printers.
- Use paper that is not too rough. Using smoother paper generally results in better print quality.

### Check the product environment

Verify that the product is operating within the environmental specifications listed in the product Warranty and Legal Guide.

## Check the EconoMode settings

HP does not recommend the full-time use of EconoMode. If EconoMode is used full-time, the toner supply might outlast the mechanical parts in the toner cartridge. If print quality begins to degrade and is no longer acceptable, consider replacing the toner cartridge.

 **NOTE:** This feature is available with the PCL 6 print driver for Windows. If you are not using that driver, you can enable the feature by using the HP Embedded Web Server.

Follow these steps if the entire page is too dark or too light.

1. From the software program, select the **Print** option.
2. Select the product, and then click the **Properties** or **Preferences** button.
3. Click the **Paper/Quality** tab, and locate the **Print Quality** area.
4. If the entire page is too dark, use these settings:
  - Select the **600 dpi** option.
  - Select the **EconoMode** check box to enable it.

If the entire page is too light, use these settings:

- Select the **FastRes 1200** option.
  - Clear the **EconoMode** check box to disable it.
5. Click the **OK** button to close the **Document Properties** dialog box. In the **Print** dialog, click the **OK** button to print the job.

## Try a different print driver

You might need to use a different print driver if the printed page has unexpected lines in graphics, missing text, missing graphics, incorrect formatting, or substituted fonts.

---

### HP PCL 6 driver

- Provided as the default driver. This driver is automatically installed unless you select a different one.
- Recommended for all Windows environments
- Provides the overall best speed, print quality, and product-feature support for most users
- Developed to align with the Windows Graphic Device Interface (GDI) for the best speed in Windows environments
- Might not be fully compatible with third-party and custom software programs that are based on PCL 5

---

### HP UPD PS driver

- Recommended for printing with Adobe® software programs or with other highly graphics-intensive software programs
  - Provides support for printing from postscript emulation needs, or for postscript flash font support
-

**HP UPD PCL 5**

- Recommended for general office printing in Windows environments
- Compatible with previous PCL versions and older HP LaserJet products
- The best choice for printing from third-party or custom software programs
- The best choice when operating with mixed environments, which require the product to be set to PCL 5 (UNIX, Linux, mainframe)
- Designed for use in corporate Windows environments to provide a single driver for use with multiple product models
- Preferred when printing to multiple product models from a mobile Windows computer

---

**HP UPD PCL 6**

- Recommended for printing in all Windows environments
  - Provides the overall best speed, print quality, and product feature support for most users
  - Developed to align with Windows Graphic Device Interface (GDI) for best speed in Windows environments
  - Might not be fully compatible with third-party and custom solutions based on PCL5
- 

Download additional print drivers from this Web site: [www.hp.com/go/ljmfpm521series\\_software](http://www.hp.com/go/ljmfpm521series_software).

# Improve copy quality

- [Check the scanner glass for dirt and smudges](#)
- [Check the paper settings](#)
- [Optimize for text or pictures](#)
- [Edge-to-edge copying](#)
- [Clean the pickup rollers and separation pad in the document feeder](#)

## Check the scanner glass for dirt and smudges

Over time, specks of debris might collect on the scanner glass and white plastic backing, which can affect performance. Use the following procedure to clean the scanner.

1. Press the power button to turn the product off, and then disconnect the power cable from the electrical outlet.

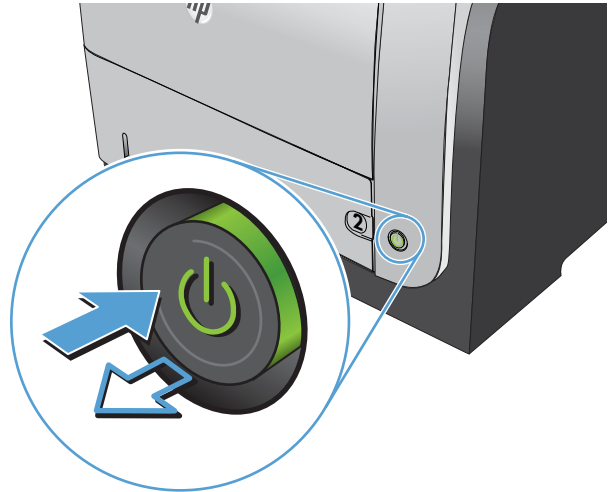

2. Open the scanner lid.
3. Clean the scanner glass, the document feeder strips, and the white plastic backing with a soft cloth or sponge that has been moistened with nonabrasive glass cleaner.

**CAUTION:** Do not use abrasives, acetone, benzene, ammonia, ethyl alcohol, or carbon tetrachloride on any part of the product; these can damage the product. Do not place liquids directly on the glass or platen. They might seep and damage the product.

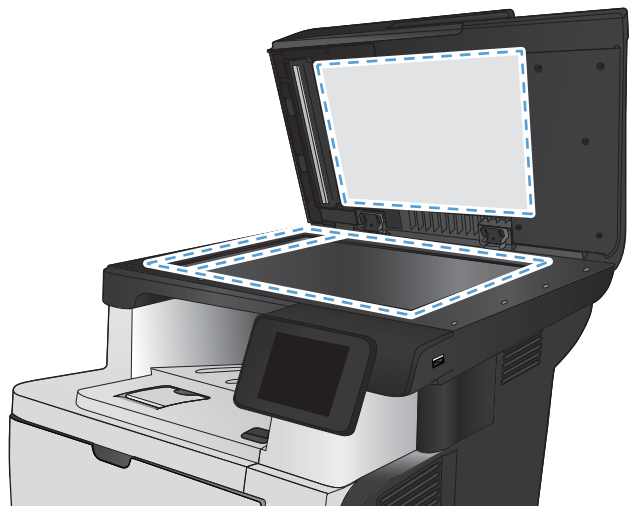



4. Dry the glass and white plastic parts with a chamois or a cellulose sponge to prevent spotting.
5. Connect the power cable to an outlet, and then press the power button to turn the product on.

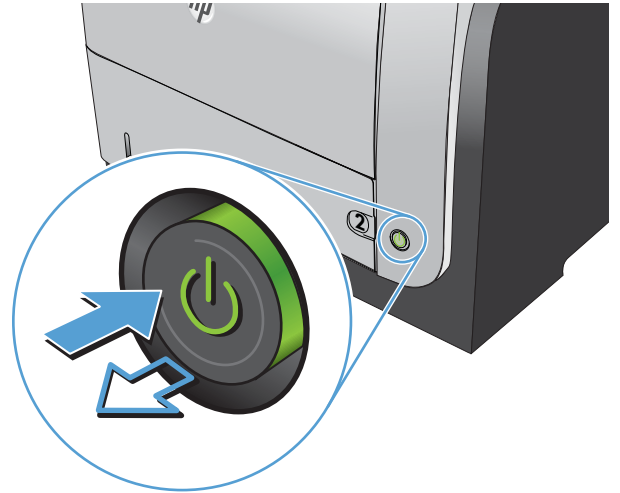

## Check the paper settings

1. From the Home screen on the product control panel, touch the **Copy** button.
2. Touch the **Settings** button, and then scroll to and touch the **Paper** button.
3. From the list of paper sizes, touch the name of the paper size that is in Tray 1.
4. From the list of paper types, touch the name of the paper type that is in Tray 1.
5. Touch the **Start Copy** button to start copying.

## Optimize for text or pictures

The following copy-quality settings are available:

- **Auto Select:** Use this setting when you are not concerned about the quality of the copy. This is the default setting.
- **Mixed:** Use this setting for documents that contain a mixture of text and graphics.
- **Text:** Use this setting for documents that contain mostly text.
- **Picture:** Use this setting for documents that contain mostly graphics.

1. Load the document onto the scanner glass or into the document feeder.

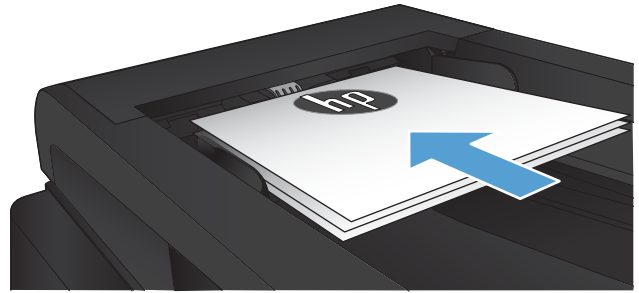

2. From the Home screen on the product control panel, touch the **Copy** button.
3. Touch the **Settings** button, and then scroll to and touch the **Optimize** button. Touch the arrow buttons to scroll through the options, and then touch an option to select it.
4. Touch the **Start Copy** button to start copying.

## Edge-to-edge copying

The product cannot print fully edge-to-edge. There is a 4 mm unprintable border around the page.

### Considerations for printing or scanning documents with cropped edges:

- When the original is smaller than the output size, move the original 4 mm (1/6 inch) away from the corner indicated by the icon on the scanner. Recopy or scan in this position.
- When the original is the size of the printed output that you want, use the **Reduce/Enlarge** feature to reduce the image so the copy is not cropped.

## Clean the pickup rollers and separation pad in the document feeder

If the product document feeder experiences paper-handling problems, such as jams or multiple-page feeds, clean the document-feeder rollers and separation pad.

1. Open the document-feeder cover.

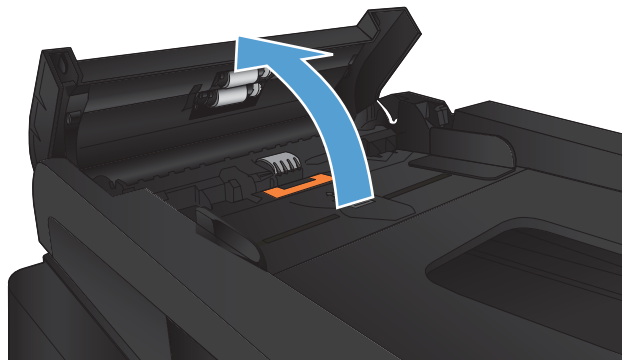

2. Use a moist, lint-free cloth to wipe both pickup rollers and the separation pad to remove dirt.

**CAUTION:** Do not use abrasives, acetone, benzene, ammonia, ethyl alcohol, or carbon tetrachloride on any part of the product; these can damage the product. Do not place liquids directly on the glass or platen. They might seep and damage the product.

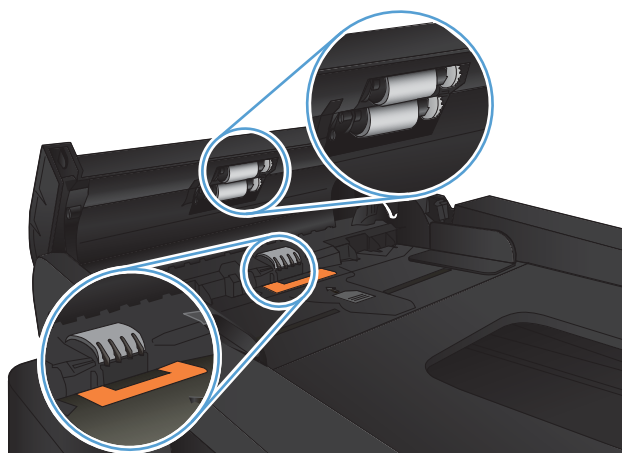

3. Close the document-feeder cover.

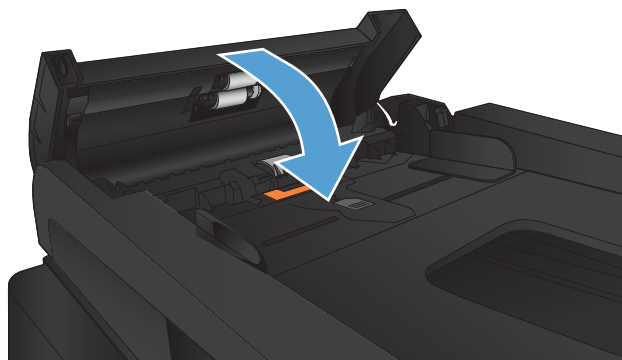

# Improve scan quality

- [Check the scanner glass for dirt and smudges](#)
- [Clean the pickup rollers and separation pad in the document feeder](#)

## Check the scanner glass for dirt and smudges

Over time, specks of debris might collect on the scanner glass and white plastic backing, which can affect performance. Use the following procedure to clean the scanner.

1. Press the power button to turn the product off, and then disconnect the power cable from the electrical outlet.

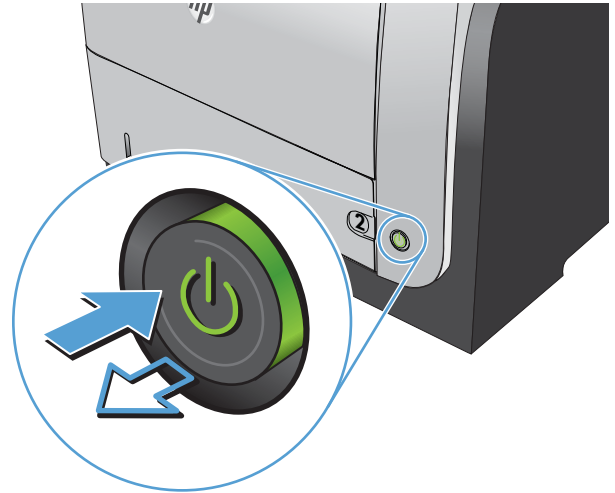

2. Open the scanner lid.
3. Clean the scanner glass, the document feeder strips, and the white plastic backing with a soft cloth or sponge that has been moistened with nonabrasive glass cleaner.

**CAUTION:** Do not use abrasives, acetone, benzene, ammonia, ethyl alcohol, or carbon tetrachloride on any part of the product; these can damage the product. Do not place liquids directly on the glass or platen. They might seep and damage the product.



4. Dry the glass and white plastic parts with a chamois or a cellulose sponge to prevent spotting.
5. Connect the power cable to an outlet, and then press the power button to turn the product on.

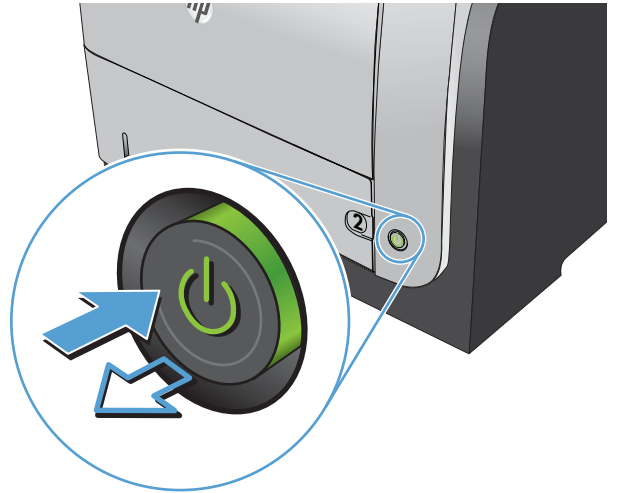

## Clean the pickup rollers and separation pad in the document feeder

If the product document feeder experiences paper-handling problems, such as jams or multiple-page feeds, clean the document-feeder rollers and separation pad.

1. Open the document-feeder cover.

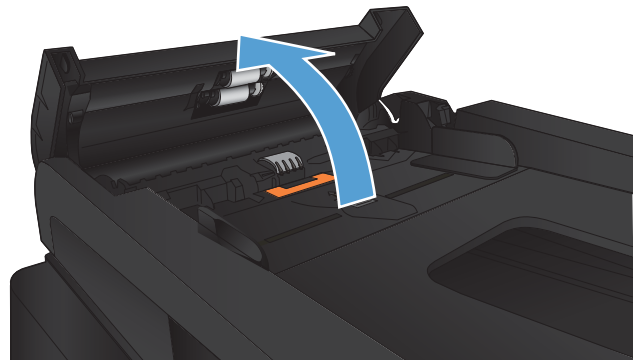

2. Use a moist, lint-free cloth to wipe both pickup rollers and the separation pad to remove dirt.

**CAUTION:** Do not use abrasives, acetone, benzene, ammonia, ethyl alcohol, or carbon tetrachloride on any part of the product; these can damage the product. Do not place liquids directly on the glass or platen. They might seep and damage the product.

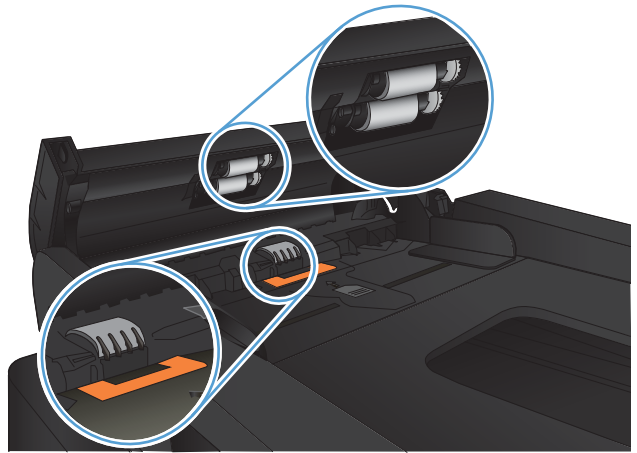

3. Close the document-feeder cover.

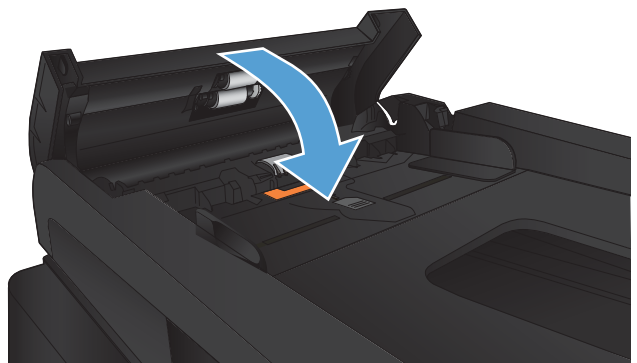

# Improve fax quality

- [Check the scanner glass for dirt and smudges](#)
- [Check the send-fax resolution setting](#)
- [Check the error correction setting](#)
- [Send to a different fax machine](#)
- [Clean the pickup rollers and separation pad in the document feeder](#)
- [Check the fit-to-page setting](#)
- [Check the sender's fax machine](#)

## Check the scanner glass for dirt and smudges

Over time, specks of debris might collect on the scanner glass and white plastic backing, which can affect performance. Use the following procedure to clean the scanner.

1. Press the power button to turn the product off, and then disconnect the power cable from the electrical outlet.

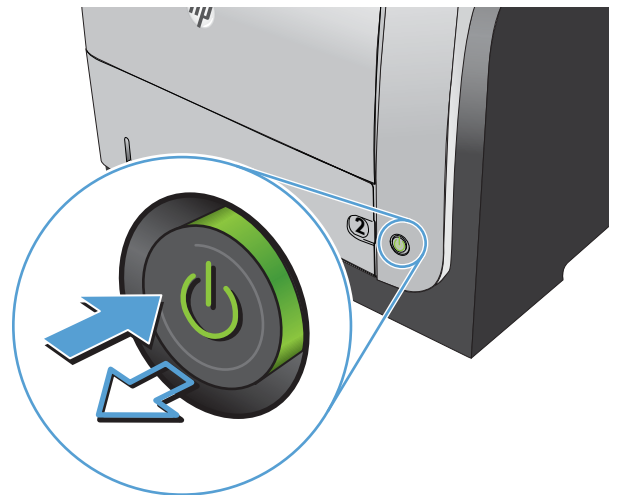

2. Open the scanner lid.

3. Clean the scanner glass, the document feeder strips, and the white plastic backing with a soft cloth or sponge that has been moistened with nonabrasive glass cleaner.

**CAUTION:** Do not use abrasives, acetone, benzene, ammonia, ethyl alcohol, or carbon tetrachloride on any part of the product; these can damage the product. Do not place liquids directly on the glass or platen. They might seep and damage the product.

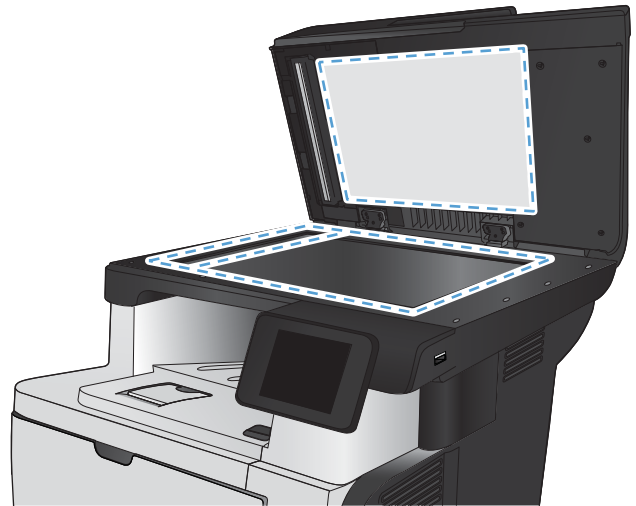

4. Dry the glass and white plastic parts with a chamois or a cellulose sponge to prevent spotting.
5. Connect the power cable to an outlet, and then press the power button to turn the product on.

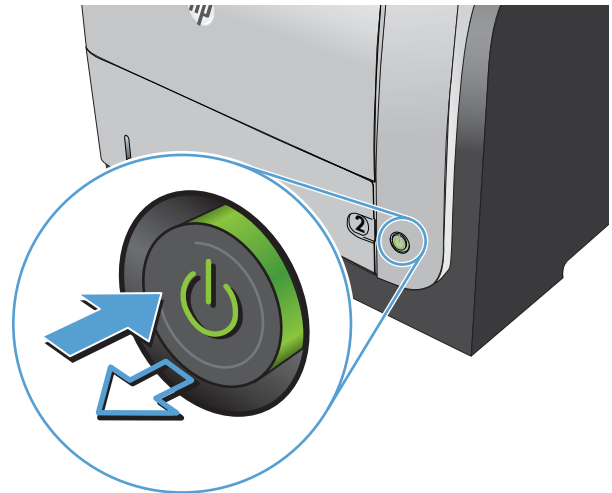

## Check the send-fax resolution setting

If the product was unable to send a fax because the receiving fax machine did not answer or was busy, the product attempts to redial based on the redial-on-busy, redial-on-no-answer, and redial-on-communication-error options.

1. From the Home screen on the product control panel, touch the Setup  button.
2. Touch the **Fax Setup** menu.
3. Touch the **Advanced Setup** menu.
4. Open the **Fax Resolution** menu.



## Check the error correction setting

Usually, the product monitors the signals on the telephone line while it is sending or receiving a fax. If the product detects an error during the transmission and the error-correction setting is **On**, the product can request that the portion of the fax be resent. The factory-set default for error correction is **On**.

You should turn off error correction only if you are having trouble sending or receiving a fax, and you are willing to accept the errors in the transmission. Turning off the setting might be useful when you are trying to send a fax overseas or receive one from overseas, or if you are using a satellite telephone connection.

1. From the Home screen on the product control panel, touch the Setup  button.
2. Touch the **Service** menu.
3. Touch the **Fax Service** menu.
4. Touch the **Error Correction** button, and then touch the **On** button.

## Send to a different fax machine

Send the fax job to a different fax machine to see if another machine will successfully receive the fax job.

## Clean the pickup rollers and separation pad in the document feeder

If the product document feeder experiences paper-handling problems, such as jams or multiple-page feeds, clean the document-feeder rollers and separation pad.

1. Open the document-feeder cover.

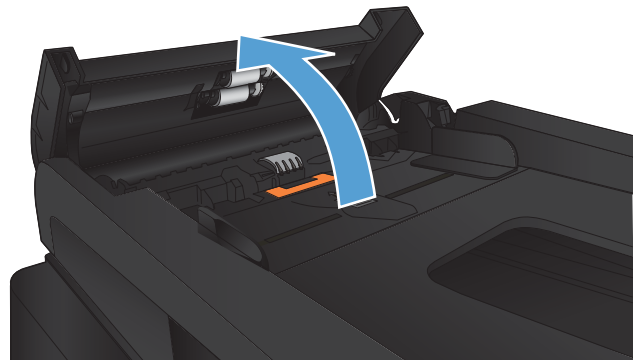

2. Use a moist, lint-free cloth to wipe both pickup rollers and the separation pad to remove dirt.

**CAUTION:** Do not use abrasives, acetone, benzene, ammonia, ethyl alcohol, or carbon tetrachloride on any part of the product; these can damage the product. Do not place liquids directly on the glass or platen. They might seep and damage the product.

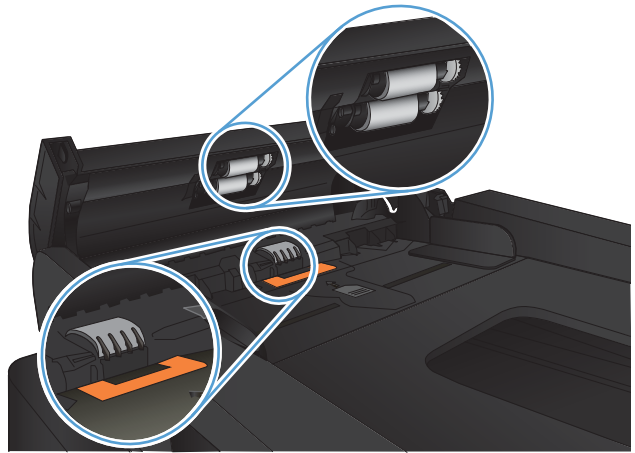

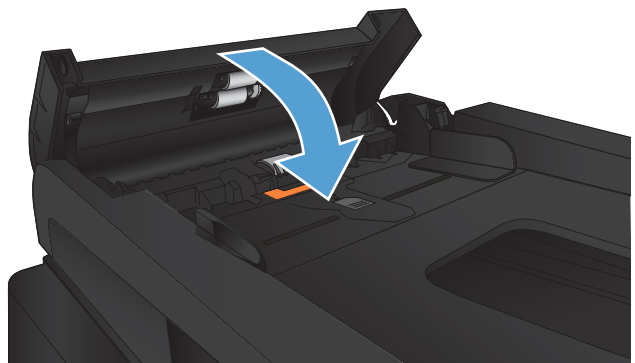

3. Close the document-feeder cover.



## Check the fit-to-page setting

If the product printed a fax job off the page, turn on the fit-to-page feature from the product control panel.

 **NOTE:** Make sure that the default paper size setting matches the size of the paper in the tray.

1. From the Home screen on the product control panel, touch the Setup  button.
2. Touch the [Fax Setup](#) menu.
3. Touch the [Advanced Setup](#) menu.
4. Touch the [Fit to Page](#) button, and then touch the [On](#) button.

## Check the sender's fax machine

Ask the sender to darken the contrast setting on the sending fax machine, and then resend the fax.

# The product does not print or it prints slowly

## The product does not print

If the product does not print at all, try the following solutions.

1. Make sure the product is turned on and that the control panel indicates it is ready.
  - If the control panel does not indicate the product is ready, turn the product off and then on again.
  - If the control panel indicates the product is ready, try sending the job again.
2. If the control panel indicates the product has an error, resolve the error and then try sending the job again.
3. Make sure the cables are all connected correctly. If the product is connected to a network, check the following items:
  - Check the light next to the network connection on the product. If the network is active, the light is green.
  - Make sure that you are using a network cable and not a phone cord to connect to the network.
  - Make sure the network router, hub, or switch is turned on and that it is working correctly.
4. Install the HP software from the CD that came with the product. Using generic print drivers can cause delays clearing jobs from the print queue.
5. From the list of printers on your computer, right-click the name of this product, click **Properties**, and open the **Ports** tab.
  - If you are using a network cable to connect to the network, make sure the printer name listed on the **Ports** tab matches the product name on the product configuration page.
  - If you are using a USB cable and are connecting to a wireless network, make sure the box is checked next to **Virtual printer port for USB**.
6. If you are using a personal firewall system on the computer, it might be blocking communication with the product. Try temporarily disabling the firewall to see if it is the source of the problem.
7. If your computer or the product is connected to a wireless network, low signal quality or interference might be delaying print jobs.

## The product prints slowly

If the product prints, but it seems slow, try the following solutions.

1. Make sure the computer meets the minimum specifications for this product. For a list of specifications, go to this Web site: [www.hp.com/support/ljmfpm521series](http://www.hp.com/support/ljmfpm521series).
2. When you configure the product to print on some paper types, such as heavy paper, the product prints more slowly so it can correctly fuse the toner to the paper. If the paper type setting is not correct for the type of paper you are using, change the setting to the correct paper type.
3. If your computer or the product is connected to a wireless network, low signal quality or interference might be delaying print jobs.

## Solve walk-up USB printing problems

- [The USB Flash Drive menu does not open when you insert the USB flash drive](#)
- [The file does not print from the USB flash drive](#)
- [The file that you want to print is not listed in the USB Flash Drive menu](#)

### The USB Flash Drive menu does not open when you insert the USB flash drive

1. You might be using a USB flash drive or a file system that this product does not support. Save the files on a standard USB flash drive that uses File Allocation Table (FAT) file systems. The product supports FAT12, FAT16, and FAT32 USB storage accessories.
2. If another menu is already open, close that menu and then reinsert the USB flash drive.
3. The USB flash drive might have multiple partitions. (Some USB flash drive manufacturers install software on the drive that creates partitions, similar to a CD.) Reformat the USB flash drive to remove the partitions, or use a different USB flash drive.
4. The USB flash drive might require more power than the product can provide.
  - a. Remove the USB flash drive.
  - b. Turn the product off and then on.
  - c. Use a USB flash drive that has its own power supply or that requires less power.
5. The USB flash drive might not be functioning correctly.
  - a. Remove the USB flash drive.
  - b. Turn the product off and then on.
  - c. Try printing from another USB flash drive.

### The file does not print from the USB flash drive

1. Make sure paper is in the tray.
2. Check the control panel for messages. If paper is jammed in the product, clear the jam.

## The file that you want to print is not listed in the USB Flash Drive menu

1. You might be trying to print a file type that the USB printing feature does not support. The product supports .PDF and .JPEG file types.
2. You might have too many files in a single folder on the USB flash drive. Reduce the number of files in the folder by moving them to subfolders.
3. You might be using a character set for the file name that the product does not support. In this case, the product replaces the file names with characters from a different character set. Rename the files using ASCII characters.

# Solve fax problems

- [Checklist for solving fax problems](#)
- [Perform a fax diagnostic test](#)
- [Fax trace report](#)
- [Fax error report printing](#)
- [Set the fax-error-correction mode](#)
- [Change the fax speed](#)
- [Solve problems sending faxes](#)
- [Solve problems receiving faxes](#)
- [Solve general fax problems](#)

## Checklist for solving fax problems

- Several possible fixes are available. After each recommended action, retry faxing to see if the problem is resolved.
  - For best results during fax problem solving, make sure the line from the product is connected directly to the wall phone port. Disconnect all other devices that are connected to the product.
1. Verify that the telephone cord is connected to the correct port on the back of the product.
  2. Check the phone line by using the fax test:
    - a. From the Home screen on the product control panel, touch the Setup  button, and then touch the [Service](#) menu.
    - b. Select the [Fax Service](#) menu.
    - c. Select the [Run Fax Test](#) option. The product prints a fax test report.

The report contains the following possible results:

- **Pass:** The report contains all of the current fax settings for review.
  - **Fail:** The report indicates the nature of the error and contains suggestions for how to resolve the issue.
3. Verify that the product firmware is current:
    - a. Print a configuration page from the control panel [Reports](#) menu to obtain the current firmware date code.
    - b. Go to [www.hp.com](http://www.hp.com).
      1. Click the **Support & Drivers** link.
      2. Click the **Download drivers and software (and firmware)** link option.

3. In the **For product** box, enter the product model number, and then click the **Go** button.
4. Click the link for your operating system.
5. Scroll to the Firmware section of the table.
  - If the listed version matches the version on the configuration page, you have the most current version.
  - If the versions are different, download the firmware upgrade file and upgrade the firmware on the product following the on-screen instructions.



**NOTE:** The product must be connected to a computer with internet access to upgrade firmware.

- Resend the fax.
4. Verify that the fax was set up when the product software was installed.

From the computer, in the HP program folder, run the Fax Setup Utility.
  5. Verify that the telephone service supports analog fax.
    - If using ISDN or digital PBX, contact your service provider for information about configuring to an analog fax line.
    - If using a VoIP service, change the **Fax Speed** setting to **Slow(V.29)** from the control panel. Ask if your service provider supports fax and for the recommended fax modem speed. Some companies might require an adapter.
    - If you are using a DSL service, make sure that a filter is included on the phone-line connection to the product. Contact the DSL service provider, or purchase a DSL filter if you do not have one. If a DSL filter is installed, try another filter because filters can be defective.
  6. If the error persists, find more detailed problem-solving solutions in the sections that follow this one.

## Perform a fax diagnostic test

From the product control panel, you can run a diagnostic test that provides information about the product fax settings.

1. From the Home screen on the product control panel, touch the Setup  button.
2. Open the following menus:
  - [Service](#)
  - [Fax Service](#)
3. Touch the [Run Fax Test](#) button to start the test. The product prints a test page that shows test results.



## Fax trace report

A fax T.30 trace report has information that can help resolve fax transmission problems. If you call HP for help in resolving these problems, print a T.30 trace report before you call.

1. From the Home screen on the product control panel, touch the Setup  button.
2. Touch the [Service](#) menu.
3. Touch the [Fax Service](#) menu.
4. Touch the [Print T.30 Trace](#) button, and then touch the [Now](#) button.

---

 **NOTE:** This procedure prints a report for the last fax job, successful or not. To generate a report for each unsuccessful fax job, select the [If Error](#) setting. To generate a report for each fax job, select the [At End of Call](#) setting.

---

## Fax error report printing

Use the following instructions to print fax logs and reports:

### Print all fax reports

Use this procedure to print all of the following reports at one time:

- Last Call Report
- Fax Activity Log
- Phone Book Report
- Junk Fax List
- Billing Report (when Billing Codes are turned on)
- Configuration Report
- Usage Page

1. From the Home screen on the product control panel, touch the [Fax](#) button.
2. Touch the [Fax Menu](#) button.
3. Touch the [Fax Reports](#) button.
4. Touch the [Print All fax Reports](#) button.

### Print individual fax reports

1. From the Home screen on the product control panel, touch the [Fax](#) button.
2. Touch the [Fax Menu](#) button.

3. Touch the **Fax Reports** button.
4. Touch the name of the report that you want to print.

## Set the fax error report

A fax error report is a brief report that indicates the product experienced a fax job error. You can set it to print after the following events:

- Every fax error (the factory-set default)
- Send fax error
- Receive fax error
- Never



**NOTE:** With this option, you will have no indication that a fax failed to be transmitted unless you print a fax activity log.

1. From the Home screen on the product control panel, touch the **Fax** button.
2. Touch the **Fax Menu** button.
3. Touch the **Fax Reports** button.
4. Touch the **Fax Error Report** button, and then touch the printing option that you want to use.

## Set the fax-error-correction mode

Usually, the product monitors the signals on the telephone line while it is sending or receiving a fax. If the product detects an error during the transmission and the error-correction setting is **On**, the product can request that the portion of the fax be resent. The factory-set default for error correction is **On**.

You should turn off error correction only if you are having trouble sending or receiving a fax, and you are willing to accept the errors in the transmission. Turning off the setting might be useful when you are trying to send a fax overseas or receive one from overseas, or if you are using a satellite telephone connection.

1. From the Home screen on the product control panel, touch the Setup  button.
2. Touch the **Service** menu.
3. Touch the **Fax Service** menu.
4. Touch the **Error Correction** button, and then touch the **On** button.

## Change the fax speed

The fax-speed setting is the modem protocol that the product uses to send faxes. It is the worldwide standard for full-duplex modems that send and receive data across telephone lines at up to 33,600 bits per second (bps). The factory-set default for the fax-speed setting is **Fast(V.34)**.

You should change the setting only if you are having trouble sending a fax to or receiving a fax from a particular device. Decreasing the fax speed might be useful when you are trying to send a fax overseas, or receive one from overseas, or if you are using a satellite telephone connection.

1. From the Home screen on the product control panel, touch the Setup  button.
2. Touch the [Fax Setup](#) menu.
3. Touch the [Advanced Setup](#) menu.
4. Scroll to and touch the [Fax Speed](#) button, and then touch the speed setting that you want to use.

## Solve problems sending faxes

- [An error message displays on the control panel](#)
- [The control panel displays a Ready message with no attempt to send the fax](#)
- [The control panel displays the message "Storing page 1" and does not progress beyond that message](#)
- [Faxes can be received, but not sent](#)
- [Product is password protected](#)
- [Unable to use fax functions from the control panel](#)
- [Unable to use speed dials](#)
- [Unable to use group dials](#)
- [Receive a recorded error message from the phone company when trying to send a fax](#)
- [Unable to send a fax when a phone is connected to the product](#)

## An error message displays on the control panel

### The Communication error message appears

- Allow the product to retry sending the fax. Re-sending temporarily reduces the fax speed.
- Disconnect the product telephone cord from the wall, connect a telephone to the phone jack on the wall, and try making a call. Connect the product phone cord to a jack for another phone line.
- Try a different phone cord.
- From the control panel, change the [Fax Speed](#) option to the [Medium\(V.17\)](#) setting or [Slow\(V.29\)](#) setting.
  - a. From the Home screen on the product control panel, touch the Setup  button.
  - b. Open the [Fax Setup](#) menu.
  - c. Open the [Advanced Setup](#) menu.

- d. Open the **Fax Speed** menu.
- e. Select the correct setting.
- Turn off the **Error Correction** option.
  - a. From the Home screen on the product control panel, touch the Setup  button.
  - b. Open the **Service** menu.
  - c. Open the **Fax Service** menu.
  - d. Open the **Error Correction** menu.
  - e. Select the **Off** setting.



**NOTE:** Turning off the **Error Correction** option can reduce image quality.

- If the error persists, contact HP. See [www.hp.com/support/ljmfpm521series](http://www.hp.com/support/ljmfpm521series) or the support flyer that came in the product box.

### No dial tone



- Make sure that the telephone cord is connected to the correct port on the product.
- Make sure that the telephone cord from the product is connected directly to the wall telephone jack.
- Check for a dial tone on the phone line by using the **Start Fax** button.
- Disconnect the product telephone cord from the wall, connect a telephone to the phone jack on the wall, and try making a voice call.
- Disconnect the telephone cord from both the product and the wall and reconnect the cord.
- Make sure that you are using the telephone cord that came with the product.
- Connect the product phone cord to a jack for another phone line.
- Check the phone line by using the **Run Fax Test** option from the **Service** menu on the control panel.
  - a. From the Home screen on the product control panel, touch the Setup  button.
  - b. Open the **Service** menu.
  - c. Open the **Fax Service** menu.
  - d. Select the **Run Fax Test** item.

### The Fax is busy message appears

- Try sending the fax again.
- Call the recipient to ensure that the fax machine is on and ready.
- Check that you are dialing the correct fax number.

- Check for a dial tone on the phone line by using the [Start Fax](#) button.
- Make sure that the phone line is working by disconnecting the product, connecting a telephone to the phone line, and making a voice call.
- Connect the product phone cord to a jack for another phone line, and try sending the fax again.
- Try a different phone cord.
- Send the fax at a later time.
- If the error persists, contact HP. See [www.hp.com/support/ljmfpm521series](http://www.hp.com/support/ljmfpm521series) or the support flyer that came in the product box.

### The No fax answer message appears

- Try to resend the fax.
- Call the recipient to ensure that the fax machine is on and ready.
- Check that you are dialing the correct fax number.
- Disconnect the product telephone cord from the wall, connect a telephone to the phone jack on the wall, and try making a voice call.
- Connect the product phone cord to a jack for another phone line.
- Try a different phone cord.
- Make sure that the phone cord from the wall telephone jack is connected to the line  port.
- Check the phone line by using the [Run Fax Test](#) option from the [Service](#) menu on the control panel.
  - From the Home screen on the product control panel, touch the Setup  button.
  - Open the [Service](#) menu.
  - Open the [Fax Service](#) menu.
  - Select the [Run Fax Test](#) item.
- If the error persists, contact HP. See [www.hp.com/support/ljmfpm521series](http://www.hp.com/support/ljmfpm521series) or the support flyer that came in the product box.

### Document feeder paper jam

- Verify that the paper meets product size requirements. The product does not support pages longer than 381 mm (15 in) for faxing.
- Copy or print the original to letter, A4, or legal size paper, and then resend the fax.

## The Fax storage is full message appears

- Turn the product off then on.
- Print stored faxes that have not been printed.
  - a. Touch the [Fax](#) button, and then touch the [Fax Menu](#) button.
  - b. Open the [Receive Options](#) menu.
  - c. Select the [Print Private Faxes](#) item.
  - d. Provide the password when the product prompts you.
- Delete stored faxes from memory.
  - a. From the Home screen on the product control panel, touch the Setup  button.
  - b. Open the [Service](#) menu.
  - c. Open the [Fax Service](#) menu.
  - d. Select the [Clear Saved Faxes](#) item.
- Divide the large fax job into smaller sections, and then fax them individually.

## Scanner error

- Verify that the paper meets product size requirements. The product does not support pages longer than 381 mm (15 in) for faxing.
- Copy or print the original onto letter, A4, or legal size paper and then resend the fax.

## The control panel displays a Ready message with no attempt to send the fax

- Check the fax activity log for errors.
  - a. Touch the [Fax](#) button, and then touch the [Fax Menu](#) button.
  - b. Open the [Fax Reports](#) menu.
  - c. Open the [Fax Activity Log](#) menu.
  - d. Select the [Print Log Now](#) option.
- If a phone is connected to the product, make sure that the phone is hung up.
- Disconnect all other lines between the fax and the product.
- Connect the product directly into the wall telephone jack and resend the fax.

## The control panel displays the message "Storing page 1" and does not progress beyond that message

- Delete stored faxes from memory.
  - a. From the Home screen on the product control panel, touch the Setup  button.
  - b. Open the [Service](#) menu.
  - c. Open the [Fax Service](#) menu.
  - d. Select the [Clear Saved Faxes](#) item.

## Faxes can be received, but not sent

Send fax and nothing happens.

1. Check for a dial tone on the phone line by using the [Start Fax](#) button.
2. Turn the product off then on.
3. Use the control panel or the HP Fax Setup Wizard to configure the fax time, date, and fax header information.
  - a. From the Home screen on the product control panel, touch the Setup  button.
  - b. Open the [Fax Setup](#) menu.
  - c. Open the [Basic Setup](#) menu.
  - d. Open the [Fax Header](#) menu.
  - e. Enter the correct settings.
4. Verify that any extension phones on the line are hung up.
5. If using a DSL service, make sure that the phone line connection to the product includes a high-pass filter.

## Product is password protected

If a network administrator has set a product password, then you must obtain the password in order to use the product fax features.

## Unable to use fax functions from the control panel

- The product might be password protected. Use the HP Embedded Web Server, HP Toolbox software, or the control panel to set a password.
- If you do not know the password for the product, contact your system administrator.
- Verify with the system administrator that the fax functionality has not been disabled.

## Unable to use speed dials

- Make sure that the fax number is valid.
- If an outside line requires a prefix, turn on the [Dial Prefix](#) option or include the prefix in the speed dial number.
  - a. From the Home screen on the product control panel, touch the Setup  button.
  - b. Open the [Fax Setup](#) menu.
  - c. Open the [Basic Setup](#) menu.
  - d. Open the [Dial Prefix](#) menu.
  - e. Select the [On](#) setting.

## Unable to use group dials

- Make sure that the fax number is valid.
- If an outside line requires a prefix, turn on the [Dial Prefix](#) option or include the prefix in the speed dial number.
  - a. From the Home screen on the product control panel, touch the Setup  button.
  - b. Open the [Fax Setup](#) menu.
  - c. Open the [Basic Setup](#) menu.
  - d. Open the [Dial Prefix](#) menu.
  - e. Select the [On](#) setting.
- Set up all entries in the group with speed dial entries.
  - a. Open an unused speed dial entry.
  - b. Enter the fax number for the speed dial.
  - c. Touch the [OK](#) button to save the speed dial.

## Receive a recorded error message from the phone company when trying to send a fax

- Make sure you dial the fax number correctly, and make sure that the phone service is not blocked. For example, some phone services might prevent long distance calling.
- If an outside line requires a prefix, turn on the [Dial Prefix](#) option or include the prefix in the speed dial number.
  - a. From the Home screen on the product control panel, touch the Setup  button.
  - b. Open the [Fax Setup](#) menu.
  - c. Open the [Basic Setup](#) menu.



- d. Open the [Dial Prefix](#) menu.
- e. Select the [On](#) setting.

 **NOTE:** To send a fax without a prefix, when the [Dial Prefix](#) option is turned on, send the fax manually.

---

- Send a fax to an international number
  - a. If a prefix is required, manually dial the telephone number with the prefix.
  - b. Enter the country/region code before dialing the phone number.
  - c. Wait for pauses as you hear the tones on the phone.
  - d. Send the fax manually from the control panel.

## Unable to send a fax when a phone is connected to the product

- Make sure that the telephone is hung up.
- Make sure that the telephone is not being used for a voice call when faxing.
- Disconnect the phone from the line, and then try sending the fax.

## Solve problems receiving faxes

- [The fax does not respond](#)
- [An error message displays on the control panel](#)
- [A fax is received but does not print](#)
- [Sender receives a busy signal](#)
- [No dial tone](#)
- [Cannot send or receive a fax on a PBX line](#)

## The fax does not respond

### The fax has a dedicated phone line



- Set the [Answer Mode](#) option to the [Automatic](#) setting from the control panel.
  - a. From the Home screen on the product control panel, touch the Setup  button.
  - b. Open the [Fax Setup](#) menu.
  - c. Open the [Basic Setup](#) menu.
  - d. Open the [Answer Mode](#) menu.
  - e. Select the [Automatic](#) setting.

## An answering machine is connected to the product

- Set the **Answer Mode** option to the **TAM** setting and connect the answering machine to the “telephone” port.

- a. From the Home screen on the product control panel, touch the Setup  button.
- b. Open the **Fax Setup** menu.
- c. Open the **Basic Setup** menu.
- d. Open the **Answer Mode** menu.
- e. Select the **TAM** setting.



If the **TAM** setting is unavailable, set the **Answer Mode** option to the **Automatic** setting.

- Set the **Rings to Answer** setting to at least one ring more than the number of rings for which the answering machine is set.
  - a. From the Home screen on the product control panel, touch the Setup  button.
  - b. Open the **Fax Setup** menu.
  - c. Open the **Basic Setup** menu.
  - d. Open the **Rings to Answer** menu.
  - e. Select the correct setting.
- Connect the answering machine to the “telephone” port.
- If the product has a telephone handset connected, set the **Answer Mode** option to the **Fax/Tel** setting to route calls to the correct device. When detecting a voice call, the product generates a ring tone that alerts you to pick up the telephone handset.
  - a. From the Home screen on the product control panel, touch the Setup  button.
  - b. Open the **Fax Setup** menu.
  - c. Open the **Basic Setup** menu.
  - d. Open the **Answer Mode** menu.
  - e. Select the **Fax/Tel** setting.

## The Answer Mode setting is set to the Manual setting

- Touch the **Start Fax** button on the product control panel.

## Voice mail is available on the fax line

- Add a distinctive ring service to your telephone line and change the **Distinctive Ring** setting on the product to match the ring pattern supplied by the telephone company. Contact your telephone company for information.
  - a. From the Home screen on the product control panel, touch the Setup  button.
  - b. Open the **Fax Setup** menu.
  - c. Open the **Basic Setup** menu.
  - d. Open the **Distinctive Ring** menu.
  - e. Select the correct setting.
- Buy a dedicated line for faxing.
- Set the **Answer Mode** option to the **Manual** setting.
  - a. From the Home screen on the product control panel, touch the Setup  button.
  - b. Open the **Fax Setup** menu.
  - c. Open the **Basic Setup** menu.
  - d. Open the **Answer Mode** menu.
  - e. Select the **Manual** setting.



---

**NOTE:** You must be present to receive faxes.

---

## The product is connected to a DSL phone service

- Check the installation and features. A DSL modem requires a high-pass filter on the phone line connection to the product. Contact your DSL service provider for a filter or buy a filter.
- Verify that the filter is connected.
- Replace the existing filter to make sure that it is not defective.

## The product uses a fax over IP or VoIP phone service

- Set the **Fax Speed** option to the **Slow(V.29)** or **Medium(V.17)** setting.
  - a. From the Home screen on the product control panel, touch the Setup  button.
  - b. Open the **Fax Setup** menu.
  - c. Open the **Advanced Setup** menu.

- d. Open the [Fax Speed](#) menu.
- e. Select the correct setting.
- Contact your service provider to make sure that fax is supported and for a recommended fax speed settings. Some companies might require an adapter.

## An error message displays on the control panel

### The No fax detected. message displays



**NOTE:** This error does not always refer to a missed fax. If a voice call is made to a fax number by mistake and the caller hangs up, the **No fax detected.** message displays on the control panel.

- Ask the sender to resend the fax.
- Make sure that the telephone cord from the product is connected to the wall telephone jack.
- Try a different phone cord.
- Connect the product phone cord to a jack for another phone line.
- Make sure the telephone line and phone wall jack are active by connecting a telephone and checking for a dial tone.
- Make sure that the telephone cord is connected to the “line” port on the product.
- Check the phone line by running a fax test from the control panel.
- If the error persists, contact HP. See [www.hp.com/support/ljmfpm521series](http://www.hp.com/support/ljmfpm521series) or the support flyer that came in the product box.

### The Communication error message appears

- Ask the sender to send the fax again or send at a later time when line conditions have improved.
- Disconnect the product telephone cord from the wall, connect a telephone to the phone jack on the wall, and try making a call. Plug the product phone cord into a jack for another phone line.
- Try a different phone cord.
- Set the [Fax Speed](#) option to the [Slow\(V.29\)](#) or [Medium\(V.17\)](#) setting.
  - a. From the Home screen on the product control panel, touch the Setup  button.
  - b. Open the [Fax Setup](#) menu.
  - c. Open the [Advanced Setup](#) menu.
  - d. Open the [Fax Speed](#) menu.
  - e. Select the correct setting.
- Turn off the [Error Correction](#) feature to prevent automatic error correction.



**NOTE:** Turning off the [Error Correction](#) feature can reduce image quality.

- a. From the Home screen on the product control panel, touch the Setup button.
  - b. Open the [Service](#) menu.
  - c. Open the [Fax Service](#) menu.
  - d. Open the [Error Correction](#) menu.
  - e. Select the [Off](#) setting.
- Print the [Fax Activity Log](#) report from the control panel to determine if the error occurs with a specific fax number.
    - a. Touch the [Fax](#) button, and then touch the [Fax Menu](#) button.
    - b. Open the [Fax Reports](#) menu.
    - c. Open the [Fax Activity Log](#) menu.
    - d. Select the [Print Log Now](#) option.
  - If the error persists, contact HP. See [www.hp.com/support/ljmfpm521series](http://www.hp.com/support/ljmfpm521series) or the support flyer that came in the product box.

### The Fax storage is full message appears

- Turn the product off then on.
- Print all of the faxes, and then have the sender resend the fax.
- Ask the sender to divide a large fax job into smaller sections, and then fax them individually.
- Make sure that the resolution of the sending fax machine is not set to the [Photo](#) setting or the [Superfine](#) setting.
  - a. From the Home screen on the product control panel, touch the Setup button.
  - b. Open the [Fax Setup](#) menu.
  - c. Open the [Advanced Setup](#) menu.
  - d. Open the [Fax Resolution](#) menu.
  - e. Select the correct setting.
- Cancel all fax jobs or clear the faxes from memory.

### The Fax is busy message appears

- The product cannot receive a fax while attempting to send one. Cancel the fax send and try sending at a later time.
- Allow the product to try sending the fax again.

## A fax is received but does not print

### The Private Receive feature is on

- When the [Private Receive](#) feature is activated, received faxes are stored in memory. A password is required to print the stored faxes.
- Enter the password to print the fax. If you do not know the password, contact the product administrator.



**NOTE:** Memory errors might occur if the faxes are not printed. The product will not answer if the memory is full.

## Sender receives a busy signal

### A handset is connected to the product

- Make sure the phone is hung up.
- Change the [Answer Mode](#) option to match the product setup.
  - a. From the Home screen on the product control panel, touch the Setup  button.
  - b. Open the [Fax Setup](#) menu.
  - c. Open the [Basic Setup](#) menu.
  - d. Open the [Answer Mode](#) menu.
  - e. Select the setting that matches the product setup.

Set the [Answer Mode](#) option to the [Fax/Tel](#) setting to automatically receive faxes. The [Fax/Tel](#) setting automatically detects whether the incoming transmission is a fax or a voice call and routes the call to the appropriate device.

### A phone line splitter is being used

- If you are using a phone line splitter, remove the splitter and set up the phone as a downstream phone.
- Make sure the phone is hung up.
- Make sure the phone is not being used for a voice call when faxing.

## No dial tone

- If using a phone line splitter, remove the phone line splitter and set up the phone as a downstream phone.

## Cannot send or receive a fax on a PBX line

- If you are using a PBX phone line, contact your PBX administrator to configure an analog fax line for your product.

## Solve general fax problems

- [Faxes are sending slowly](#)
- [Fax quality is poor](#)
- [Fax cuts off or prints on two pages](#)

### Faxes are sending slowly

The product is experiencing poor phone line quality.

- Retry sending the fax when the line conditions have improved.
- Check with the phone service provider that the line supports fax.
- Turn off the [Error Correction](#) setting.
  - a. Open the [Setup Menu](#) menu.
  - b. Open the [Service](#) menu.
  - c. Open the [Fax Service](#) menu.
  - d. Open the [Error Correction](#) menu.
  - e. Select the [Off](#) setting.

---

 **NOTE:** This can reduce image quality.

---

- Use white paper for the original. Do not use colors such as gray, yellow, or pink.
- Increase the [Fax Speed](#) setting.
  - a. Open the [Setup Menu](#) menu.
  - b. Open the [Fax Setup](#) menu.
  - c. Open the [Advanced Setup](#) menu.
  - d. Open the [Fax Speed](#) menu.
  - e. Select the correct setting.
- Divide large fax jobs into smaller sections, and then fax them individually.
- Change the fax settings on the control panel to a lower resolution.
  - a. Open the [Setup Menu](#) menu.
  - b. Open the [Fax Setup](#) menu.
  - c. Open the [Advanced Setup](#) menu.
  - d. Open the [Fax Resolution](#) menu.
  - e. Select the correct setting.

## Fax quality is poor

Fax is blurry or light.

- Increase fax resolution when sending faxes. Resolution does not affect received faxes.
  - a. Open the [Setup Menu](#) menu.
  - b. Open the [Fax Setup](#) menu.
  - c. Open the [Advanced Setup](#) menu.
  - d. Open the [Fax Resolution](#) menu.
  - e. Select the correct setting.



---

**NOTE:** Increasing resolution slows transmission speed.

---

- Turn on the [Error Correction](#) setting from the control panel.
  - a. Open the [Setup Menu](#) menu.
  - b. Open the [Service](#) menu.
  - c. Open the [Fax Service](#) menu.
  - d. Open the [Error Correction](#) menu.
  - e. Select the [On](#) setting.
- Check the toner cartridges and replace if necessary.
- Ask the sender to darken the contrast setting on the sending fax machine, and then resend the fax.

## Fax cuts off or prints on two pages

- Set the [Default Paper Size](#) setting. Faxes print on a single size of paper based on the [Default Paper Size](#) settings.
  - a. Open the [Setup Menu](#) menu.
  - b. Open the [System Setup](#) menu.
  - c. Open the [Paper Setup](#) menu.
  - d. Open the [Default Paper Size](#) menu.
  - e. Select the correct setting.
- Set the paper type and size for the tray used for faxes.
- Turn on the [Fit to Page](#) setting to print longer length faxes on letter or A4 size paper.
  - a. Open the [Setup Menu](#) menu.
  - b. Open the [Fax Setup](#) menu.



- c. Open the [Advanced Setup](#) menu.
- d. Open the [Fit to Page](#) menu.
- e. Select the [On](#) setting.



**NOTE:** If the [Fit to Page](#) setting is off and the [Default Paper Size](#) setting is set to letter, a legal size original prints on two pages.

---

## Solve USB connection problems

If you have connected the product directly to a computer, check the cable.

- Verify that the cable is connected to the computer and to the product.
- Verify that the cable is not longer than 5 m (16.4 ft). Try using a shorter cable.
- Verify that the cable is working correctly by connecting it to another product. Replace the cable if necessary.

# Solve wired network problems

Check the following items to verify that the product is communicating with the network. Before beginning, print a configuration page from the product control panel and locate the product IP address that is listed on this page.

- [Poor physical connection](#)
- [The computer is using the incorrect IP address for the product](#)
- [The computer is unable to communicate with the product](#)
- [The product is using incorrect link and duplex settings for the network](#)
- [New software programs might be causing compatibility problems](#)
- [The computer or workstation might be set up incorrectly](#)
- [The product is disabled, or other network settings are incorrect](#)



**NOTE:** HP does not support peer-to-peer networking, as the feature is a function of Microsoft operating systems and not of the HP print drivers. For more information, go to Microsoft at [www.microsoft.com](http://www.microsoft.com).

## Poor physical connection

1. Verify that the product is attached to the correct network port using a cable of the correct length.
2. Verify that cable connections are secure.
3. Look at the network port connection on the back of the product, and verify that the amber activity light and the green link-status light are lit.
4. If the problem continues, try a different cable or port on the hub.

## The computer is using the incorrect IP address for the product

1. Open the printer properties and click the **Ports** tab. Verify that the current IP address for the product is selected. The product IP address is listed on the product configuration page.
2. If you installed the product using the HP standard TCP/IP port, select the box labeled **Always print to this printer, even if its IP address changes**.
3. If you installed the product using a Microsoft standard TCP/IP port, use the hostname instead of the IP address.
4. If the IP address is correct, delete the product and then add it again.

## The computer is unable to communicate with the product

1. Test network communication by pinging the network.
  - a. Open a command-line prompt on your computer. For Windows, click **Start**, click **Run**, and then type `cmd`.
  - b. Type `ping` followed by the IP address for your product.

For Mac OS X, open the Network Utility, and then supply the IP address in the correct field in the **Ping** pane.
  - c. If the window displays round-trip times, the network is working.
2. If the ping command failed, verify that the network hubs are on, and then verify that the network settings, the product, and the computer are all configured for the same network.

## The product is using incorrect link and duplex settings for the network

Hewlett-Packard recommends leaving this setting in automatic mode (the default setting). If you change these settings, you must also change them for your network.

## New software programs might be causing compatibility problems

Verify that any new software programs are correctly installed and that they use the correct print driver.

## The computer or workstation might be set up incorrectly

1. Check the network drivers, print drivers, and the network redirection.
2. Verify that the operating system is configured correctly.

## The product is disabled, or other network settings are incorrect

1. Review the configuration page to check the status of the network protocol. Enable it if necessary.
2. Reconfigure the network settings if necessary.

# Solve wireless network problems

- [Wireless connectivity checklist](#)
- [The product does not print after the wireless configuration completes](#)
- [The product does not print, and the computer has a third-party firewall installed](#)
- [The wireless connection does not work after moving the wireless router or product](#)
- [Cannot connect more computers to the wireless product](#)
- [The wireless product loses communication when connected to a VPN](#)
- [The network does not appear in the wireless networks list](#)
- [The wireless network is not functioning](#)
- [Perform a wireless network diagnostic test](#)
- [Reduce interference on a wireless network](#)

## Wireless connectivity checklist

- Verify that the network cable is not connected.
- Verify that the product and the wireless router are turned on and have power. Also make sure that the wireless radio in the product is turned on.
- Verify that the service set identifier (SSID) is correct. Print a configuration page to determine the SSID. If you are not sure the SSID is correct, run the wireless setup again.
- With secured networks, verify that the security information is correct. If the security information is incorrect, run the wireless setup again.
- If the wireless network is working correctly, try accessing other computers on the wireless network. If the network has Internet access, try connecting to the Internet over a wireless connection.
- Verify that the encryption method (AES or TKIP) is the same for the product as it is for the wireless access point (on networks using WPA/WPA2 security).
- Verify that the product is within the range of the wireless network. For most networks, the product must be within 30 m (100 ft) of the wireless access point (wireless router).
- Verify that obstacles do not block the wireless signal. Remove any large metal objects between the access point and the product. Make sure poles, walls, or support columns containing metal or concrete do not separate the product and wireless access point.
- Verify that the product is located away from electronic devices that might interfere with the wireless signal. Many devices can interfere with the wireless signal including motors, cordless phones, security system cameras, other wireless networks, and some Bluetooth devices.
- Verify that the print driver is installed on the computer.
- Verify that you have selected the correct printer port.

- Verify that the computer and product connect to the same wireless network.
- For Mac OS X, verify that the wireless router supports Bonjour.

## The product does not print after the wireless configuration completes

1. Make sure that the product is turned on and in the ready state.
2. Turn off any third-party firewalls on your computer.
3. Make sure that the wireless network is working correctly.
4. Make sure that your computer is working correctly. If necessary, restart the computer.
5. Verify that you can open the product HP Embedded Web Server from a computer on the network.

## The product does not print, and the computer has a third-party firewall installed

1. Update the firewall with the most recent update available from the manufacturer.
2. If programs request firewall access when you install the product or try to print, make sure you allow the programs to run.
3. Temporarily turn off the firewall, and then install the wireless product on the computer. Enable the firewall when you have completed the wireless installation.

## The wireless connection does not work after moving the wireless router or product

1. Make sure that the router or product connects to the same network that your computer connects to.
2. Print a configuration page.
3. Compare the service set identifier (SSID) on the configuration page to the SSID in the printer configuration for the computer.
4. If the numbers are not the same, the devices are not connecting to the same network. Reconfigure the wireless setup for the product.

## Cannot connect more computers to the wireless product

1. Make sure that the other computers are within the wireless range and that no obstacles block the signal. For most networks, the wireless range is within 30 m (100 ft) of the wireless access point.
2. Make sure that the product is turned on and in the ready state.
3. Turn off any third-party firewalls on your computer.

4. Make sure that the wireless network is working correctly.
5. Make sure that your computer is working correctly. If necessary, restart the computer.

## The wireless product loses communication when connected to a VPN

- Typically, you cannot connect to a VPN and other networks at the same time.

## The network does not appear in the wireless networks list

- Make sure the wireless router is turned on and has power.
- The network might be hidden. However, you can still connect to a hidden network.

## The wireless network is not functioning

1. Make sure that the network cable is not connected.
2. To verify if the network has lost communication, try connecting other devices to the network.
3. Test network communication by pinging the network.
  - a. Open a command-line prompt on your computer. For Windows, click **Start**, click **Run**, and then type `cmd`.
  - b. Type `ping` followed by the router IP address.

For Mac OS X, open the Network Utility, and then supply the IP address in the correct field in the **Ping** pane.
  - c. If the window displays round-trip times, the network is working.
4. Make sure that the router or product connects to the same network that the computer connects to.
  - a. Print a configuration page.
  - b. Compare the service set identifier (SSID) on the configuration report to the SSID in the printer configuration for the computer.
  - c. If the numbers are not the same, the devices are not connecting to the same network. Reconfigure the wireless setup for the product.

## Perform a wireless network diagnostic test

From the product control panel, you can run a diagnostic test that provides information about the wireless network settings.

1. From the Home screen on the product control panel, touch the Setup  button.
2. Open the [Self Diagnostics](#) menu.
3. Touch the [Run Wireless Test](#) button to start the test. The product prints a test page that shows test results.

## Reduce interference on a wireless network

The following tips can reduce interference in a wireless network:

- Keep the wireless devices away from large metal objects, such as filing cabinets, and other electromagnetic devices, such as microwaves and cordless telephones. These objects can disrupt radio signals.
- Keep the wireless devices away from large masonry structures and other building structures. These objects can absorb radio waves and lower signal strength.
- Position the wireless router in a central location in line of sight with the wireless products on the network.



# Solve product software problems with Windows

- [A print driver for the product is not visible in the Printer folder](#)
- [An error message was displayed during the software installation](#)
- [The product is in Ready mode, but nothing prints](#)

## A print driver for the product is not visible in the Printer folder

1. Reinstall the product software.

 **NOTE:** Close any applications that are running. To close an application that has an icon in the system tray, right-click the icon, and select **Close** or **Disable**.

2. Try connecting the USB cable to a different USB port on the computer.

## An error message was displayed during the software installation

1. Reinstall the product software.

 **NOTE:** Close any applications that are running. To close an application that has an icon in the system tray, right-click the icon, and select **Close** or **Disable**.

2. Check the amount of free space on the drive where you are installing the product software. If necessary, free up as much space as you can, and reinstall the product software.
3. If necessary, run the Disk Defragmenter, and reinstall the product software.

## The product is in Ready mode, but nothing prints

1. Print a configuration page, and verify the product functionality.
2. Verify that all of the cables are correctly seated and within specifications. This includes the USB and power cables. Try a new cable.
3. Verify the IP address on the configuration page matches the IP address for the software port. Use one of the following procedures:

### Windows XP, Windows Server 2003, Windows Server 2008, and Windows Vista

- a. Click **Start**.
- b. Click **Settings**.
- c. Click **Printers and Faxes** (using the default Start menu view) or click **Printers** (using the Classic Start menu view).
- d. Right-click the product driver icon, and then select **Properties**.
- e. Click the **Ports** tab, and then click **Configure Port**.

- f. Verify the IP address, and then click **OK** or **Cancel**.
- g. If the IP addresses are not the same, delete the driver, and reinstall the driver using the correct IP address.

## Windows 7

- a. Click **Start**.
- b. Click **Devices and Printers**.
- c. Right-click the product driver icon, and then select **Printer properties**.
- d. Click the **Ports** tab, and then click **Configure Port**.
- e. Verify the IP address, and then click **OK** or **Cancel**.
- f. If the IP addresses are not the same, delete the driver, and reinstall the driver using the correct IP address.

# Solve product software problems with Mac OS X

- [The print driver is not listed in the Print & Fax or Print & Scan list](#)
- [The product name does not appear in the product list in the Print & Fax or Print & Scan list](#)
- [The print driver does not automatically set up the selected product in the Print & Fax or Print & Scan list](#)
- [A print job was not sent to the product that you wanted](#)
- [When connected with a USB cable, the product does not appear in the Print & Fax or Print & Scan list after the driver is selected.](#)
- [You are using a generic print driver when using a USB connection](#)

## The print driver is not listed in the Print & Fax or Print & Scan list

1. Make sure that the product .GZ file is in the following hard-drive folder: Library/Printers/PPDs/Contents/Resources. If necessary, reinstall the software.
2. If the GZ file is in the folder, the PPD file might be corrupt. Delete the file and then reinstall the software.

## The product name does not appear in the product list in the Print & Fax or Print & Scan list

1. Make sure that the cables are connected correctly and the product is on.
2. Print a configuration page to check the product name. Verify that the name on the configuration page matches the product name in the **Print & Fax (Print & Scan** in Mac OS X v10.7) list.
3. Use the + button to add the product to the **Print & Fax (Print & Scan** in Mac OS X v10.7) list.
4. Replace the USB or network cable with a high-quality cable.

## The print driver does not automatically set up the selected product in the Print & Fax or Print & Scan list

1. Make sure that the cables are connected correctly and the product is on.
2. Make sure that the product .GZ file is in the following hard-drive folder: Library/Printers/PPDs/Contents/Resources. If necessary, reinstall the software.
3. If the GZ file is in the folder, the PPD file might be corrupt. Delete the file and then reinstall the software.
4. Use the + button to add the product to the **Print & Fax (Print & Scan** in Mac OS X v10.7) list.
5. Replace the USB or network cable with a high-quality cable.

## A print job was not sent to the product that you wanted

1. Open the print queue and restart the print job.
2. Another product with the same or similar name might have received your print job. Print a configuration page to check the product name. Verify that the name on the configuration page matches the product name in the **Print & Fax** (**Print & Scan** in Mac OS X v10.7) list.

## When connected with a USB cable, the product does not appear in the Print & Fax or Print & Scan list after the driver is selected.

### Software troubleshooting

1. Make sure that your Mac operating system is Mac OS X 10.6 or later.
2. Use the + button to add the product to the **Print & Fax** (**Print & Scan** in Mac OS X v10.7) list.

### Hardware troubleshooting

1. Make sure that the product is turned on.
2. Make sure that the USB cable is connected correctly.
3. Make sure that you are using the appropriate Hi-Speed USB cable.
4. Make sure that you do not have too many USB devices drawing power from the chain. Disconnect all of the devices from the chain, and then connect the cable directly to the USB port on the computer.
5. Check to see if more than two non-powered USB hubs are connected in a row on the chain. Disconnect all of the devices from the chain, and then connect the cable directly to the USB port on the computer.

---

 **NOTE:** The iMac keyboard is a non-powered USB hub.

---

## You are using a generic print driver when using a USB connection

If you connected the USB cable before you installed the software, you might be using a generic print driver instead of the driver for this product.

1. Delete the generic print driver.
2. Reinstall the software from the product CD. Do not connect the USB cable until the software installation program prompts you.
3. If multiple printers are installed, make sure that you have selected the correct printer in the **Format For** drop-down menu in the **Print** dialog box.

# Remove software (Windows)

## Windows XP

1. Click **Start**, and then click **Programs**.
2. Click **HP**, and then click the product name.
3. Click **Uninstall**, and then follow the on-screen instructions to remove the software.

## Windows Vista and Windows 7

1. Click **Start**, and then click **All Programs**.
2. Click **HP**, and then click the product name.
3. Click **Uninstall**, and then follow the on-screen instructions to remove the software.

## Remove software (Mac OS X)

You must have administrator rights to remove the software.

1. Disconnect the product from the computer.
2. Open **Applications**.
3. Open **Hewlett Packard**.
4. Open **HP Uninstaller**.
5. Select the product from the list of devices, and then click the **Uninstall** button.
6. After the software is uninstalled, restart the computer and empty the Trash.

## Solve scan to email problems

If scan to email problems occur, try these solutions:

- Make sure this feature has been set up. If this feature has not been set up, use the setup wizard in the HP Device Toolbox (Windows) or HP Utility for Mac OS X software to set it up.
- Make sure the Scan to Email feature is enabled. If it has been disabled, enable the feature through the HP Device Toolbox (Windows) or HP Utility for Mac OS X software.
- Make sure the product is connected to a computer or to a network.

### Cannot connect to the email server

- Make sure the SMTP server name is correct. Check this setting with your system administrator or Internet Service Provider.
- If the product cannot establish a secure connection to the SMTP server, try without the secure connection or try a different server or port. Check this setting with your system administrator or Internet Service Provider.
- If the SMTP server requires authentication, make sure a valid user name and password are used.
- If the SMTP server uses an authentication method that is not supported, try a different server. Check this setting with your system administrator or Internet Service Provider.

### The email failed

- Verify that email addresses entered are correct.
- If the size of the email was too large, send fewer pages or reduce the scan resolution.

### Unable to scan

- If you are prompted for a PIN, enter the correct PIN for the outgoing profile.
- Make sure at least one email address is selected in the **To** field.

# Solve scan to network folder problems

If scan to network folder problems occur, try these solutions:

- Make sure this feature has been set up. If this feature has not been set up, use the setup wizard in the HP Device Toolbox (Windows) or HP Utility for Mac OS X software to set it up.
- Make sure the Scan to Network Folder feature is enabled. If it has been disabled, enable the feature through the HP Device Toolbox (Windows) or HP Utility for Mac OS X software.
- Make sure the product is connected to a network.
- Use the test option on the Scan tab of the HP Device Toolbox (Windows) or the HP Utility (Mac OS X) to verify the Scan to Network Folder feature is set up correctly.

## The scan failed

- Make sure the network path is in the correct format (//host/share/path) and the folder exists.
- Make sure the network directory is readable and writeable.
- If you are using the default file names for scanned documents, make sure there are no conflicting file names. Remove some of the previously scanned documents.
- Use the IP address instead of the host name. Make sure the product and host are connected to the same network.
- If the network folder is password protected, make sure to enter the correct user name and password.
- If a [Disk full](#) message displays, remove some files from the network folder.
- Turn the product off, and then on. Scan again.



# Index

## A

- Accessories
  - part numbers 33
- accessories
  - ordering 26
- AirPrint 81
- answer mode, setting 122
- answering machines, connecting
  - 111
  - fax settings 123
- anticounterfeit supplies 28
- applications
  - downloading 144
- Apps menu 144
- archival-quality printing 79
- autoreduction settings, fax 125

## B

- billing codes, fax
  - using 120
- bins, output
  - locating 4
  - selecting 23
- blocking faxes 123
- booklets
  - creating (Windows) 69
  - printing (Mac) 76
- busy signals, redialing options 118

## C

- caller-ID boxes, connecting 111
- canceling
  - faxes 128
  - print job (Mac) 78
  - print job (Windows) 72
- cartridges
  - non-HP 27, 35
  - order numbers 35

- recycling 35
- replacing 36
- storage 35
- supplies status page 11
- checklist
  - fax troubleshooting 201
  - for solving problems 158
  - wireless connectivity 223
- cleaning
  - glass 186, 190, 193
  - paper path 182
- collating copies 90
- configuration page 11
- contrast settings
  - copy 95
  - fax 119
- control panel
  - buttons and lights 8
  - help 10, 162
  - Home screen 9
  - locating 4
  - menu map, printing 11
  - Reports menu 11
- copying
  - collation 90
  - contrast, adjusting 95
  - draft mode 96
  - enlarging 93
  - light/dark settings 95
  - multiple copies 87
  - multiple-page originals 88
  - paper size and type 97
  - quality, adjusting 94
  - reducing 93
  - restore default settings 85
  - set new default settings 84
  - single copies 86
  - two-sided documents 91, 92
- counterfeit supplies 28

- cover pages
  - printing on different paper (Windows) 64
- covers, locating 4
- custom-size copies 93
- customer self-repair
  - part numbers 31

## D

- darkness, contrast settings
  - copy 95
  - fax 119
- default copy settings
  - changing 84
  - restoring to factory settings 85
- default gateway, setting 145
- defaults, restoring 161
- delaying fax sending 135
- deleting faxes from memory 129
- dial tone detection settings 118
- dialing
  - from a telephone 134
  - pauses, inserting 117
  - prefixes, inserting 117
  - redialing automatically, settings 118
  - tone or pulse settings 118
- distinctive-ring settings 124
- document feeder 91
  - copying two-sided documents 91
  - jams 166
  - paper-feeding problems 164
- double-sided copying 91, 92
- double-sided printing
  - Mac 75
  - Windows 53
- draft mode, copying 96

- drivers
  - changing paper sizes 70
  - changing settings (Mac) 44
  - changing settings (Windows) 42
  - paper types 16
  - presets (Mac) 73
  - selecting 184
  - settings (Mac) 73
  - universal 40
  - usage page 11
- DSL
  - faxing 129
- duplex 91
- duplex printing
  - Mac 74, 75
- duplex printing (double-sided)
  - settings (Windows) 51
  - Windows 53
- duplex settings, changing 147
- duplexer
  - jams 179
- duplexing
  - manually (Mac) 75
  - manually (Windows) 53
- E**
- EconoMode setting 152, 184
- economy settings 152
- electronic faxes
  - sending 133
- Embedded Web Server 160
  - changing network settings 145
  - changing password 154
  - changing product name 146
  - opening 145, 146, 154
- enlarging documents
  - copying 93
- envelopes
  - output bin, selecting 23
- error messages, fax 205, 211
- error report, fax
  - printing 204
- error-correction setting, fax 204
- errors
  - software 227
- extension phones
  - receiving faxes from 112
  - sending faxes from 134
- F**
- factory-set defaults, restoring 161
- fax
  - answer mode 122
  - autoreduction 125
  - billing codes 120
  - blocking 123
  - canceling 128
  - confirming number 134
  - contrast setting 119
  - delaying sending 135
  - deleting from memory 129
  - detect-dial-tone settings 118
  - dial prefixes 117
  - dialing, tone or pulse 118
  - error report, printing 204
  - error-correction 204
  - extension phone receiving 112
  - forwarding 122
  - pauses, inserting 117
  - polling 127
  - printing 137
  - printing private faxes 139
  - private receive 126
  - receiving when you hear fax tones 139
  - redial settings 118
  - reports, printing all 203
  - reprinting faxes 125
  - reprinting from memory 138
  - resolution 119
  - ring patterns 124
  - rings-to-answer 123
  - security, private receive 126
  - sending from a telephone 134
  - sending from software 133
  - solve general problems 217
  - solving problems 160
  - speed dials 133
  - stamp-received 126
  - unable to receive 211
  - unable to send 205
  - using DSL, PBX, or ISDN 129
  - using VoIP 130
  - V.34 setting 204
  - volume settings 126
- fax date, setup
  - use control panel 113
  - use HP Fax Setup Wizard 114
- fax header, setup
  - use control panel 113
  - use HP Fax Setup Wizard 114
- fax time, setup
  - use control panel 113
  - use HP Fax Setup Wizard 114
- fax troubleshooting
  - checklist 201
- faxing
  - from a computer (Mac) 133
  - from a computer (Windows) 133
- first page
  - printing on different paper (Windows) 64
- Fit to Page setting, fax 125
- fonts
  - lists, printing 11
- forwarding faxes 122
- fraud Web site 28
- fuser
  - jams 177
- G**
- gateway, setting default 145
- glass, cleaning 186, 190, 193
- group-dial entries
  - creating 115
  - deleting 116
  - editing 115
- H**
- heavy paper
  - output bin, selecting 23
- help, control panel 10, 162
- Home screen, control panel 9
- HP Device Toolbox, using 148
- HP Embedded Web Server 160
  - changing network settings 145
  - changing password 154
  - changing product name 146
  - opening 145, 146, 154
- HP ePrint, using 80
- HP fraud Web site 28
- HP Reconfiguration Utility
  - network installation 142
- HP Scan software (Mac) 101
- HP Scan software (Windows) 100
- HP Universal Print Driver 40
- HP Utility 150

- HP Utility for Mac
  - Bonjour 150
  - features 150
- HP Utility, Mac 150
- HP Web Jetadmin 151
- HP Web Services
  - applications 144
  - enabling 144
- HP Web Services, enabling 80

**I**

- identification cards
  - copying 89
- interface ports
  - locating 5, 6
- IPv4 address 145
- ISDN
  - faxing 129

**J**

- jams
  - causes of 164
  - document feeder, clearing 166
  - duplexer 179
  - fuser 177
  - locations 165
  - output bin 168
  - tracking number of 11
  - Tray 1 170
  - Tray 2 173
- Jetadmin, HP Web 151

**L**

- labels
  - output bin, selecting 23
  - printing (Windows) 61
- landscape orientation
  - changing (Mac) 75
  - selecting, Windows 59
- last page
  - printing on different paper (Windows) 64
- lightness
  - copy contrast 95
  - fax contrast 119
- link speed settings 147
- loading
  - toner cartridges 34
  - Tray 1 18
  - Tray 2 21

- lock
  - product 154
- logs, fax
  - error 204
  - printing all 203

**M**

- Mac
  - driver settings 44, 73
  - problems, troubleshooting 229
  - scanning from TWAIN-compliant software 107
- Macintosh
  - HP Utility 150
- maintenance kits
  - part numbers 31
- managing network 145
- manual duplex
  - Mac 75
  - Windows 53
- media
  - loading Tray 1 18
  - loading Tray 2 21
- memory
  - deleting faxes 129
  - included 2
  - reprinting faxes 138
- menus, control panel
  - map, printing 11
- Microsoft Word, faxing from 134
- modems, connecting 111
- multiple copies 87
- multiple pages per sheet
  - printing (Mac) 75
  - printing (Windows) 57
- multiple-page originals
  - copying 88

**N**

- network
  - password, changing 154
  - password, setting 154
  - product name, changing 146
  - settings, changing 145
  - settings, viewing 145
- networks
  - configuration page 11
  - default gateway 145
  - HP Web Jetadmin 151
  - installing the product 142

- IPv4 address 145
- models supporting 2
- settings report 11
- subnet mask 145
- non-HP supplies 27, 35
- number of copies, changing 87

**O**

- on/off button, locating 4
- online help, control panel 10, 162
- ordering
  - supplies and accessories 26
- orientation
  - changing (Mac) 75
  - selecting, Windows 59
- output bin
  - jams 168
  - locating 4
- outside lines
  - dial prefixes 117
  - pauses, inserting 117

**P**

- page count 11
- page orientation
  - changing (Mac) 75
- page sizes
  - scaling documents to fit (Mac) 76
  - scaling documents to fit (Windows) 67
- pages per minute 2
- pages per sheet
  - selecting (Mac) 75
  - selecting (Windows) 57
- paper
  - covers, using different paper 64
  - fax autoreduction settings 125
  - first and last pages, using different paper 64
  - jams 164
  - loading Tray 1 18
  - loading Tray 2 21
  - ordering 26
  - selecting 183
  - supported paper sizes 14
  - supported sizes 14
  - supported types 16

- paper jams. *See* jams
  - paper pickup problems
    - solving 163
  - paper size
    - changing 70
  - paper sizes
    - copy settings 97
    - selecting (Mac) 77
    - selecting custom sizes (Mac) 77
    - selecting custom sizes (Windows) 70
  - paper type
    - selecting (Windows) 61
  - paper types
    - copy settings 97
    - selecting (Mac) 76
  - paper, covers
    - printing (Mac) 76
  - part numbers
    - customer self-repair 31
    - maintenance kits 31
    - supplies 31
    - trays 33
  - pauses, inserting 117
  - PBX
    - faxing 129
  - PCL drivers
    - universal 40
  - PCL font list 11
  - phone book, fax
    - adding entries 133
  - phones
    - receiving faxes from 112, 139
  - phones, connecting extra 111
  - phones, downstream
    - sending faxes from 134
  - polling faxes 127
  - portrait orientation
    - changing (Mac) 75
    - selecting, Windows 59
  - ports
    - locating 6
  - postcards
    - output bin, selecting 23
  - power connection
    - locating 5, 6
  - power switch, locating 4
  - power-down delay
    - setting 152
  - prefixes, dial 117
  - presets (Mac) 73
  - print drivers
    - selecting 184
    - supported 40
  - print drivers (Mac)
    - changing settings 44
    - settings 73
  - print drivers (Windows)
    - changing settings 42
  - print job
    - canceling (Mac) 78
    - canceling (Windows) 72
  - print on both sides
    - Mac 74, 75
    - manually, Windows 53
    - Windows 53
  - print quality
    - improving 181
  - printing
    - from USB flash drives 82
    - product reports 11
    - settings (Mac) 73
    - printing on both sides
      - settings (Windows) 51
  - private receive 126
  - problem-solving
    - no response 197
    - slow response 198
  - protocol settings, fax 204
  - PS font list 11
  - pulse-dialing 118
- R**
- rear output bin
    - printing to 23
  - receiving faxes
    - answer mode, setting 122
    - autoreduction settings 125
    - blocking 123
    - error report, printing 204
    - from extension phone 112
    - polling 127
    - reprinting 138
    - reprinting faxes 125
    - ring patterns, settings 124
    - rings-to-answer settings 123
    - stamp-received setting 126
    - when you hear fax tones 139
  - recycling supplies 35
  - redialing
    - automatically, settings 118
  - reducing documents
    - copying 93
  - replacing printing cartridges 36
  - reports
    - configuration report 11
    - demo page 11
    - menu structure 11
    - network summary 11
    - PCL font list 11
    - PCL6 font list 11
    - print quality page 11
    - PS font list 11
    - service page 11
    - supplies status 11
    - usage page 11
  - Reports menu 11
  - reports, fax
    - error 204
    - printing all 203
  - reprinting faxes 125, 138
  - resize documents
    - copying 93
    - Mac 76
    - Windows 67
  - resolution
    - fax 119
  - restoring factory-set defaults 161
  - ring patterns 124
  - ring tones
    - distinctive 124
  - rings-to-answer setting 123
  - rough paper
    - output bin, selecting 23
- S**
- scale documents
    - Mac 76
    - Windows 67
  - scaling documents
    - copying 93
  - scanner
    - glass cleaning 186, 190, 193
  - scanning
    - from HP Scan software (Mac) 101
    - from HP Scan software (Windows) 100
    - to email, setup 103

- to network folder, setup 103
  - TWAIN-compliant software 107
  - WIA-compliant software 107
  - sending faxes
    - billing codes 120
    - canceling 128
    - confirmation 134
    - delaying 135
    - error report, printing 204
    - forwarding 122
    - from downstream telephone 134
    - from software 133
  - service page 11
  - settings
    - driver presets (Mac) 73
    - drivers 42
    - drivers (Mac) 44
    - factory-set defaults, restoring 161
    - network report 11
  - setup
    - scan to email and network folder 103
  - shortcuts (Windows)
    - creating 48
    - using 46
  - size, copy
    - reducing or enlarging 93
  - sizes, media
    - Fit to Page setting, faxing 125
  - sleep delay
    - disabling 152
    - enabling 152
  - small documents
    - copying 89
  - small paper
    - output bin, selecting 23
  - software
    - HP Utility 150
    - problems 227
    - scanning from TWAIN or WIA 107
    - sending faxes 133
    - uninstalling for Mac 232
    - uninstalling for Windows 231
  - solve
    - fax problems 205
  - solve problems
    - fax 217
  - solving
    - walk-up USB printing problems 199
  - special paper
    - printing (Windows) 61
  - special paper for covers
    - printing (Mac) 76
  - speed dials
    - programming 133
  - speed-dial entries
    - creating 115
    - deleting 116
    - editing 115
  - status
    - Home screen, control panel 9
    - HP Utility, Mac 150
    - supplies, printing report 11
  - storing
    - toner cartridges 35
  - straight-through paper path 23
  - subnet mask 145
  - supplies
    - counterfeit 28
    - low threshold settings 29
    - non-HP 27, 35
    - ordering 26
    - part numbers 31
    - recycling 35
    - replacing toner cartridges 36
    - status, viewing with HP Utility for Mac 150
    - using when low 29
  - supplies status page 11
  - supported paper 14
- T**
- TCP/IP
    - manually configuring IPv4 parameters 145
  - telephones
    - receiving faxes from 112, 139
  - telephones, connecting extra 111
  - telephones, downstream
    - sending faxes from 134
  - tone-dialing 118
  - toner cartridge
    - low threshold settings 29
    - using when low 29
  - toner cartridges
    - loading 34
    - non-HP 27, 35
    - order numbers 35
    - recycling 35
    - replacing 36
    - storage 35
    - supplies status page 11
  - top output bin
    - printing to 23
  - transparencies
    - output bin 23
    - printing (Windows) 61
  - Tray 1
    - jams 170
    - loading 18
  - tray 1
    - capacity 17
  - Tray 2
    - jams 173
    - loading 21
  - tray 2
    - capacity 20
  - trays
    - included 2
    - locating 4
    - part numbers 33
  - troubleshooting
    - checklist 158
    - fax error-correction setting 204
    - faxes 201
    - jams 164
    - Mac problems 229
    - network problems 221
    - paper feed problems 163
    - receive fax 211
    - send fax 205
    - USB connection 220
    - walk-up USB printing problems 199
    - Windows problems 227
    - wired network 221
    - wireless network 223
  - TWAIN-compliant software, scanning from 107
  - two-sided copying 91, 92
  - two-sided printing
    - settings (Windows) 51

## U

- unblocking fax numbers 123
- uninstalling Mac software 232
- uninstalling Windows software 231
- universal print driver 40
- usage page 11
- USB connection
  - troubleshooting 220
- USB flash drives
  - printing from 82

## V

- V.34 setting 204
- VoIP
  - faxing 130
- volume, adjusting 126

## W

- walk-up USB printing 82
- watermarks
  - printing (Mac) 77
  - printing (Windows) 71
- Web Services
  - applications 144
  - enabling 144
- Web sites
  - fraud reports 28
  - HP Web Jetadmin,
    - downloading 151
    - universal print driver 40
- WIA-compliant software, scanning from 107
- Windows
  - driver settings 42
  - faxing from 133
  - scanning from TWAIN or WIA software 107
  - universal print driver 40
- Windows print drivers
  - supported 40
- wireless network
  - troubleshooting 223
- wireless network interference 226
- wireless printing
  - solving problems 158
- Word, faxing from 134





A8P80-91069

