



Before using this machine for the first time, read this Quick Setup Guide to setup and install your machine. To view the Quick Setup Guide in other languages, please visit <http://solutions.brother.com/>.



**Note**

Not all models are available in all countries.

 WARNING	WARNING indicates a potentially hazardous situation which, if not avoided, could result in death or serious injuries.
 CAUTION	CAUTION indicates a potentially hazardous situation which, if not avoided, may result in minor or moderate injuries.

1

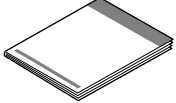
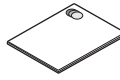
Unpack the machine and check the components

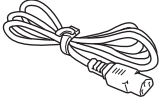
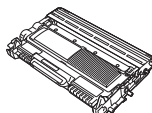
	 Quick Setup Guide	 Safety and Legal Booklet	 Documentation/ Installation CD-ROM(s)
	 AC Power Cord	 Drum Unit and Toner Cartridge Assembly (pre_installed)	

WARNING

- Plastic bags are used in the packaging of your machine. Plastic bags are not toys. To avoid danger of suffocation, please keep these bags away from babies and children and dispose of them properly.

**Note**

- Keep a minimum gap around the machine as shown in the illustration.

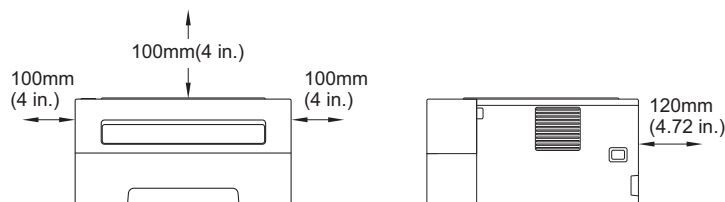

- We recommend that you save the original packaging.
- The components included in the box may differ depending on your country.
- If for any reason you must ship your machine, carefully repack the machine in the original packaging to avoid any damage during transit. The machine should be adequately insured with the carrier. How to repack the machine, see *Packing and shipping the machine* in the *User's Guide*.
- The illustrations in this guide show the HL-2270DW.
- The interface cable is not a standard accessory. Buy the appropriate interface cable for the interface you want to use (USB or Network).

USB cable

It is recommended to use a USB 2.0 cable (Type A/B) that is no more than 2 meters (6 feet) long.

Network cable

Use a straight-through Category5 (or greater) twisted-pair cable for 10BASE-T or 100BASE-TX Fast Ethernet Network.

2 Remove the packing material from the machine

! IMPORTANT

DO NOT connect the AC power cord yet.

- a** Remove the packing tape from the outside of the machine and the silica gel pack from the face-down output tray.

! CAUTION

DO NOT eat the Silica Pack. Please discard. If ingested seek medical attention immediately.

- b** Open the front cover.

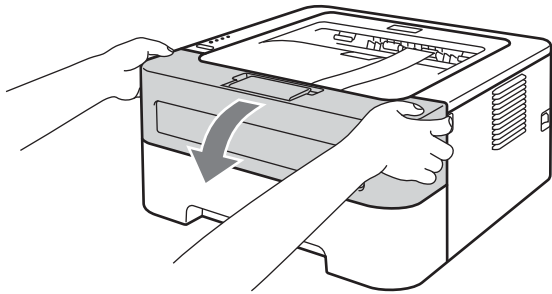

- c** Lift the elastic band off the drum.

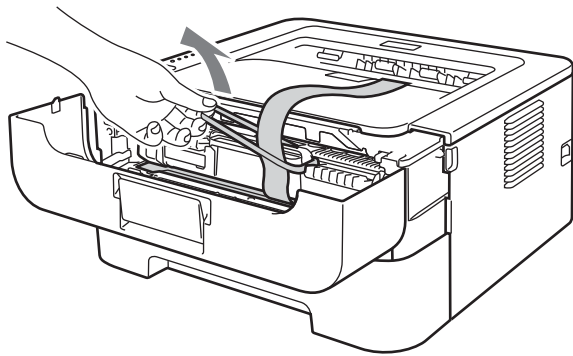

- d** Pull the paper strip to remove the protective material as shown in the illustration.

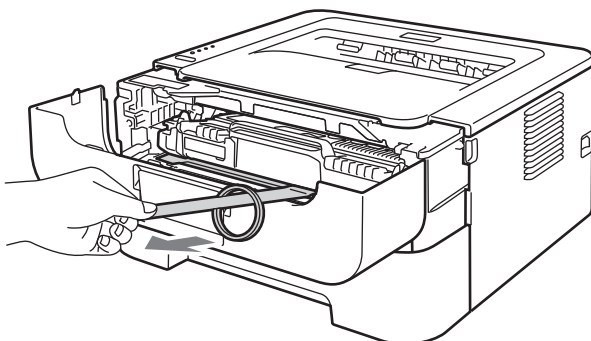

- e** Take out the drum unit and toner cartridge assembly.

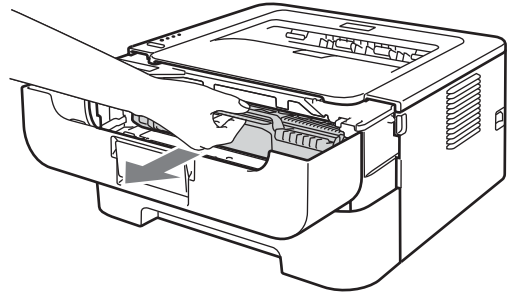

- f** Gently shake it from side to side several times to distribute the toner evenly inside the assembly.

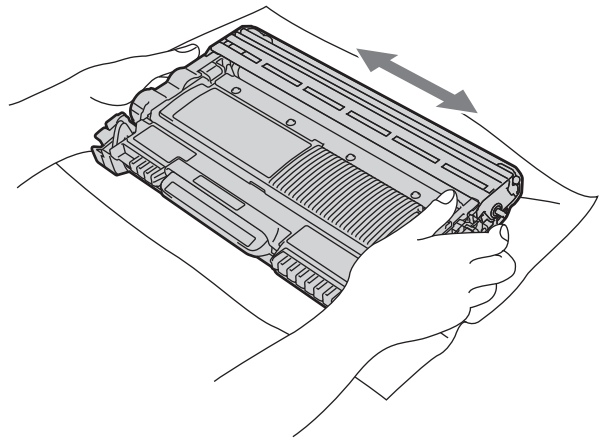

- g** Put the drum unit and toner cartridge assembly back in the machine.

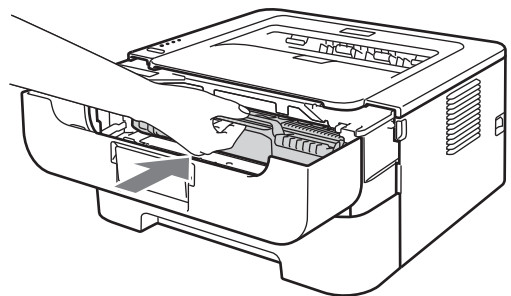

- h** Close the front cover of the machine.

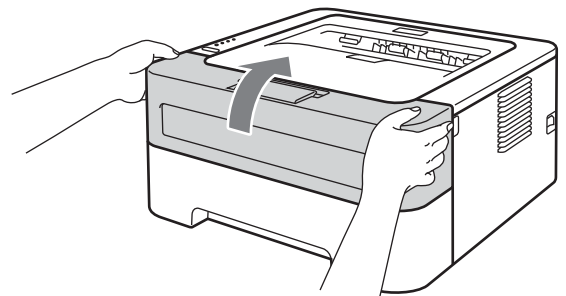

3 Load paper in the paper tray

a Pull the paper tray completely out of the machine.

b While pressing the green paper-guide release lever, slide the paper guides to fit the paper size you are loading in the tray. Make sure that the guides are firmly in the slots.

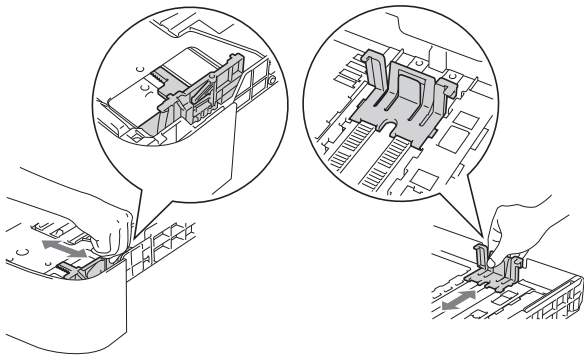

Note

For Legal or Folio size paper, press the release button in the bottom of the paper tray and then pull out the back of the paper tray.

(Legal or Folio size paper are not available in some regions.)

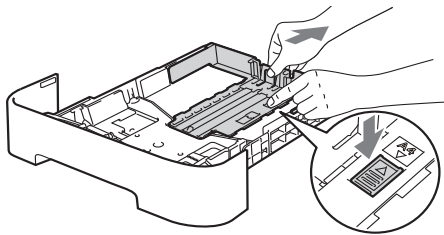

c Fan the stack of paper well to avoid paper jams and misfeeds.

d Put paper in the tray and make sure:

- The paper is below the maximum paper mark (▼▼▼).
- Over filling the paper tray will cause paper jams.
- The side to be printed on must be face down.
- The paper guides touch the sides of the paper so it will feed properly.

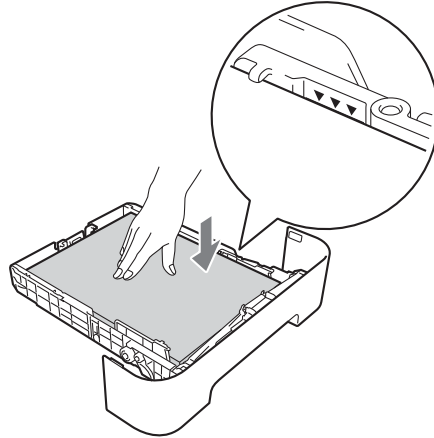

e Put the paper tray firmly back in the machine. Make sure that it is completely inserted into the machine.



For more information about recommended paper, See *Recommended paper and print media* in the *User's Guide*.

4

Print a test page

! IMPORTANT

DO NOT connect the interface cable yet.



- a** Connect the AC power cord to the machine and then connect it to an AC power outlet.
- b** Turn on the machine power switch.

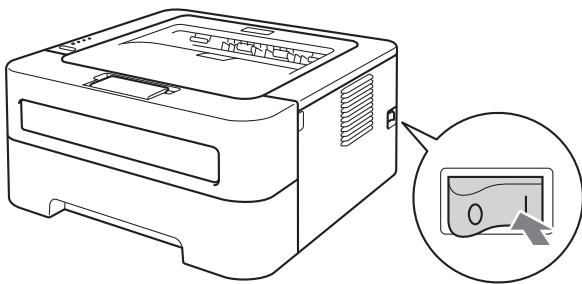

- c** After the machine has finished warming up, the **Ready** LED stops blinking and stays green.
- d** Press **Go**. The machine will print a test page. Check that the test page has printed correctly.

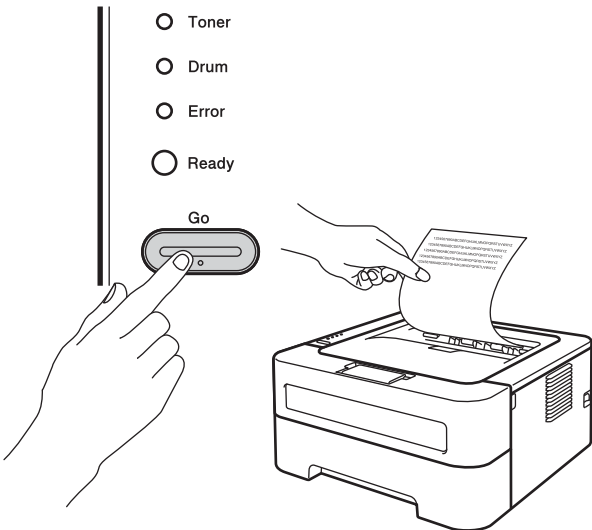

Note

This function will not be available after the first print job you send from your computer.

5

Choose your connection type

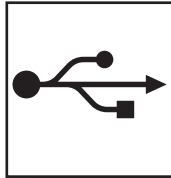
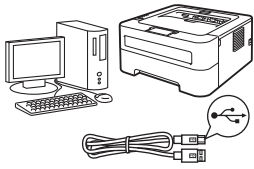

For USB Interface Users

Windows[®], go to page 6
Macintosh, go to page 7

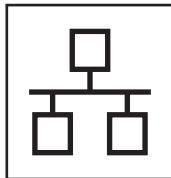
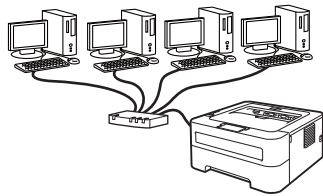

For Wired Network (HL-2270DW only)

Windows[®], go to page 8, 10
Macintosh, go to page 12

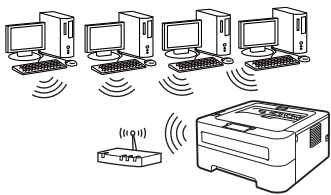

For Wireless Network

Windows[®] and Macintosh,
go to page 14



Note

You can download the latest drivers and utilities for your machine from the Brother Solutions Center at <http://solutions.brother.com/>.

USB	Windows [®]
	Macintosh
Wired Network	Windows [®]
	Macintosh
Wireless Network	Windows [®]
	Macintosh



For USB Interface Cable Users for Windows®

6 Before you install

! IMPORTANT

- If there are any programs running, close them.
- The screens may differ depending on your operating system.

- a** Make sure that your computer is ON and you are logged on with Administrator rights.
- b** Turn off the machine and make sure the USB interface cable is **NOT** connected to the machine, and then begin installing the printer driver. If you have already connected the cable, disconnect it.

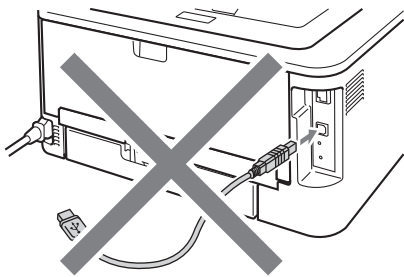

7 Install the printer driver

- a** Put the installation CD-ROM into your CD-ROM drive. If prompted, select your model and language.

Note

If the Brother screen does not appear automatically, go to **My Computer (Computer)**, double-click the CD-ROM icon, and then double-click **start.exe**.

- b** Click **Install Printer Driver**, and click **Yes** if you accept the license agreement.



Note

For Windows Vista® and Windows® 7 users, when the **User Account Control** screen appears, click **Allow** or **Yes**.

- c** Follow the on-screen instructions until this screen appears.



- d** Connect the USB cable to the USB connector on the machine marked with the  symbol, and then connect the cable to your computer.

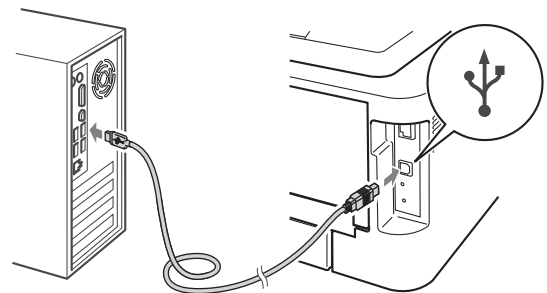

- e** Turn the machine on, and follow the on-screen instructions to complete setup.

Finish

The installation is now complete.

Note

- Depending on your security settings, a Windows Security or antivirus software window may appear when using the machine or its software. Please allow or permit the window to continue.
- **XML Paper Specification Printer Driver**
The XML Paper Specification Printer Driver is the most suitable driver when printing from the applications that use the XML Paper Specification documents. Please download the latest driver by accessing the Brother Solutions Center at <http://solutions.brother.com/>.



For USB Interface Cable Users for Macintosh

6 Before you install

! IMPORTANT

- For the latest drivers and information on the Mac OS X you are using, visit <http://solutions.brother.com/>.
- For Mac OS X 10.4.0 to 10.4.10 users, upgrade to Mac OS X 10.4.11 - 10.6.x.

- Make sure your machine is plugged in and your Macintosh is switched ON. You must be logged on with Administrator rights.
- Connect the USB cable to the USB connector on the machine marked with the  symbol, and then connect the cable to your Macintosh.

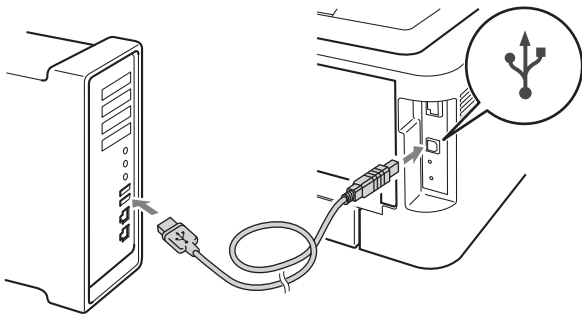

! IMPORTANT

- **DO NOT** connect the printer to a USB port on a keyboard or a non-powered USB hub.
- Connect the printer directly to your computer.

- Make sure the machine power switch is on.

7 Install the printer driver

- Put the installation CD-ROM into your CD-ROM drive.
- Double-click the **Start Here OSX** icon. Follow the on-screen instructions.



Note

It may take a few minutes for installation to complete.

- Follow the on-screen instructions until this screen appears. Choose your machine from the list, and then click **OK**.

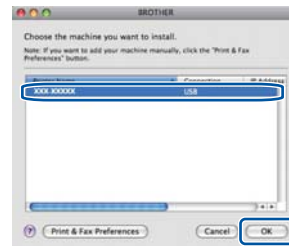

- When this screen appears, click **Next**.

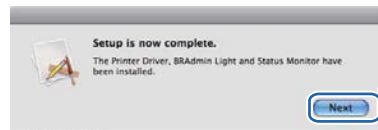

Note

When the **Brother Support** screen appears, make your selection and follow the on-screen instructions.

Finish

The installation is now complete.

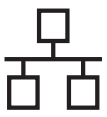

For Wired Network Cable Users for Windows® (For Peer-to-Peer network users) (HL-2270DW only)

6

Before you install

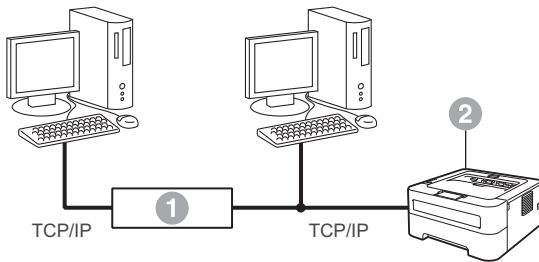

- ① Router
- ② Machine



Note

If you are going to connect the machine to your network, we recommend that you contact your system administrator prior to installation.

- a** Make sure that your computer is ON and you are logged on with Administrator rights.

! IMPORTANT

- If there are any programs running, close them.
- The screens may differ depending on your operating system.

- b** Remove the protective cap from the LAN connector.

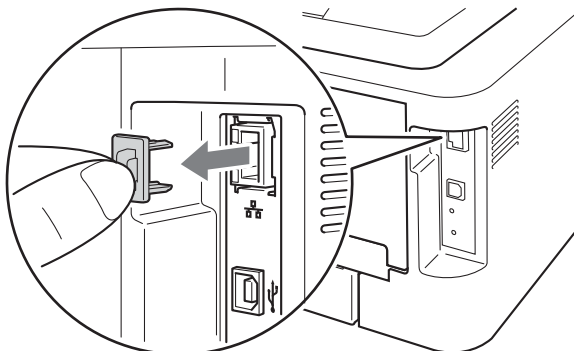

- c** Connect the network cable to the LAN connector marked with a  symbol and then connect it to a free port on your hub.

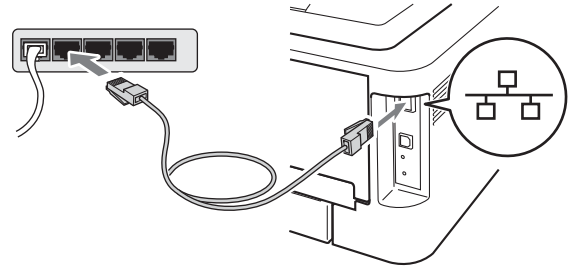

- d** Make sure the machine power switch is on.

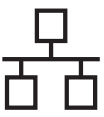

7 Install the printer driver

- a** Put the installation CD-ROM into your CD-ROM drive. If prompted, select your model and language.

Note

If the Brother screen does not appear automatically, go to **My Computer (Computer)**, double-click the CD-ROM icon, and then double-click **start.exe**.

- b** Click **Install Printer Driver**, and click **Yes** if you accept the license agreement.



Note

For Windows Vista® and Windows® 7 users, when the **User Account Control** screen appears, click **Allow** or **Yes**.

- c** Follow the on-screen instructions to complete setup.

Note

You can find your machine's IP Address and the node name by printing out the Printer Settings Page. See *Print the Printer Settings Page* on page 31.

Finish

The installation is now complete.

Note

- If you use a specified IP Address for the machine, you must set the Boot Method to Static by using the BRAdmin Light. For more information, See *Changing your machine's network settings* in the *Network User's Guide*.
- Depending on your security settings, a Windows Security or antivirus software window may appear when using the machine or its software. Please allow or permit the window to continue.
- **XML Paper Specification Printer Driver**
The XML Paper Specification Printer Driver is the most suitable driver when printing from the applications that use the XML Paper Specification documents. Please download the latest driver by accessing the Brother Solutions Center at <http://solutions.brother.com/>.

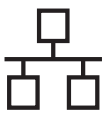

For Wired Network Cable Users for Windows® (For shared network users) (HL-2270DW only)

6 Before you install

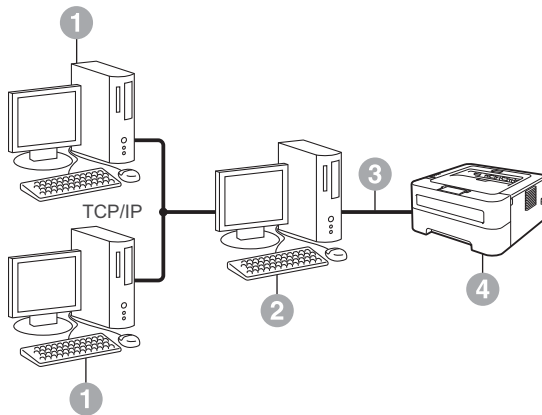

- 1 Client computer
- 2 Also known as "Server" or "Print server"
- 3 TCP/IP or USB
- 4 Machine

Note

If you are going to connect the machine to your network, we recommend that you contact your system administrator prior to installation.

- a** Make sure that your computer is ON and you are logged on with Administrator rights.

IMPORTANT

- If there are any programs running, close them.
- The screens may differ depending on your operating system.

- b** Make sure the machine power switch is on.

7 Install the printer driver

- a** Put the installation CD-ROM into your CD-ROM drive. If prompted, select your model and language.

Note

If the Brother screen does not appear automatically, go to **My Computer (Computer)**, double-click the CD-ROM icon, and then double-click **start.exe**.

- b** Click **Install Printer Driver**, and click **Yes** if you accept the license agreement.



Note

For Windows Vista® and Windows® 7 users, when the **User Account Control** screen appears, click **Allow** or **Yes**.

- c** Follow the on-screen instructions until this screen appears. Choose your machine's queue, and then click **OK**.

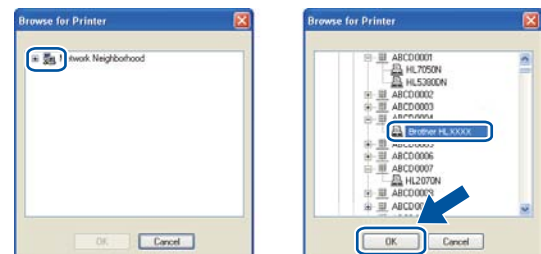

Note

Contact your administrator if you do not know the location or the name of the machine queue on the network.



- d** Follow the on-screen instructions to complete setup.

Finish

The installation is now complete.



Note

- Depending on your security settings, a Windows Security or antivirus software window may appear when using the machine or its software. Please allow or permit the window to continue.
- **XML Paper Specification Printer Driver**
The XML Paper Specification Printer Driver is the most suitable driver when printing from the applications that use the XML Paper Specification documents. Please download the latest driver by accessing the Brother Solutions Center at <http://solutions.brother.com/>.

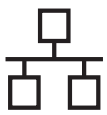

For Wired Network Cable Users for Macintosh (HL-2270DW only)

6

Before you install

! IMPORTANT

- For the latest drivers and information on the Mac OS X you are using, visit <http://solutions.brother.com/>.
- For Mac OS X 10.4.0 to 10.4.10 users, upgrade to Mac OS X 10.4.11 - 10.6.x.

- a Make sure your machine is plugged in and your Macintosh is switched ON. You must be logged on with Administrator rights.
- b Remove the protective cap from the LAN connector.

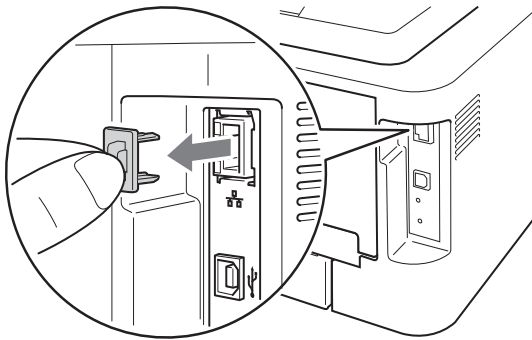

- c Connect the network cable to the LAN connector marked with a  symbol and then connect it to a free port on your hub.

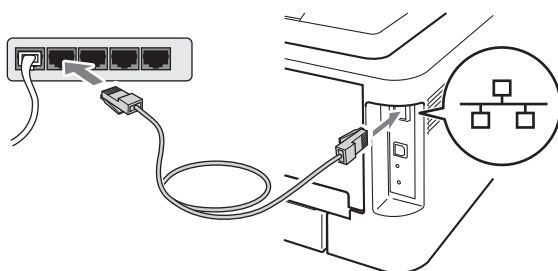

- d Make sure the machine power switch is on.

7

Install the printer driver

- a Put the installation CD-ROM into your CD-ROM drive.
- b Double-click the **Start Here OSX** icon. Follow the on-screen instructions.



Note

It may take a few minutes for installation to complete.

- c Follow the on-screen instructions until this screen appears. Choose your machine from the list, and then click **OK**.



Note

- If there is more than one of the same model connected on your network, the MAC Address (Ethernet Address) will be displayed after the model name.
- You can find your machine's MAC Address (Ethernet Address) and IP Address by printing out the Printer Settings Page. See *Print the Printer Settings Page* on page 31.

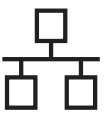

d When this screen appears, click **Next**.

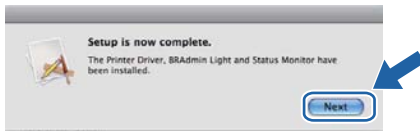

 **Note**

When the **Brother Support** screen appears, make your selection and follow the on-screen instructions.

Finish

The installation is now complete.

 **Note**

If you use a specified IP Address for the machine, you must set the Boot Method to Static by using the BRAdmin Light. For more information, See *Changing your machine's network settings* in the *Network User's Guide*.



For Wireless Network Interface Users

6

Before you begin

First you must configure the wireless network settings of your machine to communicate with your network access point/router. After the machine is configured to communicate with your access point/router, computers on your network will have access to the machine. To use the machine from these computers, you will need to install the printer driver. The following steps will guide you through the configuration and installation process.

! IMPORTANT

- If you are going to connect the machine to your network, we recommend that you contact your system administrator prior to installation. You must know your wireless network settings before you proceed with this installation.
- If you have previously configured the wireless settings of the machine, you must reset the print server back to its factory default settings.
 1. Turn off the machine.
 2. Make sure that the front cover is closed and the power cord is plugged in.
 3. Hold down Go as you turn on the power switch. Keep Go pressed down until all the LEDs light up and then Ready LED turns off.
 4. Release Go. Make sure that all the LEDs turn off.
 5. Press Go six times. Make sure that all the LEDs light up to indicate the print server has been reset to its factory default settings. The machine will restart.



Note

- To achieve optimum results with normal everyday document printing, place the Brother machine as close to the network access point/router as possible with minimal obstructions. Large objects and walls between the two devices as well as interference from other electronic devices can affect the data transfer speed of your documents.

Due to these factors, wireless may not be the best method of connection for all types of documents and applications. If you are printing large files, such as multi-page documents with mixed text and large graphics, you may want to consider choosing wired Ethernet for a faster data transfer or USB for the fastest throughput speed.
- Although the Brother HL-2270DW can be used in both a wired and wireless network, only one of the connection methods can be used at a time.
- The screens are based on HL-2270DW.

Infrastructure Mode

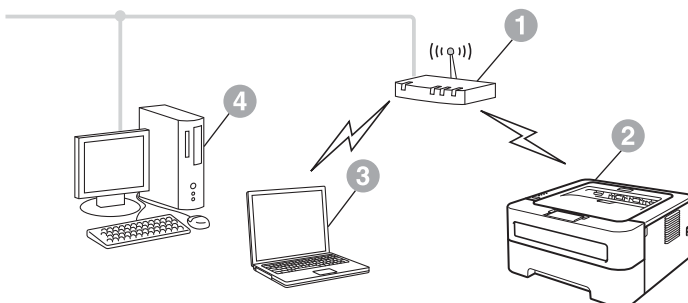

- 1 Access point/router
- 2 Wireless Network machine (your machine)
- 3 Wireless capable computer connected to the access point/router
- 4 Wired computer connected to the access point/router



7 Confirm your network environment (Infrastructure Mode)

The following instructions will offer two methods for installing your Brother machine in a wireless network environment.

Note

To setup your machine in any other wireless environment, you can find instructions in the *Network User's Guide*.

- a** If your WLAN access point/router does not support Wi-Fi Protected Setup or AOSS™, **write down the wireless network settings** of your WLAN access point/router.

! IMPORTANT

Please do not contact Brother Customer Service for assistance without the wireless security information. We cannot assist you in locating your Network Security Settings.

SSID (Network Name)	Network Key (Security Key/Encryption Key)

For example:

SSID (Network Name)	Network Key (Security Key/Encryption Key)
HELLO	12345678

Note

If you do not know this information (SSID (Network Name) and Network Key (Security Key/Encryption Key)) you cannot continue the wireless setup.

How can I find this information (SSID (Network Name) and Network Key (Security Key/Encryption Key))

- 1) You should see the documentation provided with your WLAN access point/router.
- 2) The initial network name could be the manufacturer's name or the model name.
- 3) If you do not know the security information, please consult the router manufacturer, your system administrator or internet provider.

Now go to

For Windows® Users go to page 18
For Macintosh Users go to page 24

- b** If your WLAN access point/router supports automatic wireless mode (Wi-Fi Protected Setup or AOSS™)

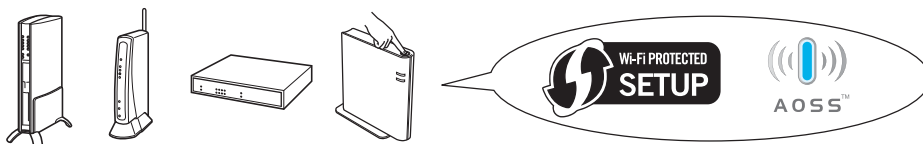

Now go to

For Windows® Users go to page 16
For Macintosh Users go to page 22



Configuration using the automatic wireless (one-push) method

8 Configure the wireless settings and install the printer driver

a Confirm your WLAN access point/router has the Wi-Fi Protected Setup or AOSS™ symbol as shown below.



Note

If your WLAN access point/router supports Wi-Fi Protected Setup (PIN Method) and you want to configure your machine using the PIN (Personal Identification Number) Method, See *Using the PIN Method of Wi-Fi Protected Setup in the Network User's Guide.*

b Place the Brother machine within range of your Wi-Fi Protected Setup or AOSS™ access point/router. The range may differ depending on your environment. Refer to the instructions provided with your access point/router.

c Put the installation CD-ROM into your CD-ROM drive. If prompted, select your model and language.

Note

If the Brother screen does not appear automatically, go to **My Computer (Computer)**, double-click the CD-ROM icon, and then double-click **start.exe**.

d Click **Install Printer Driver**, and click **Yes** if you accept the license agreement.



e Click **Wireless Network Connection** and click **Next**.



Note

For Windows Vista® and Windows® 7 users, when the **User Account Control** screen appears, click **Allow** or **Yes**.

f Choose **Brother Peer-to-Peer Network Printer**, and then click **Next**.

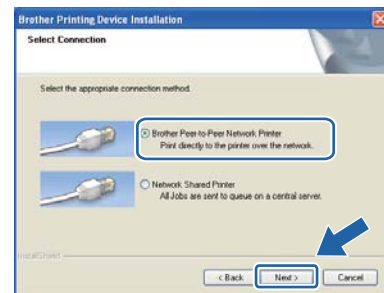

Note

Choose the option of the Firewall setting, and then click **Next**.

g Choose **Yes, my Access Point supports WPS or AOSS and I want to use them** and click **Next**.





h Press the wireless setup button located at the back of the machine for less than 2 seconds as shown in the illustration below.

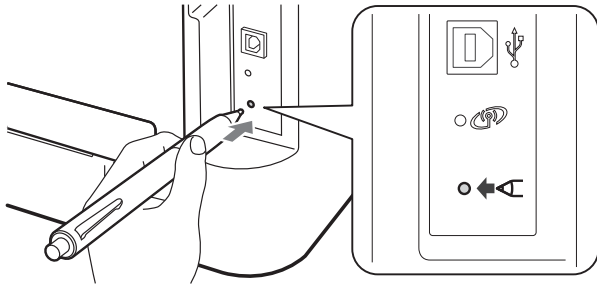

Note

- Use a pointy object such as a ballpoint pen to press the button.
- Do not press the button for 3 seconds or more, since the machine will change to the PIN Method of the Wi-Fi Protected Setup mode.

i This feature will automatically detect which mode (Wi-Fi Protected Setup or AOSS™) your access point/router uses to configure your machine for 2 minutes.

j Push the Wi-Fi Protected Setup or AOSS™ button on your WLAN access point/router. See the user's guide for your WLAN access point/router for instructions.



k The machine LED's will indicate the connection results. See *LED indications when using the one-push wireless setting mode* on page 33.

A WLAN report will automatically be printed. If the connection failed, check the error on the printed report and refer to *Troubleshooting* on page 28

Click **Next**.

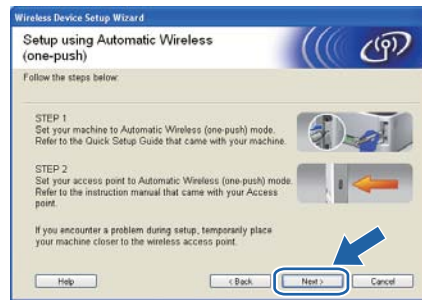

m Check the box after you confirm that you have completed the wireless settings, and then click **Next**.

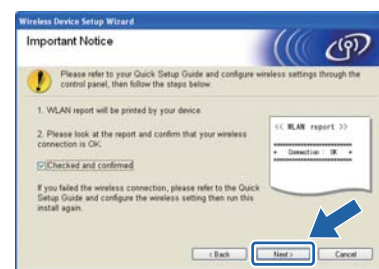

Install the printer driver

! IMPORTANT

DO NOT try to cancel any of the screens during this installation.

n Follow the on-screen instructions to complete setup.

Finish

The installation is now complete.

Note

- If you use a specified IP Address for the machine, you must set the Boot Method to Static by using the BRAdmin Light. For more information, See *Changing your machine's network settings* in the *Network User's Guide*.
- Depending on your security settings, a Windows Security or antivirus software window may appear when using the machine or its software. Please allow or permit the window to continue.
- **XML Paper Specification Printer Driver**
The XML Paper Specification Printer Driver is the most suitable driver when printing from the applications that use the XML Paper Specification documents. Please download the latest driver by accessing the Brother Solutions Center at <http://solutions.brother.com/>.



Configuration in Infrastructure mode, temporarily using a USB or Ethernet (LAN) cable

8 Configure the wireless settings and install the printer driver

! IMPORTANT

- You need to temporarily use a USB cable or Ethernet cable (HL-2270DW only) during configuration (cable not included).
- You must have the wireless settings you wrote down for your network in step 7 on page 15 before you proceed.

a Put the installation CD-ROM into your CD-ROM drive. If prompted, select your model and language.

Note

If the Brother screen does not appear automatically, go to **My Computer (Computer)**, double-click the CD-ROM icon, and then double-click **start.exe**.

b Click **Install Printer Driver**, and click **Yes** if you accept the license agreement.



c Choose **Wireless Network Connection** and then click **Next**.



Note

For Windows Vista® and Windows® 7 users, when the **User Account Control** screen appears, click **Allow** or **Yes**.

d Choose **Brother Peer-to-Peer Network Printer**, and then click **Next**.

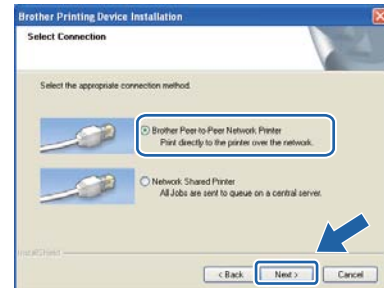

Note

Choose the option of the Firewall setting, and then click **Next**.

e Choose **No**, and then click **Next**.



f Read the **Important Notice**. Check the box after you confirm the SSID and Network Key, and then click **Next**.



g For USB cable users, go to **h**. (HL-2270DW only) For Ethernet cable users, go to **j**.



h Choose **Temporarily use a USB cable (Recommended)** and then click **Next**.

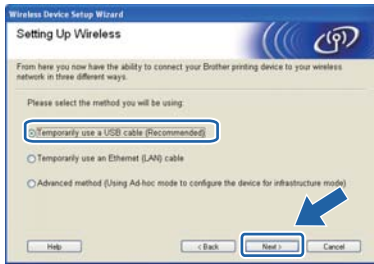

i Temporarily connect the USB cable (not included) directly to the computer and the machine.

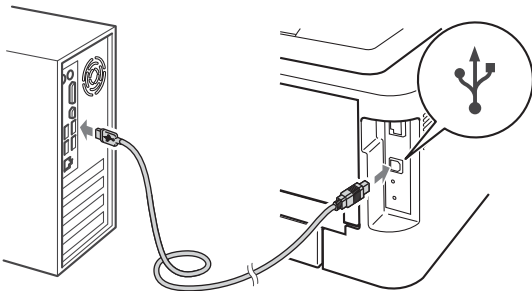

Go to Step **n**.

j Choose **Temporarily use an Ethernet (LAN) cable** and then click **Next**.

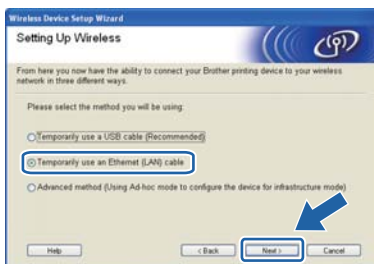

k Remove the protective cap from the LAN connector.

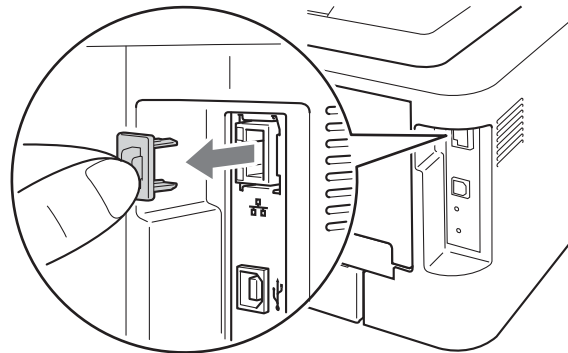

l Temporarily connect the Brother wireless device to your access point using a network cable (not included) and click **Next**.

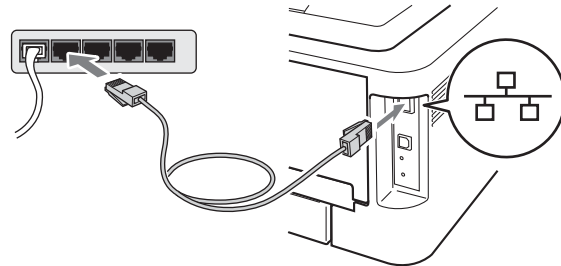

m Choose the machine you wish to configure, and click **Next**. If the list is blank, check if the access point and the machine are powered on, and then click **Refresh**.



Note

The default Node name is "BRNxxxxxxxxxxxx".



n If the confirmation screen appears, check the box and click **Next**. When the following screen appears, check **Yes** if you want to connect with the listed SSID. Click **Next** and go to **r**.

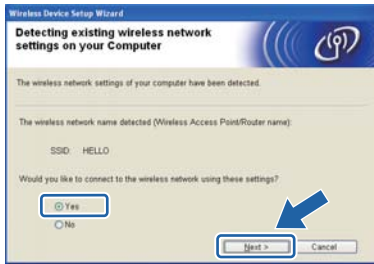

o The wizard will search for wireless networks available from your machine. Choose the SSID that your checked in advance on page 15), and then click **Next**.

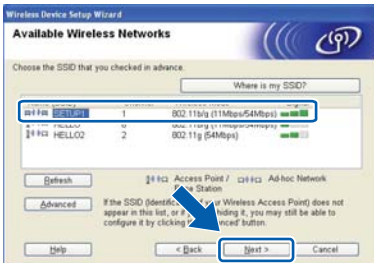

Note

- If the list is blank, check that the access point has power and is broadcasting the SSID, and then see if the machine and the access point are within range for wireless communication. Then, click **Refresh**.
- If your access point is set to not broadcast the SSID you can manually add it by clicking the **Advanced** button. Follow the on-screen instructions for entering the **Name (SSID)**, and then click **Next**.



p If your network is not configured for Authentication and Encryption, the following screen will appear. To continue configuration, click **OK** and go to **r**.



q Enter the **Network Key** and then enter the key again in **Confirm Network Key**, then click **Next**.

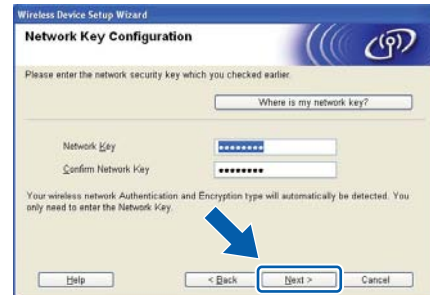

r Click **Next**. The settings will be sent to your machine.

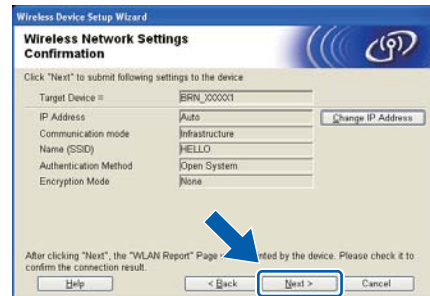

Note

- The settings will remain unchanged if you click **Cancel**.
- If you want to manually enter the IP address settings of your machine, click **Change IP Address** and enter the necessary IP address settings for your network.
- (For USB cable users) If the wireless setup failure screen appears, click **Retry** and try starting from step **o** again.

s For USB cable users, go to **w**.
(HL-2270DW only) For Ethernet cable users, go to **t**.



t A wireless LAN report will automatically be printed.

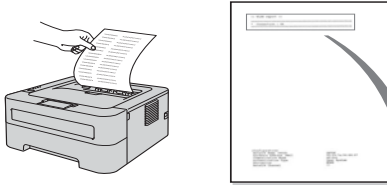

```
<< WLAN report >>
*****
* Connection : OK
*****
```

u Choose the status as it is shown for the Connection on the wireless LAN report. Click **Next**. If your status is "Connection:OK", go to step **w**. If your status is "Connection:Failed", go to step **v**.

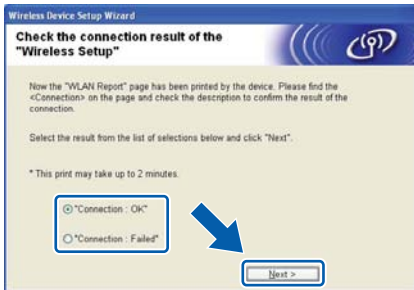

v Click **Finish**. Wireless setup failed as it was unable to associate with a wireless network. Check the error code on the printed wireless LAN report and refer to *Troubleshooting* on page 28. Then try starting from step **b** again.

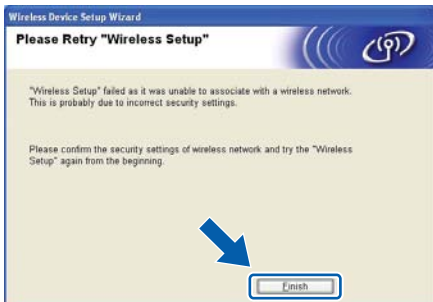

w (For USB cable users)
Disconnect the USB cable between the computer and the machine.



(For LAN cable users)
Disconnect the network cable between your access point and the machine, and click **Next**.



Wireless setup is completed.

Install the printer driver

x Follow the on-screen instructions to complete setup.

Finish

The installation is now complete.

Note

- If you use a specified IP Address for the machine, you must set the Boot Method to Static by using the BRAdmin Light. For more information, See *Changing your machine's network settings* in the *Network User's Guide*.
- Depending on your security settings, a Windows Security or antivirus software window may appear when using the machine or its software. Please allow or permit the window to continue.
- **XML Paper Specification Printer Driver**
The XML Paper Specification Printer Driver is the most suitable driver when printing from the applications that use the XML Paper Specification documents. Please download the latest driver by accessing the Brother Solutions Center at <http://solutions.brother.com/>.



Configuration using the automatic wireless (one-push) method

8 Configure the wireless settings and install the printer driver

a Confirm your WLAN access point/router has the Wi-Fi Protected Setup or AOSS™ symbol as shown below.



Note

If your WLAN access point/router supports Wi-Fi Protected Setup (PIN Method) and you want to configure your machine using the PIN (Personal Identification Number) Method, See *Using the PIN Method of Wi-Fi Protected Setup in the Network User's Guide*.

b Place the Brother machine within range of your Wi-Fi Protected Setup or AOSS™ access point/router. The range may differ depending on your environment. Refer to the instructions provided with your access point/router.

c Turn on your Macintosh. Put the installation CD-ROM into your CD-ROM drive.

d Double-click the **Start Here OSX** icon. Follow the on-screen instructions.



e Click **Wireless Network Connection** and click **Next**.



f Choose **Yes, my Access Point supports WPS or AOSS™ and I want to use them**, and then click **Next**.



g Press the wireless setup button located at the back of the machine for less than 2 seconds as shown in the illustration below.

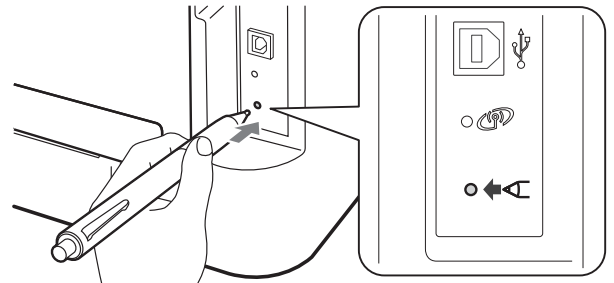

Note

- Use a pointy object such as a ballpoint pen to press the button.
- Do not press the button for 3 seconds or more, since the printer will change to the PIN Method of the Wi-Fi Protected Setup mode.

h This feature will automatically detect which mode (Wi-Fi Protected Setup or AOSS™) your access point/router uses to configure your machine for 2 minutes.

i Push the Wi-Fi Protected Setup or AOSS™ button on your WLAN access point/router. See the user's guide for your WLAN access point/router for instructions.

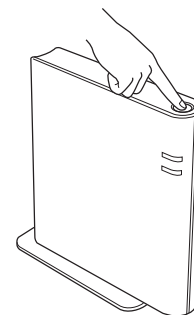



j The machine LED's will indicate the connection results. See *LED indications when using the one-push wireless setting mode* on page 33.

A WLAN report will automatically be printed. If the connection failed, check the error on the printed report and refer to *Troubleshooting* on page 28

k Click **Next**.



Check the box after you confirm that you have completed the wireless settings, and then click **Next**.



Install the printer driver

! IMPORTANT

DO NOT try to cancel any of the screens during this installation.

Note

- If there is more than one of the same model connected on your network, the MAC Address (Ethernet Address) will be displayed after the model name. You can also confirm your IP Address by scrolling to the right.
- You can find your machine's MAC Address (Ethernet Address) and the IP Address by printing out the Printer Settings Page. See *Print the Printer Settings Page* on page 31.

m Follow the on-screen instructions to complete setup.

Note

When the **Brother Support** screen appears, make your selection and follow the on-screen instructions.

Finish

The installation is now complete.

Note

If you use a specified IP Address for the machine, you must set the Boot Method to Static by using the BRAdmin Light. For more information, See *Changing your machine's network settings* in the *Network User's Guide*.



Configuration in Infrastructure mode, temporarily using a USB or Ethernet (LAN) cable

8 Configure the wireless settings and install the printer driver

IMPORTANT

- You need to temporarily use a USB cable or Ethernet cable (HL-2270DW only) during configuration (cable not include).
- You must have the wireless settings you wrote down for your network in step 7 on page 15 before you proceed.

a Turn on your Macintosh. Put the installation CD-ROM into your CD-ROM drive.

b Double-click the **Start Here OSX** icon. Follow the on-screen instructions.



c Click **Wireless Network Connection** and click **Next**.



d Choose **No**, and then click **Next**.



e Read the **Important Notice**. Check the box after you confirm the SSID and Network Key, and then click **Next**.



f For USB cable users, go to **g**. (HL-2270DW only) For Ethernet cable users, go to **i**.

g Choose **Temporarily use a USB cable (Recommended)** and then click **Next**.



h Temporarily connect the USB cable (not included) directly to the computer and the machine.

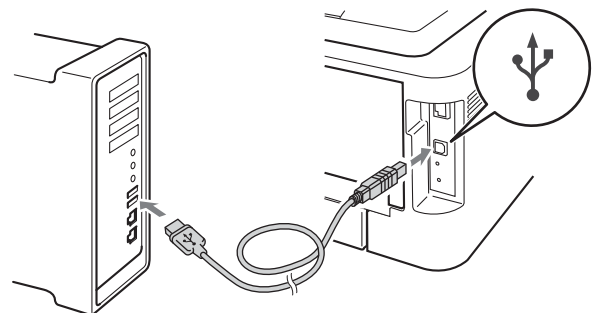

Go to Step **m**.



i Choose **Temporarily use a Ethernet (LAN) cable** and then click **Next**.



j Remove the protective cap from the LAN connector.

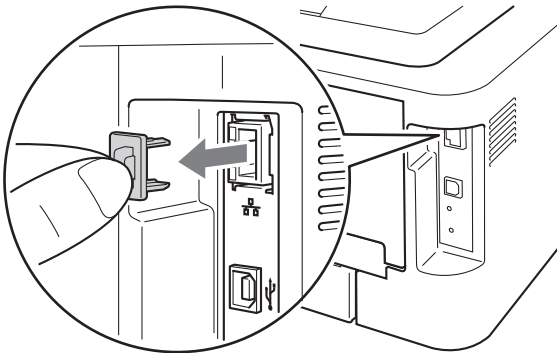

k Temporarily connect the Brother wireless device to your access point using a network cable (not included) and click **Next**.

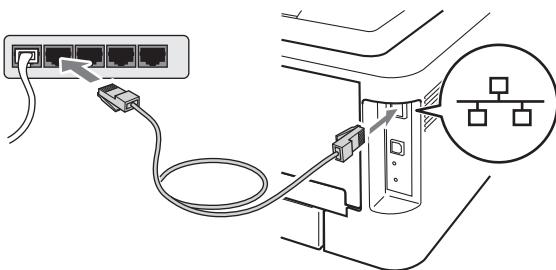

l Choose the machine you wish to configure, and click **Next**. If the list is blank, check if the access point and the machine are powered on, and then click **Refresh**.



Note

- The default node name is "BRNxxxxxxxxxxxx".
- You can find your machine's MAC Address (Ethernet Address) by printing out the Printer Settings Page. See *Print the Printer Settings Page* on page 31.

m The wizard will search for wireless networks available from your machine. Choose the access point you wish to associate the machine with, and then click **Next**.



Note

- If the list is blank, check that the access point has power and is broadcasting the SSID, and then see if the machine and the access point are within range for wireless communication. Then, click **Refresh**.
- If your access point is set to not broadcast the SSID you can manually add it by clicking the **Advanced** button. Follow the on-screen instructions for entering the **Name (SSID)**, and then click **Next**.





n If your network is not configured for Authentication and Encryption, the following screen will appear. To continue configuration, click **OK** and go to **p**.



o Enter the **Network Key** and then enter the key again in **Confirm Network Key**, then click **Next**.



p Click **Next**. The settings will be sent to your machine.



Note

- The settings will remain unchanged if you click **Cancel**.
- If you want to manually enter the IP address settings of your machine, click **Change IP Address** and enter the necessary IP address settings for your network.
- (For USB cable users) If the wireless setup failure screen appears, click **Retry** and try starting from step **m** again.

q For USB cable users, go to **u**. (HL-2270DW only) For Ethernet cable users, go to **r**.

r A wireless LAN report will automatically be printed.

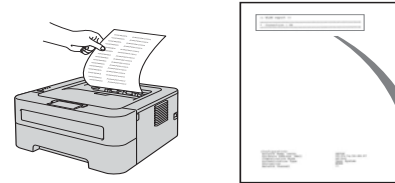

s Choose the status as it is shown for the Connection on the wireless LAN report. Click **Next**. If your status is "**Connection:OK**", go to step **u**. If your status is "**Connection:Failed**", go to step **t**.



t Click **Finish**. Wireless setup failed as it was unable to associate with a wireless network. Check the error code on the printed wireless LAN report and refer to *Troubleshooting* on page 28. Then try starting from step **b** again.





- U** (For USB cable users)
Disconnect the USB cable between the computer and the machine.



- (For LAN cable users)
Disconnect the network cable between your access point and the machine, and click **Next**.



Wireless setup is completed.

Install the printer driver

! IMPORTANT

DO NOT try to cancel any of the screens during this installation.

Note

- If there is more than one of the same model connected on your network, the MAC Address (Ethernet Address) will be displayed after the model name. You can also confirm your IP Address by scrolling to the right.
- You can find your machine's MAC Address (Ethernet Address) and the IP Address by printing out the Printer Settings Page. See *Print the Printer Settings Page* on page 31.

- V** Follow the on-screen instructions to complete setup.

Note

When the **Brother Support** screen appears, make your selection and follow the on-screen instructions.

Finish

The installation is now complete.

Note

If you use a specified IP Address for the machine, you must set the Boot Method to Static by using the BRAdmin Light. For more information, See *Changing your machine's network settings* in the *Network User's Guide*.



Troubleshooting

! IMPORTANT

Please do not contact Brother Customer Service for assistance without the wireless security information. We cannot assist you in locating your network security settings.

How can I find the wireless settings SSID and Network Key

- 1) You should see the documentation provided with your WLAN access point/router.
- 2) The initial network name could be the manufacturer's name or the model name.
- 3) If you do not know the security information, please consult the router manufacturer, your system administrator or internet provider.

* The Network Key may also be described as the Password, Security Key or Encryption Key.

WLAN report

Press **Go** five times within four seconds. The machine prints the WLAN report.

If the WLAN report that printed shows that the connection failed, check the error code on the printed report and refer to the following instructions.

Error code	Recommended Solutions
TS-01	<p>The wireless setting is not activated, turn the wireless setting to ON.</p> <ul style="list-style-type: none"> - If a LAN cable is connected to your machine, disconnect it and turn the wireless setting of your machine to ON. <p>Hold down Go for 10 seconds. Release Go when the machine prints a Network Configuration page that indicates the current network settings.</p>
TS-02	<p>The WLAN access point/router cannot be detected.</p> <ol style="list-style-type: none"> 1. Check the following 4 points. <ul style="list-style-type: none"> - Make sure that the WLAN access point/router is powered on. - Move your machine to an obstruction-free area, or closer to the WLAN access point/router. - Temporarily place your machine within about one meter (3.3 feet) from the WLAN access point when you are configuring the wireless settings. - If your WLAN access point/router is using MAC address filtering, confirm the MAC address of the Brother machine is allowed in the filter. 2. If you manually entered the SSID and security information (SSID/authentication method/encryption method/Network Key) the information may be incorrect. Reconfirm the SSID and security information and reenter the correct information as necessary. <p>See <i>How can I find the wireless settings SSID and Network Key</i> on page 28 to confirm.</p>



Error code	Recommended Solutions												
TS-04	<p>The Authentication/Encryption methods used by the selected WLAN access point/router are not supported by your machine.</p> <p>For infrastructure mode, change the authentication and encryption methods of the WLAN access point/router. Your machine supports the following authentication methods WPA, WPA2, OPEN and Shared key. WPA supports TKIP or AES encryption methods. WPA2 supports AES for the encryption method. OPEN and Shared key correspond to WEP encryption.</p> <p>If your problem is not solved the SSID or network settings you entered may be incorrect. Reconfirm the wireless network settings.</p> <p>Combined table of authentication and encryption methods</p> <table border="1" data-bbox="328 669 1090 969"> <thead> <tr> <th data-bbox="328 669 710 712">Authentication method</th> <th data-bbox="710 669 1090 712">Encryption method</th> </tr> </thead> <tbody> <tr> <td data-bbox="328 712 710 797" rowspan="2">WPA-Personal</td> <td data-bbox="710 712 1090 754">TKIP</td> </tr> <tr> <td data-bbox="710 754 1090 797">AES</td> </tr> <tr> <td data-bbox="328 797 710 840">WPA2-Personal</td> <td data-bbox="710 797 1090 840">AES</td> </tr> <tr> <td data-bbox="328 840 710 925" rowspan="2">OPEN</td> <td data-bbox="710 840 1090 882">WEP</td> </tr> <tr> <td data-bbox="710 882 1090 925">NONE (without encryption)</td> </tr> <tr> <td data-bbox="328 925 710 969">Shared key</td> <td data-bbox="710 925 1090 969">WEP</td> </tr> </tbody> </table> <p>See <i>How can I find the wireless settings SSID and Network Key</i> on page 28 to confirm.</p> <p>For ad-hoc mode, change the authentication and encryption methods of your computer for the wireless setting. Your machine supports OPEN authentication method only, with optional WEP encryption.</p>	Authentication method	Encryption method	WPA-Personal	TKIP	AES	WPA2-Personal	AES	OPEN	WEP	NONE (without encryption)	Shared key	WEP
Authentication method	Encryption method												
WPA-Personal	TKIP												
	AES												
WPA2-Personal	AES												
OPEN	WEP												
	NONE (without encryption)												
Shared key	WEP												
TS-05	<p>The security information (SSID/Network Key) is incorrect. Reconfirm the SSID and security information (Network Key). If your router uses WEP encryption, enter the key used as the first WEP key. Your Brother machine supports the use of the first WEP key only.</p> <p>See <i>How can I find the wireless settings SSID and Network Key</i> on page 28 to confirm.</p>												
TS-06	<p>The wireless security information (Authentication method/Encryption method/Network Key) is incorrect. Reconfirm the wireless security information (Authentication method/Encryption method/Network Key) in the table of TS-04. If your router uses WEP encryption, enter the key used as the first WEP key. Your Brother machine supports the use of the first WEP key only.</p> <p>See <i>How can I find the wireless settings SSID and Network Key</i> on page 28 to confirm.</p>												



Error code	Recommended Solutions
TS-07	<p>The machine cannot detect a WLAN access point/router that has WPS or AOSS™ enabled.</p> <p>If you would like to configure your wireless settings using WPS or AOSS™, you must operate both your machine and the WLAN access point/router.</p> <p>Confirm your WLAN access point/router supports WPS or AOSS™ and try starting again.</p>  <p>If you do not know how to operate your WLAN access point/router using WPS or AOSS™, See the documentation provided with your WLAN access point/router, ask the manufacturer of your WLAN access point/router or ask your network administrator.</p>
TS-08	<p>Two or more WLAN access points that have WPS or AOSS™ enabled are detected.</p> <ul style="list-style-type: none">- Confirm that only one WLAN access point/router within range has the WPS or AOSS™ method active and try again.- Try starting again after a few minutes in order to avoid interference from other access points.

Web Based Management (web browser)

The Brother print server is equipped with a web server that allows you to monitor its status or change some of its configuration settings, using HTTP (Hyper Text Transfer Protocol).

Note

- The login name for the Administrator is '**admin**' (case sensitive) and the default password is '**access**'.
- We recommend Microsoft® Internet Explorer® 6.0 (or greater) or Firefox 3.0 (or greater) for Windows® and Safari 3.0 (or greater) for Macintosh. Please also make sure that JavaScript and Cookies are always enabled in whichever browser you use. To use a web browser, you will need to know the IP Address of the print server. The IP Address of the print server is listed on the Print Setting Page.

- a Open your browser.
- b Type `http://machine_ip_address/` into your browser (Where `machine_ip_address` is the IP address or the print server name).
 - For example `http://192.168.1.2/`



See *Web Based Management* in the *Network User's Guide*.

Reset the network settings to the factory default

You can reset the print server back to its default factory settings (resetting all information such as the password and IP address information).

- a Turn off the machine.
- b Make sure that the front cover is closed and the power cord is plugged in.
- c Hold down **Go** as you turn on the power switch. Keep **Go** pressed down until all the LEDs light up and then **Ready** LED turns off.
- d Release **Go**. Make sure that all the LEDs turn off.
- e Press **Go** six times. Make sure that all the LEDs light up to indicate the print server has been reset to its factory default settings. The machine will restart.

Print the Printer Settings Page







The Printer Settings Page lists all the current printer settings, including network settings.





















- a Make sure that the front cover is closed and the power cord is plugged in.
- b Turn on the machine and wait until the machine is in the Ready state.
- c Press **Go** three times within 2 seconds. The machine will print the current printer settings page.



Note





















If the **IP address** on the Printer Settings Page shows **0.0.0.0**, wait for one minute and try again.

Printer LED Indications

Blinking:  or  or  ON:  or  or  OFF: 

Printer LED	OFF	SLEEP DEEP SLEEP	WARMING UP COOLING DOWN ¹	READY	RECEIVING DATA DATA REMAINING ²
Toner					
Drum					
Error					
Ready		 Dimmed			

Printer LED	TONER LOW ³	REPLACE TONER ⁴	TONER ENDED	DRUM END SOON ³	REPLACE DRUM
Toner					
Drum					
Error					
Ready					
 User's Guide	Chapter 4	Chapter 4	Chapter 4	Chapter 4	Chapter 4

Printer LED	COVER OPEN PAPER JAM ²	NO PAPER	DRUM ERROR ²	DRUM STOP	Service call error ²
Toner					
Drum					
Error					
Ready					
 User's Guide	Chapter 5	Chapter 5	Chapter 4	Chapter 4	Chapter 3

¹ The LED will blink ON and OFF at 1 second intervals.





























² The LED will blink ON and OFF at 0.5 second intervals.

³ The yellow LED will blink in a pattern of ON for 2 seconds and then OFF for 3 seconds.

⁴ You can change the toner setting to the continue mode. Press **Go** seven times (all the LED flashes twice, and then the **Ready** LED is on). The machine continues printing until the LED indicates the toner ended message.

Other Information

LED indications when using the one-push wireless setting mode

LEDs	Setting WLAN ¹	Connecting WPS/AOSS™ ¹	Connected ²	Connection fail ³	No Access Point ³	Connection error ⁴		
Toner								
Drum								
Error								
Ready								

¹ The LED will blink (turn on for 0.2 seconds and off for 0.1 second).

² The LED will turn on for 5 minutes.

³ For 30 Seconds the LED will blink ON and OFF at 0.1 second intervals.

⁴ The LED will flash 10 times and then turn OFF for half a second. This pattern will repeat 20 times.

Brother CreativeCenter



Get inspired. If you're using Windows, double-click the Brother CreativeCenter icon on your desktop to access our FREE web site with many ideas and resources for personal and professional use.



Mac users can access Brother CreativeCenter at this web address:

<http://www.brother.com/creativecenter/>

Consumables

When the time comes to replace consumable items, an error will be indicated by the LED's on the control panel. For more information about the consumables for your machine, visit us at <http://solutions.brother.com/> or contact your local Brother reseller.

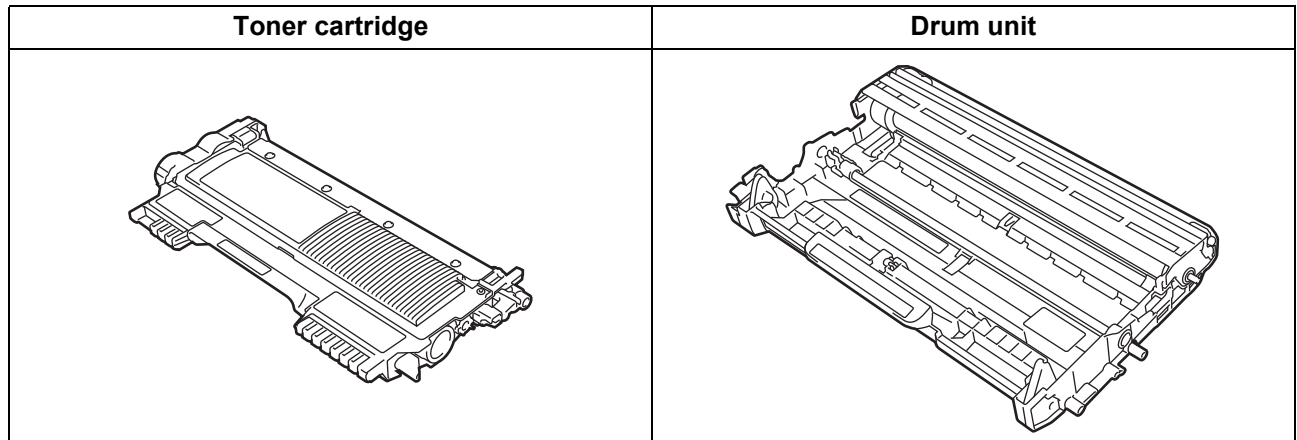

For replacing the consumable items, See *Replacing consumable items* in the *User's Guide*.

Trademarks

The Brother logo is a registered trademark of Brother Industries, Ltd.

Brother is a registered trademark of Brother Industries, Ltd.

Microsoft, Windows, Windows Server and Internet Explorer are either registered trademarks or trademarks of Microsoft Corporation in the United States and/or other countries.

Windows Vista is either a registered trademark or trademark of Microsoft Corporation in the United States and/or other countries.

Apple, Macintosh, Safari and Mac OS are trademarks of Apple Inc., registered in the U.S. and other countries.

Wi-Fi and Wi-Fi Alliance are registered trademarks of the Wi-Fi Alliance.

AOSS is a trademark of Buffalo Inc.

Each company whose software title is mentioned in this manual has a Software License Agreement specific to its proprietary programs.

Any trade names and product names of companies appearing on Brother products, related documents and any other materials are all trademarks or registered trademarks of those respective companies.

Compilation and Publication

Under the supervision of Brother Industries, Ltd., this manual has been compiled and published, covering the latest product descriptions and specifications.

The contents of this manual and the specifications of this product are subject to change without notice.

Brother reserves the right to make changes without notice in the specifications and materials contained herein and shall not be responsible for any damages (including consequential) caused by reliance on the materials presented, including but not limited to typographical and other errors relating to the publication.

Copyright and License

©2010 Brother Industries, Ltd. All rights reserved.

This product includes software developed by the following vendors:

©1983-1998 PACIFIC SOFTWARES, INC. ALL RIGHTS RESERVED.

©2010 Devicescape Software, Inc. All rights reserved.

This product includes the "KASAGO TCP/IP" software developed by ZUKEN ELMIC, Inc.