

SHARP

PN-HS551

PN-HS501

PN-HS431

PN-HY551

PN-HY501

PN-HY431

LCD MONITOR

OPERATION MANUAL

HDMI™

IMPORTANT:

To aid reporting in case of loss or theft, please record the product's model and serial numbers in the space provided. The numbers are located in the rear of the product.





Model No.:

Serial No.:

U.S.A. ONLY

IMPORTANT INFORMATION

WARNING: TO REDUCE THE RISK OF FIRE OR ELECTRIC SHOCK, DO NOT EXPOSE THIS PRODUCT TO RAIN OR MOISTURE.

 <table border="1"><tr><td>CAUTION</td></tr><tr><td>RISK OF ELECTRIC SHOCK DO NOT OPEN</td></tr></table> 	CAUTION	RISK OF ELECTRIC SHOCK DO NOT OPEN	 <p>The lightning flash with arrowhead symbol, within a triangle, is intended to alert the user to the presence of uninsulated "dangerous voltage" within the product's enclosure that may be of sufficient magnitude to constitute a risk of electric shock to persons.</p>
CAUTION			
RISK OF ELECTRIC SHOCK DO NOT OPEN			
<p>CAUTION: TO REDUCE THE RISK OF ELECTRIC SHOCK, DO NOT REMOVE COVER. NO USER-SERVICEABLE PARTS INSIDE. REFER SERVICING TO QUALIFIED SERVICE PERSONNEL.</p>	 <p>The exclamation point within a triangle is intended to alert the user to the presence of important operating and maintenance (servicing) instructions in the literature accompanying the product.</p>		

WARNING:
FCC Regulations state that any unauthorized changes or modifications to this equipment not expressly approved by the manufacturer could void the user's authority to operate this equipment.

NOTE:
This equipment has been tested and found to comply with the limits for a Class A digital device, pursuant to Part 15 of the FCC Rules. These limits are designed to provide reasonable protection against harmful interference when the equipment is operated in a commercial environment. This equipment generates, uses, and can radiate radio frequency energy and, if not installed and used in accordance with the instruction manual, may cause harmful interference to radio communications. Operation of this equipment in a residential area is likely to cause harmful interference in which case the user will be required to correct the interference at his own expense.

U.S.A. ONLY

To maintain compliance with EMC regulations, use shielded cables to connect to the following terminals: HDMI input terminal, D-sub input terminal and RS-232C input terminal.

DEAR SHARP CUSTOMER

Thank you for your purchase of a SHARP LCD product. To ensure safety and many years of trouble-free operation of your product, please read the Safety Precautions carefully before using this product.

SAFETY PRECAUTIONS

Electricity is used to perform many useful functions, but it can also cause personal injuries and property damage if improperly handled. This product has been engineered and manufactured with the highest priority on safety. However, improper use can result in electric shock and/or fire. In order to prevent potential danger, please observe the following instructions when installing, operating and cleaning the product. To ensure your safety and prolong the service life of your LCD product, please read the following precautions carefully before using the product.

1. Read instructions — All operating instructions must be read and understood before the product is operated.
2. Keep this manual in a safe place — These safety and operating instructions must be kept in a safe place for future reference.
3. Observe warnings — All warnings on the product and in the instructions must be observed closely.
4. Follow instructions — All operating instructions must be followed.
5. Cleaning — Unplug the power cord from the power outlet before cleaning the product. Use a dry cloth to clean the product. Do not use liquid cleaners or aerosol cleaners. Do not use dirty cloths. Doing so may damage the product.
6. Attachments — Do not use attachments not recommended by the manufacturer. Use of inadequate attachments can result in accidents.
7. Water and moisture — Do not use the product near water. Do not install the product in a place where water may splash onto it. Be careful of equipment which drains water such as an air-conditioner.
8. Ventilation — The vents and other openings in the cabinet are designed for ventilation. Do not cover or block these vents and openings since insufficient ventilation can cause overheating and/or shorten the life of the product. Do not place the product on a sofa, rug or other similar surface, since they can block ventilation openings. Do not place the product in an enclosed place such as a bookcase or rack, unless proper ventilation is provided or the manufacturer's instructions are followed.
9. Power cord protection — The power cords must be routed properly to prevent people from stepping on them or objects from resting on them.
10. The LCD panel used in this product is made of glass. Therefore, it can break when the product is dropped or applied with impact. Be careful not to be injured by broken glass pieces in case the LCD panel breaks.
11. Overloading — Do not overload power outlets or extension cords. Overloading can cause fire or electric shock.
12. Entering of objects and liquids — Never insert an object into the product through vents or openings. High voltage flows in the product, and inserting an object can cause electric shock and/or short internal parts. For the same reason, do not spill water or liquid on the product.
13. Servicing — Do not attempt to service the product yourself. Removing covers can expose you to high voltage and other dangerous conditions. Request a qualified service person to perform servicing.
14. Repair — If any of the following conditions occurs, unplug the power cord from the power outlet, and request a qualified service person to perform repairs.
 - a. When the power cord or plug is damaged.
 - b. When a liquid was spilled on the product or when objects have fallen into the product.
 - c. When the product has been exposed to rain or water.
 - d. When the product does not operate properly as described in the operating instructions.

Do not touch the controls other than those described in the operating instructions. Improper adjustment of controls not described in the instructions can cause damage, which often requires extensive adjustment work by a qualified technician.
 - e. When the product has been dropped or damaged.
 - f. When the product displays an abnormal condition. Any noticeable abnormality in the product indicates that the product needs servicing.
15. Replacement parts — In case the product needs replacement parts, make sure that the service person uses replacement parts specified by the manufacturer, or those with the same characteristics and performance as the original parts. Use of unauthorized parts can result in fire, electric shock and/or other danger.
16. Safety checks — Upon completion of service or repair work, request the service technician to perform safety checks to ensure that the product is in proper operating condition.
17. Wall mounting — When mounting the product on a wall, be sure to install the product according to the method recommended by the manufacturer.
18. Heat sources — Keep the product away from heat sources such as radiators, heaters, stoves and other heat-generating products (including amplifiers).

SAFETY PRECAUTIONS (Continued)

19. Batteries — Incorrect use of batteries may cause the batteries to burst or ignite. A leaky battery may corrode the equipment, dirty your hands or spoil your clothing. In order to avoid these problems, make sure to observe the precautions below:
 - Use the specified batteries only.
 - Install the batteries with due attention to the plus (+) and minus (-) sides of the batteries according to the instructions in the compartment.
 - Do not mix old and new batteries.
 - Do not mix batteries of different types. Voltage specifications of batteries of the same shape may vary.
 - Replace an exhausted battery with a new one promptly.
 - If you will not use the remote control for a long time, remove the batteries.
 - If leaked battery fluid gets on your skin or clothing, rinse immediately and thoroughly. If it gets into your eye, bathe your eye well rather than rubbing and seek medical treatment immediately. Leaked battery fluid that gets into your eye or your clothing may cause a skin irritation or damage your eye.
20. Usage of the monitor must not be accompanied by fatal risks or dangers that, could lead directly to death, personal injury, severe physical damage or other loss, including nuclear reaction control in nuclear facility, medical life support system, and missile launch control in a weapon system.
21. Do not stay in contact with the parts of the product that become hot for long periods of time. Doing so may result in low-temperature burns.
22. Do not modify this product.

WARNING:

This is a Class A product. In a domestic environment this product may cause radio interference in which case the user may be required to take adequate measures.

An apparatus with CLASS I construction shall be connected to a MAIN socket outlet with a protective earthing connection.

STABILITY HAZARD

If a monitor is not positioned in a sufficiently stable location, it can be potentially hazardous due to falling. Many injuries, particularly to children, can be avoided by taking simple precautions such as:

- Using fixing devices like wall mount brackets recommended by the manufacturer.
- Only using furniture that can safely support the monitor.
- Ensuring the monitor is not overhanging the edge of the supporting furniture.
- Not placing the monitor on tall furniture (for example, cupboards or bookcases) without anchoring both the furniture and the monitor to a suitable support.
- Not standing the monitors on cloth or other materials placed between the monitor and supporting furniture.
- Educating children about the dangers of climbing on furniture to reach the monitor or its controls.
- This equipment is not suitable for use in locations where children are likely to be present unsupervised.

Especially for child safety

- Don't allow children to climb on or play with the monitor.
- Don't place the monitor on furniture that can easily be used as steps, such as a chest of drawers.
- Remember that children can become excited while watching a program, especially on a "larger than life" monitor. Care should be taken to place or install the monitor where it cannot be pushed, pulled over, or knocked down.
- Care should be taken to route all cords and cables connected to the monitor so that they cannot be pulled or grabbed by curious children.

TIPS AND SAFETY INSTRUCTIONS

- The TFT color LCD panel used in this monitor is made with the application of high precision technology. However, there may be minute points on the screen where pixels never light or are permanently lit. Also, if the screen is viewed from an acute angle there may be uneven colors or brightness. Please note that these are not malfunctions but common phenomena of LCDs and will not affect the performance of the monitor.
- Do not display a still picture for a long period, as this could cause a residual image.
- Never rub or tap the monitor with hard objects.
- Please understand that SHARP CORPORATION bears no responsibility for errors made during use by the customer or a third party, nor for any other malfunctions or damage to this product arising during use, except where indemnity liability is recognized under law.
- This monitor and its accessories may be upgraded without advance notice.
- Do not use the monitor where there is a lot of dust, where humidity is high, or where the monitor may come into contact with oil or steam. Do not use in an environment where there are corrosive gases (sulfur dioxide, hydrogen sulfide, nitrogen dioxide, chlorine, ammonia, ozone, etc.). As this could lead to fire.
- Ensure that the monitor does not come into contact with water or other fluids. Ensure that no objects such as paper clips or pins enter the monitor as this could lead to fire or electric shock.
- Do not place the monitor on top of unstable objects or in unsafe places. Do not allow the monitor to receive strong shocks or to strongly vibrate. Causing the monitor to fall or topple over may damage it.
- Do not use the monitor near heating equipment or in places where there is likelihood of high temperature, as this may lead to generation of excessive heat and outbreak of fire.
- Do not use the monitor in places where it may be exposed to direct sunlight. Risk of cabinet deformation and failure if the monitor is used in direct sunlight.
- If the monitor is installed in a location exposed to sunlight such as next to a window, measures to reduce ultraviolet and infrared radiation and temperature measures are required. For details, consult your dealer.
- Please be sure to constantly remove dust and garbage that has attached to the ventilation opening. If dust collects in the ventilation opening or the inside of the monitor, it may lead to excessive heat, outbreak of fire, or malfunction. Please request a cleaning of the inside of the monitor from an authorized SHARP servicing dealer or service center.
- Images cannot be rotated on this monitor. When using in portrait orientation, you will need to prepare appropriately orientated content in advance.
- The power outlet shall be installed near the equipment and shall be easily accessible.

The Power Cord

- Use only the power cord supplied with the monitor.
- Do not damage the power cord nor place heavy objects on it, stretch it or over bend it. Also, do not add extension cords. Damage to the cord may result in fire or electric shock.
- Do not use the power cord with a power tap. Adding an extension cord may lead to fire as a result of overheating.
- Do not remove or insert the power plug with wet hands. Doing so could result in electric shock.
- Unplug the power cord if it is not used for a long time.
- Do not attempt to repair the power cord if it is broken or malfunctioning. Refer the servicing to the service representative.

Manual Scope

- Microsoft and Windows are either registered trademarks or trademarks of Microsoft Corporation in the United States and/or other countries.
- The terms HDMI, HDMI High-Definition Multimedia Interface, and the HDMI Logo are trademarks or registered trademarks of HDMI Licensing Administrator, Inc.
- VESA is either registered trademark or trademark of Video Electronics Standards Association in the United States and/or other countries.
- All other brand and product names are trademarks or registered trademarks of their respective holders.
- This product comes with RICOH Bitmap Fonts produced and sold by RICOH COMPANY, LTD.
- Language of OSD menu used in this manual is English by way of example.
- Illustrations in this manual may not exactly represent the actual product or display.
- This manual assumes use in landscape orientation, except where specifically noted.

LED Backlight

- The LED backlight in this product has a limited lifetime.
 - * If the screen gets dark or does not turn on, it may be necessary to replace the LED backlight.
 - * This LED backlight is exclusive to this product and must be replaced by an authorized SHARP servicing dealer or service center. Please contact an authorized SHARP servicing dealer or service center for assistance.

MOUNTING PRECAUTIONS

- This product is for use indoors.
- A mounting bracket compliant with VESA specifications is required.
- Since the monitor is heavy, consult your dealer before installing, removing or moving the monitor.
- Mounting the monitor on the wall requires special expertise and the work must be performed by an authorized SHARP dealer. You should never attempt to perform any of this work yourself. Our company will bear no responsibility for accidents or injuries caused by improper mounting or mishandling.
- Use the monitor with the surface perpendicular to a level surface. If necessary, the monitor may be tilted up to 20 degrees upward or downward.
- This monitor should be used at an ambient temperature between 32°F (0°C) and 104°F (40°C). Provide enough space around the monitor to prevent heat from accumulating inside.

For the monitor in landscape orientation

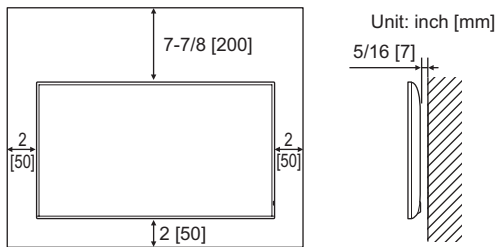

For the monitor in portrait orientation

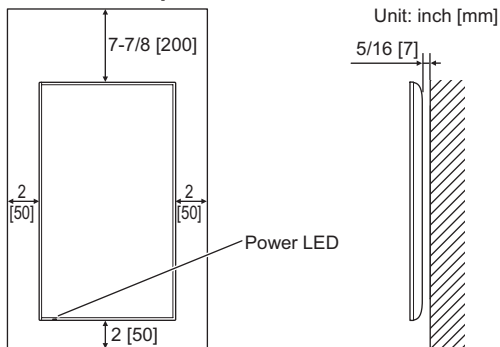

- If it is difficult to provide sufficient space for any reason such as the installation of the monitor inside a housing, or if the ambient temperature may be outside of the range of 32°F (0°C) to 104°F (40°C), install a fan or take other measures to keep the ambient temperature within the required range.
- Do not block any ventilation openings. If the temperature inside the monitor rises, this could lead to a malfunction.
- Do not place the monitor on a device which generates heat.

- Adhere to the following when installing the monitor in its portrait orientation. Failing to adhere to the following may cause malfunctions.
 - Install the monitor such that the power LED is located on the bottom side.
 - Set the THERMAL SENSOR SETTING in the SETUP menu to PORTRAIT. (See page 26.)
 - Be sure to clamp the power cord (supplied) by using the supplied cable clamp (affixing type). When clamping the power cord, take care not to stress the terminal of the power cord. Do not bend the power cord excessively.

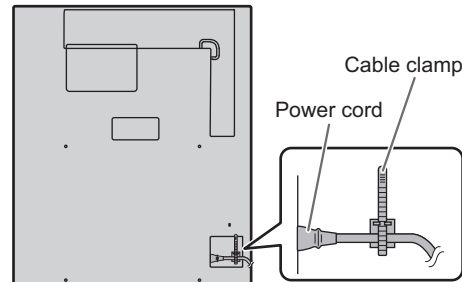

Mounting the monitor laying flat on a surface

- When using the monitor laying flat on a surface (when the monitor is tilted 20 degrees or more upward or downward from the perpendicular in relation to a level surface), consult an authorized SHARP dealer because there are some specific mounting conditions. Adhere to the following. Failing to adhere to the following may cause malfunctions.

- Set THERMAL SENSOR SETTING in the SETUP menu to FACE UP or FACE DOWN. (See page 26.)
- Use the monitor at the ambient temperature within the range of 32°F (0°C) to 86°F (30°C). Provide 7-7/8 inch (200 mm) or more space between the monitor and the ceiling or other mounting surfaces and surrounding objects to prevent heat from accumulating inside. If it is difficult to provide sufficient space or if the ambient temperature may be outside of the range of 32°F (0°C) to 86°F (30°C), install a fan or take other measures to keep the ambient temperature within the required range.

For the monitor laying flat on a surface (facing up)

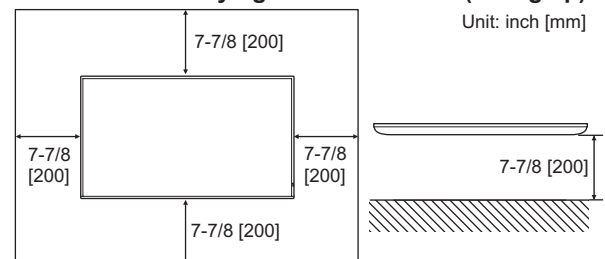

For the monitor laying flat on a surface (facing down)

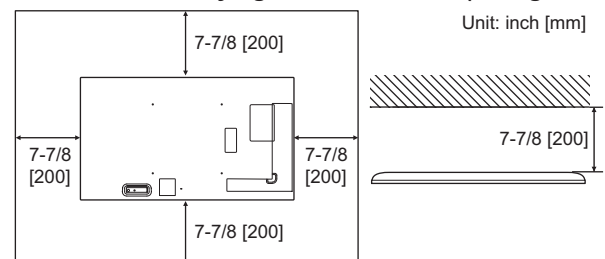

- Do not press hard on the LCD panel or otherwise subject it to impacts.

Contents

IMPORTANT INFORMATION	3	Menu Items	22
DEAR SHARP CUSTOMER	4	Displaying the menu screen.....	22
SAFETY PRECAUTIONS	4	Menu item details.....	23
TIPS AND SAFETY INSTRUCTIONS	6	Adjustments for computer screen display.....	27
MOUNTING PRECAUTIONS	7	Controlling the Monitor with a computer (RS-232C) ...	28
Supplied Components	8	Computer connection.....	28
Part Names	9	Communication conditions.....	28
Connecting Peripheral Equipment	10	Communication procedure.....	28
Connecting the Power Cord	12	RS-232C command table.....	29
Binding Cables	12	Controlling the Monitor with a computer (LAN).....	31
Attaching the USB flash drive cover	13	Command-based control.....	31
Attaching the logo sticker	13	Troubleshooting	32
Preparing the Remote Control Unit	14	Specifications	33
Installing the batteries.....	14	Mounting Precautions	
Remote control operation range.....	14	(For SHARP dealers and service engineers).....	37
Turning Power On/Off	15		
Turning on the main power.....	15		
Turning power on/off.....	15		
Basic Operation	17		
Using Media Player	20		
Playing files.....	20		
Operations during play.....	21		
Auto playback.....	21		
Playing files using the SCHEDULE function.....	21		

Supplied Components

If any component should be missing, please contact your dealer.

- Liquid Crystal Display Monitor: 1
- Remote control unit: 1
- Power cord: 1
- Remote control unit battery: 2
- Setup Manual: 1
- Cable clamp: 2
- Logo sticker: 1
- USB flash drive cover: 1
- USB flash drive cover fixing screw: 2

* For environmental protection!
Do not dispose of batteries in household waste. Follow the disposal instructions for your area.

Part Names

■ Front view

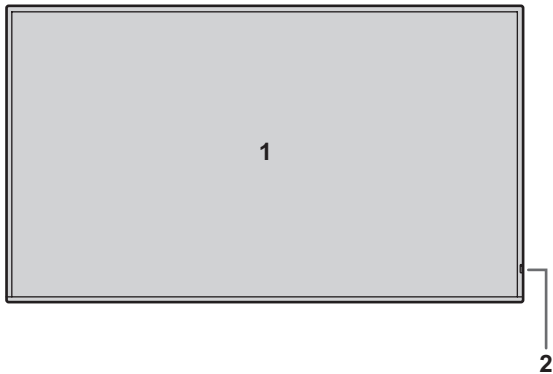

■ Rear view

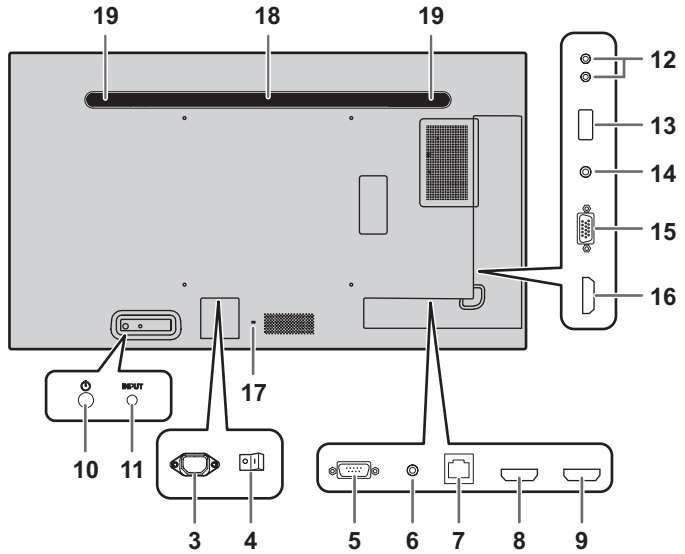

1. LCD panel
2. Power LED (See page 15.) / Remote control sensor (See page 14.)
3. AC input terminal (See page 12.)
4. Main power switch (See page 15.)
5. RS-232C input terminal (See page 11.)
6. IR output terminal (See page 11.)
7. LAN terminal (See page 11.)
8. HDMI3 input terminal (See page 10.)
9. HDMI2 input terminal (See page 10.)
10. POWER button (See page 15.)
11. INPUT button (See page 18.)

12. Audio output terminals (See page 10.)
13. USB port (See page 10.)
14. Audio input terminal (See page 10.)
15. D-sub input terminal (See page 10.)
16. HDMI1 input terminal (See page 10.)
17. Anti-theft slot (🔒)
Allows the monitor to be secured using a commercially available anti-theft lock.
18. Vents
19. Speakers

■ Remote control unit

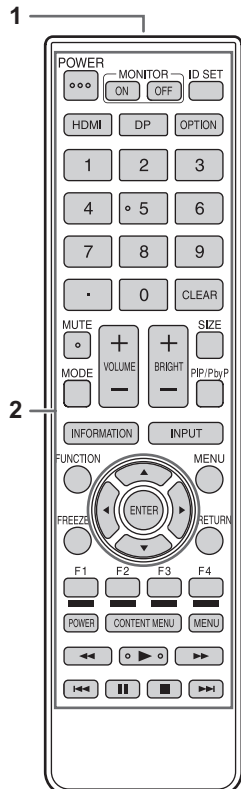

1. Signal transmitter
2. Operation buttons (See page 17.)

Connecting Peripheral Equipment

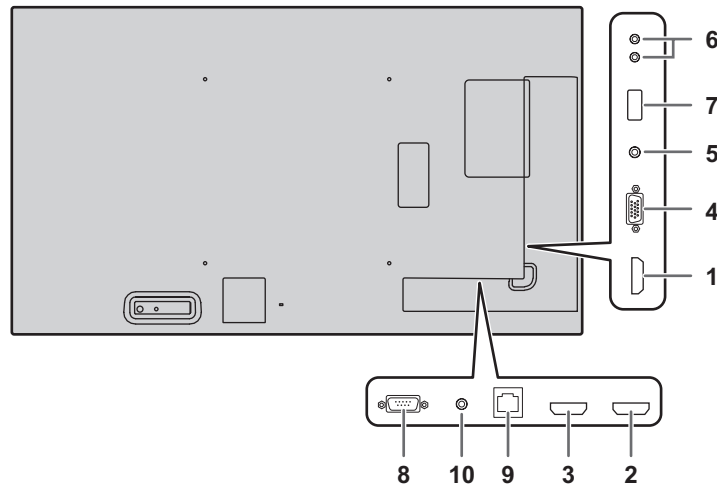

! Caution

- Be sure to turn off the main power switch and disconnect the plug from the power outlet before connecting/ disconnecting cables. Also, read the manual of the equipment to be connected.
- Be careful not to confuse the input terminal with the output terminal when connecting cables. Accidentally reversing cables connected to the input and output terminals may cause malfunctions and the other problems.
- Do not use any cable that has a damaged or deformed terminal. Using such cables may cause malfunctions.

TIPS

- Images may not be displayed properly depending on the computer (video card) to be connected.
- Use the automatic screen adjustment when a computer screen is displayed for the first time using D-SUB or when the setting of the computer is changed.
- If the audio output from the playback device is connected directly to speakers or other devices, the video on the monitor may appear delayed from the audio portion. Audio should be played through this monitor by connecting the playback device to the monitor's audio input, and connecting the monitor's audio output to the speakers or other devices.
- The audio input terminals used in each input mode are as follows.

Input mode	Audio input terminal
HDMI1	HDMI1 input terminal
HDMI2	HDMI2 input terminal
HDMI3	HDMI3 input terminal
D-SUB	Audio input terminal
USB	USB port

1. HDMI1 input terminal

2. HDMI2 input terminal

3. HDMI3 input terminal

- Use a commercially available HDMI cable (conforming to the HDMI standard) that supports 4K.
- When HDMI is selected, it is not necessary to connect an audio cable to the audio input terminal.

4. D-sub input terminal

5. Audio input terminal

- Use an audio cable without resistance.

6. Audio output terminals

- The output sound varies depending on the input mode.
- The volume of the output sound can be fixed by setting AUDIO OUTPUT on the AUDIO menu.
- It is not possible to control the sound output from the audio output terminals with the AUDIO menu.

7. USB port

- Connect a USB flash drive to the USB port.
- Do not connect a USB device other than a USB flash drive.
- Turn off the power of the monitor when removing a USB flash drive.

Supported USB flash drives

File System	FAT32	NTFS
Capacity	Up to 32 GB.*	Up to 2 TB.

* Maximum file size 4 GB.

- Do not use a USB flash drive with a security function or a write protection function.
- Use a USB flash drive with a shape that can be inserted in the USB port. Some USB flash drives with special shapes cannot be inserted. Do not forcibly insert a USB flash drive. This may damage the connector and cause failure.

8. RS-232C input terminal

- You can control the monitor from a computer by connecting a commercially available RS-232 straight cable between this terminal and the computer.

9. LAN terminal

- You can control the monitor from a computer on a network by connecting a commercially available LAN cable between this terminal and a network.

10. IR output terminal

- You can operate connected external connection equipment through this monitor.
Point the remote control of the external connection equipment toward the remote control sensor on this monitor.

Connecting the Power Cord

! Caution

- Use only the power cord supplied with the monitor.
1. Turn off the main power switch.
 2. Plug the power cord (supplied) into the AC input terminal.
 3. Plug the power cord (supplied) into the power outlet.

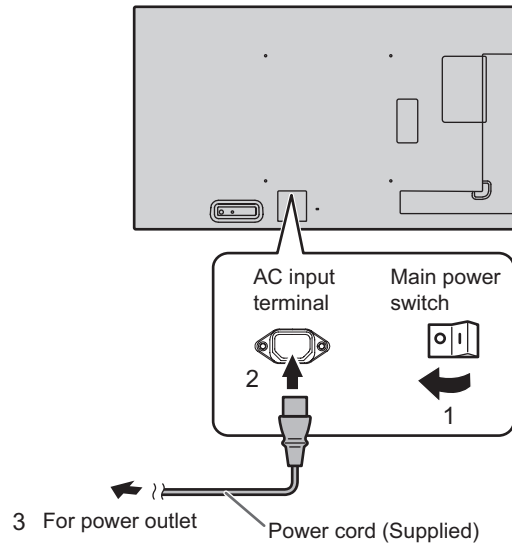

Binding Cables

The supplied cable clamps (affixing type) can be used to clamp the power cord and cables connected to the back of the monitor.

! Caution

- Attach the supplied cable clamps to a flat surface. Do not attach over a vent.
- Remove any dust or dirt before attaching.

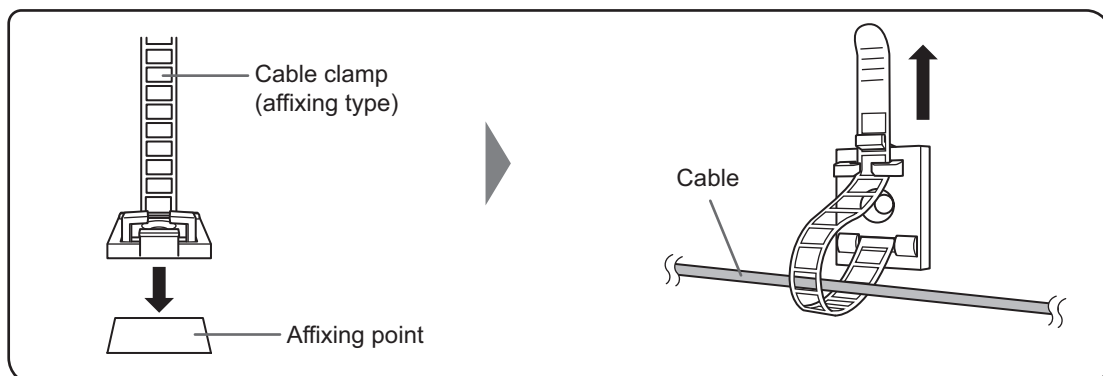

Attaching the USB flash drive cover

1. Insert the USB flash drive into the USB port.

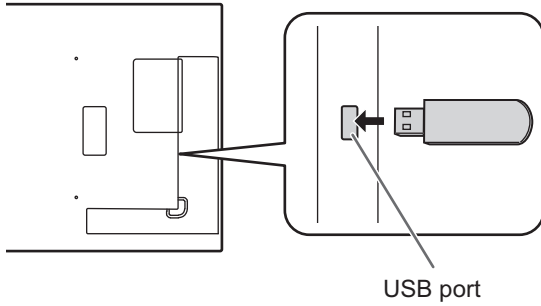

2. Attach the USB flash drive cover and secure with the provided screws (x2).

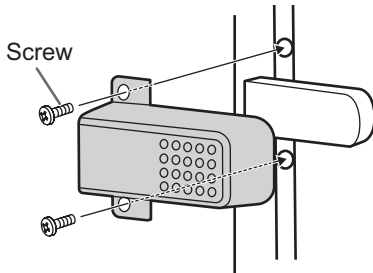

TIPS

- If the USB flash drive cover will be attached, use a USB flash drive with dimensions no greater than 1-15/16 inch (50 mm) (L) (including the terminal) × 13/16 inch (20 mm) (W) × 1/2 inch (12 mm) (H).

Attaching the logo sticker

You can attach the supplied logo sticker on this monitor.
Refer to the following example to attach the sticker as necessary.

Example for landscape orientation

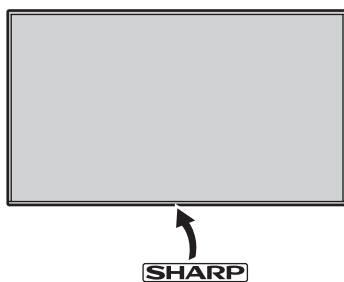

Example for portrait orientation



Preparing the Remote Control Unit

Installing the batteries

1. Place your finger on the part marked with the ▲, and then pull the cover off.

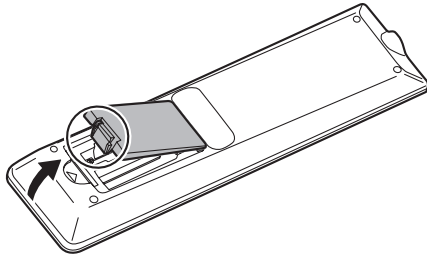

2. See the instructions in the compartment and put in the batteries (R03 or LR03 (“AAA” size) x 2) with their plus (+) and minus (-) sides oriented correctly.
3. Close the cover.

TIPS

- When the batteries become exhausted, replace them with new (commercially available) batteries.
- The supplied batteries may become exhausted quickly depending on how they are stored.
- If you will not be using the remote control for a long time, remove the batteries.
- Use manganese or alkaline batteries only.

Remote control operation range

The operation range of the remote control unit is approx. 16.4 feet (5 m) at an angle of approx 10° from the center to the top/bottom/right/left of the remote control sensor.

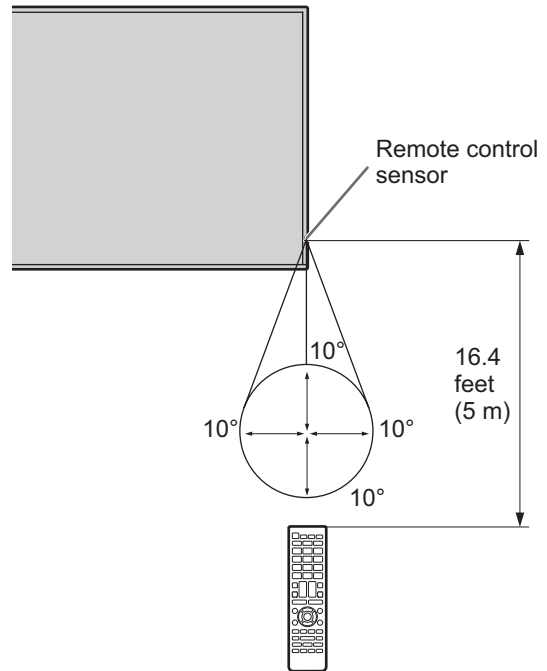

TIPS

- Do not expose the remote control unit to shock by dropping or stepping on it. This could lead to a malfunction.
- Do not expose the remote control unit to liquids, and do not place it in an area with high humidity.
- The remote control unit may not work properly if the remote control sensor is under direct sunlight or strong lighting.
- Objects between the remote control unit and the remote control sensor may prevent proper operation.
- Replace the batteries when they run low as this may shorten the remote control's operation range.
- If a fluorescent light is illuminated near the remote control unit, it may interfere with proper operation.
- Do not use it with the remote control of other equipment such as air conditioner, stereo components, etc.

Turning Power On/Off

! Caution

- Turn on the monitor first before turning on the computer or playback device.
- When switching the main power switch or the POWER button off and back on, always wait for at least 5 seconds. A short interval may result in a malfunction.

Turning on the main power

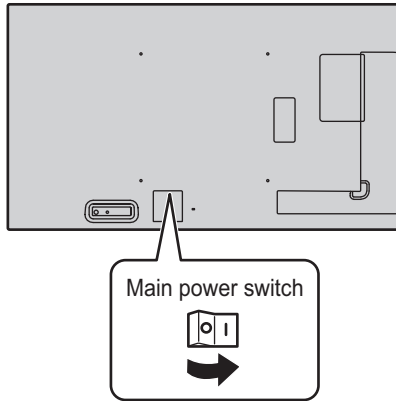

Off mode, when main power is off.

! Caution

- The main power must be turned on/off with the main power switch. Do not connect/disconnect the power cord or turn the breaker on/off while the main power switch is on.
- For a complete electrical disconnection, pull out the main plug.

Turning power on/off

Press the POWER button to turn the power ON/OFF. You can also turn the power ON/OFF by pressing the MONITOR ON button/MONITOR OFF button on the remote control unit.

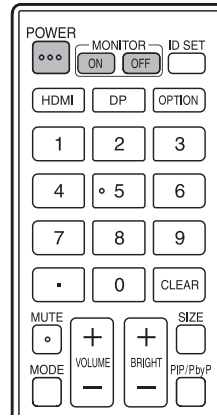

[Rear view]

[Front view]

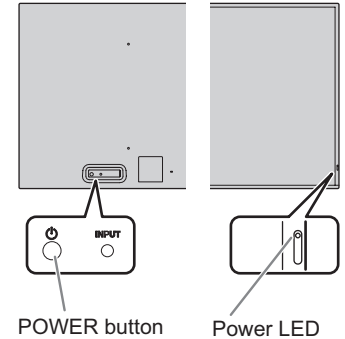

Status	Status of the monitor
Green lit	Power on
Orange lit	Power off (Standby state*)
Green flashing	Input signal waiting state

* Standby mode when POWER SAVE MODE is set to ON. Networked standby mode when POWER SAVE MODE is set to OFF. Networked standby mode allows the monitor to be turned on via network (LAN, RS-232C, and HDMI CEC).

TIPS

- When the main power switch is off, the monitor cannot be turned on.
- If the monitor is in the input signal waiting state and you press the POWER button or MONITOR OFF button, the monitor enters standby state.
- Setting the SCHEDULE flashes the power LED alternately in red and orange in standby state.

Turning Power On/Off

■Power save mode

When the monitor is turned on for the first time after being shipped from the factory, the power save mode setting screen will be displayed. Set it to YES or NO.

YESPOWER SAVE MODE is set to ON.

Standby state is standby mode.

Current consumption is reduced while the monitor is in standby state. Note, however, that the startup time from standby state becomes longer.

NOPOWER SAVE MODE is set to OFF.

Standby state is networked standby mode. Startup time from standby state is reduced. Note, however, that more power will be consumed in standby state.

■Date/time setting

- If the time has yet to be set when the monitor is first turned on, the date/time setting screen appears. Set the date and time.
- Be sure to set the date and time.

TIPS

- The clock stops if the main power remains off for about 1 week.*
(*Approximate time. The actual time varies depending on the state of the monitor.)

Basic Operation

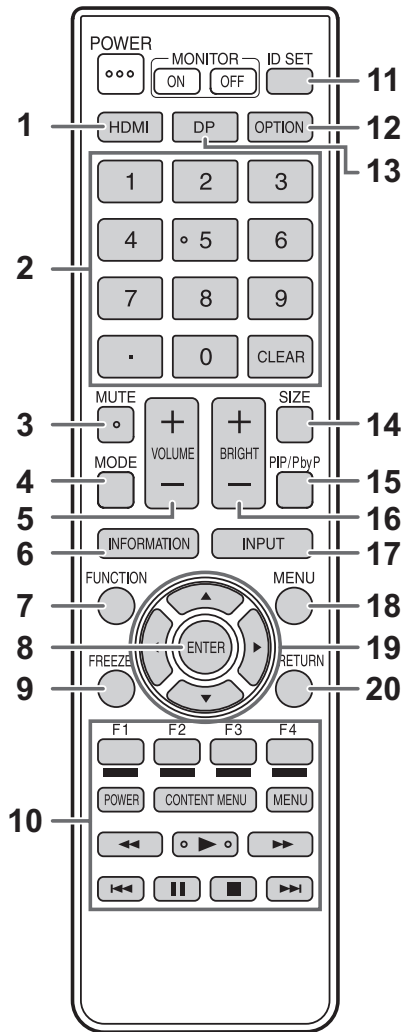

1. HDMI

Switch the input mode to HDMI1, HDMI2 or HDMI3.

2. Numeric input buttons

These buttons are used for setting such as LAN setting.

3. MUTE

Turns off the volume temporarily.

Press the MUTE button again to turn the sound back to the previous level.

4. MODE (Color mode selection)

Each time you press this button, the color mode changes in the following order:

STD (Standard) → VIVID → sRGB → HIGH ILLUMINANCE → STD...

- HIGH ILLUMINANCE is a display with colors suited to bright locations.
- sRGB is international standard of color representation specified by IEC (International Electrotechnical Commission). Color conversion is made in taking account of liquid crystal's characteristics and represents color tone close to its original image.

5. VOLUME +/- (Volume adjustment)

Press + or - to adjust the volume.

6. INFORMATION

Displays monitor information.

7. FUNCTION

Disable the MONITOR BUTTONS LOCK and REMOTE CONTROL LOCK. (See page 26.)

8. ENTER

Confirms the setting.

9. FREEZE

This is not used with this monitor.

10. Buttons for MEDIA PLAYER or operating the HDMI-connected device

- This is used in MEDIA PLAYER. For details, see page 20.
- When HDMI CEC LINK is set to AUTO, use these buttons to operate the device connected through the HDMI interface.

11. ID SET

This is not used with this monitor.

12. OPTION

This is not used with this monitor.

13. DP (DisplayPort)

This is not used with this monitor.

14. SIZE (Screen size selection)

Each time you press this button, the screen size changes. (See page 19.)

15. PIP/PbyP

This is not used with this monitor.

Basic Operation

16. BRIGHT +/- (Brightness adjustment)

Press + or - to adjust the brightness.

17. INPUT (Input mode selection)

The menu is displayed. Press the ▲ or ▼ button to select the input mode, and press the ENTER button to enter.

* You can change the input mode by pressing the INPUT button of the monitor.

Input mode	Video	Audio
HDMI1	HDMI1 input terminal	HDMI1 input terminal
HDMI2	HDMI2 input terminal	HDMI2 input terminal
HDMI3	HDMI3 input terminal	HDMI3 input terminal
D-SUB	D-sub input terminal	Audio input terminal
USB	USB port	USB port

18. MENU

Displays and turns off the menu screen. (See page 22.)

19. Cursor

These buttons are used to perform operations such as selecting items, changing adjustment values, and moving the cursor.

20. RETURN

Returns to the previous screen.

■ Switching the screen size

Even when the screen size is changed, the display may remain the same depending on the input signal.

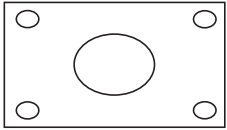
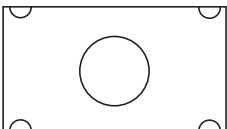
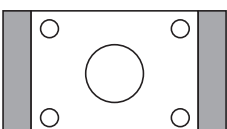
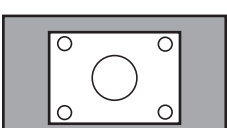
WIDE		Displays image so it fills the entire screen.
ZOOM		The image is enlarged to fill the entire screen without changing the aspect ratio. The edges of the image may be cut off.
NORMAL		Displays the image so it fills the screen without changing the aspect ratio.
Dot by Dot		Displays the dots of the input signals as the corresponding dots on the screen.

TIPS

- Using this monitor's screen-size switching function to compress or expand the screen for commercial or public viewing in establishments like cafes or hotels may infringe on the rights of the creators, as protected by Copyright Law, so please be careful.
- The appearance of the original video may change if you select a screen size with a different aspect ratio than the original image (e.g. TV broadcast or video input from external equipment).
- When 4:3 video is viewed with the whole screen using the screen-size switching function of this monitor, the edge of the video may be lost or appear distorted. If you wish to respect the creator's intentions, set the screen size to "NORMAL".
- When playing commercial software, parts of the image (like subtitles) may be cropped. In this case select the optimal screen size using the screen-size switching function of this monitor. With some software, there may be noise or distortion at the edges of the screen. This is due to the characteristics of the software, and is not a malfunction.
- Depending on the original video size, black bands may remain at the edges of the screen.

Using Media Player

You can play photo, music, and video files in a USB flash drive connected to the monitor.

You can also play Music file during Photo file display.

For information on USB flash drive, see page 10.

■ Supported formats

The types of files that can be played are as follows.

The operation of formats not indicated in the table is not guaranteed.

Photo files

Extension	Max. resolution
.jpg (.jpeg)	15360 x 8640

- Progressive JPEG files are not supported.

Music files

Extension	Audio codec
*.mp3	MPEG-1 L2/L3, MPEG-2 L3

Video files

Video files up to 4K can be played.

Extension	Video codec	Audio codec
*.ts	MPEG2/H.264/H.265	AAC, MP3, LPCM
*.mp4	H.264 MP@5.0/ H.265 Main@5.1	AAC, MP3

- Both video codec and audio codec need to be supported.
- Video files up to 2160p 60 Hz can be played.
- In some cases it may not be possible to play the above files.
- A maximum of 32 alphanumeric characters can be used for folder name and file name.

Playing files

TIPS

- Files are displayed/played according to the order you copy them to a USB flash drive. Copy files to a USB flash drive according to the order you want to play. However, if file system is NTFS, files will be displayed/played according to the order of file name.
- You can have photo or video files play automatically when a USB flash drive is connected or the power is turned on. (See page 21.)

■ Select the type of file to be played

1. Insert the USB flash drive into the monitor. (See page 10.)
2. Change an input mode to [USB]. (See page 18.)
3. Select the type of file to be played with the ◀ or ▶ button, and press the ENTER button.

■ Playing files

1. Displays the file to be played.
Select the folder with the ◀, ▶, ▲ or ▼ button and press the ENTER button to show the files in the folder.
2. Select the file you want to play, and press the ENTER button.
The file is selected.
Multiple files can be selected. You can also select files in different folders.
3. Press the ▶ (Play) button.
The selected files are played.

TIPS

- The played screen size is NORMAL.
- If you press the ▶ (Play) button without selecting a file, all the files in the folder will be played.
- Select "Return" folder to return to the root folder, select "Up Folder" folder to return to the next higher folder.
- The volume can be adjusted with the VOLUME button and MUTE button on the remote control.
- For operations during play, see page 21.

■ To stop play

1. Press the ■ (Stop) button.

Operations during play

When playback starts, you can display the operation bar in the bottom of the screen by pressing the CONTENT MENU button. You can perform the actions below while the operation bar is displayed.

Play / Pause	Play the current file./ Pause the playing file.
FB	Fast backward playing the file. (Music and Movie only)
FF	Fast forward playing the file. (Music and Movie only)
Prev.	Go to the previous file.
Next	Go to the next file.
Stop	Stop the playing file.
RepeatNone / Repeat1file / RepeatALL	RepeatNone: Play files in the playlist only once. Repeat1file: Play and repeat the current file. RepeatALL: Play and Repeat files in the playlist.
Set A / Set B / None	Play and repeat set interval. SetA: Set the interval of the start point. SetB: Set the interval of the end point. (Music and Movie only)
Random On / Random Off	Random On: Play and repeat files of the playlist in random. Random Off: Play files of the playlist in order.
Music On / Music Off	Setting to "Music On", the photo and music files in the same folder are played at the same time. (Photo only)
Playlist	Show Playlist.
Info	Show Playing file information.
Rotate (Clockwise)	Rotate the current file 90 degrees clockwise temporarily. (Photo only)
Rotate (Anti-Clockwise)	Rotate the current file 90 degrees Anti- clockwise temporarily. (Photo only)
Zoom In	The file zooms in. (Photo only)
Zoom Out	The file zooms out. (Photo only)
Move View	Select view area in zoomed. (Photo only)
Slideshow Time	Select Slideshow time. This setting is also applied to auto play and schedule play. The times below are general guidelines, and will vary by file. Short.....About 5 seconds Medium.....About 10 seconds Long.....About 15 seconds (Photo only)

Auto playback

The photo files (in .jpg (.jpeg)) or video files (in .mp4 format) in a USB flash drive can be played automatically.

■ Preparations

Prepare the files. Name the file to be played "001-030" such as "001.jpg" - "030.jpg".

1. Create a folder named "autoplay" in the root folder of a USB flash drive and copy the files to be automatically played to the folder.

Select the type of file.

1. Press the MENU button, and select SETUP with the ◀ or ▶ button, select AUTO PLAY with the ▲ or ▼ button.
2. Select the type of file with the ◀ or ▶ button.

■ Auto playback of files

Connect a USB flash drive (see page 10) and turn on the monitor power.

Auto play starts.

You can connect a USB flash drive (see page 10) after turning on the monitor power.

Auto play starts.

TIPS

- Photos and video cannot be played automatically at the same time.
- Auto play repeatedly plays all photo or video files in the "autoplay" folder.

■ To stop auto play

1. Press the ■ (Stop) button.

Playing files using the SCHEDULE function

The photo files (in .jpg (.jpeg)) or video files (in .mp4 format) in a USB flash drive can be automatically played using the SCHEDULE function.

Set INPUT in SCHEDULE to USB, AUTO PLAY1 or AUTO PLAY2. (See page 26.)

The photo or video files in the folders below will be played.

USB:\autoplay
AUTO PLAY1:\autoplay1
AUTO PLAY2:\autoplay2

TIPS

- Photos and video cannot be played automatically at the same time. Set the type of file to be automatically played by AUTO PLAY in the SETUP menu. (See page 25.)

Menu Items

Displaying the menu screen

Video and audio adjustment and settings of various functions are enabled. This section describes how to use the menu items. See page 23 for details of each menu items.

! Caution

- Do not turn the main power switch off while the menu items are being displayed. Doing so may initialize the settings.

■ Example of operation

(Adjusting CONTRAST in the PICTURE menu)

- Press the **MENU** button to display the menu screen.



- Press the ◀ or ▶ button to select **PICTURE**.
- Press the ▲ or ▼ button to select **CONTRAST**.

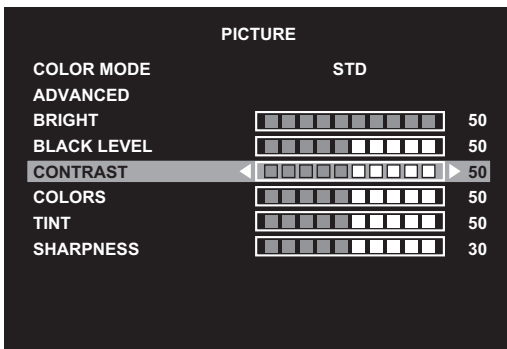

- Press the ◀ or ▶ button to adjust the setting, and press the **RETURN** button.

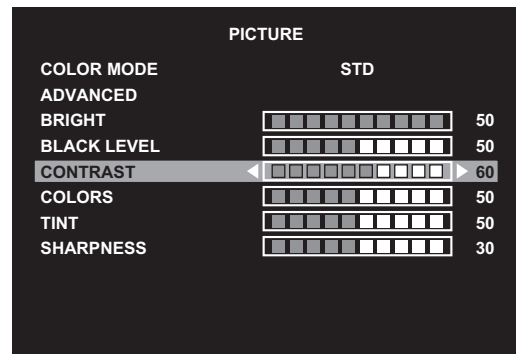

- Press the **MENU** button to close the menu screen.

TIPS

- The menu will differ depending on the input mode.

■ Menu screen display

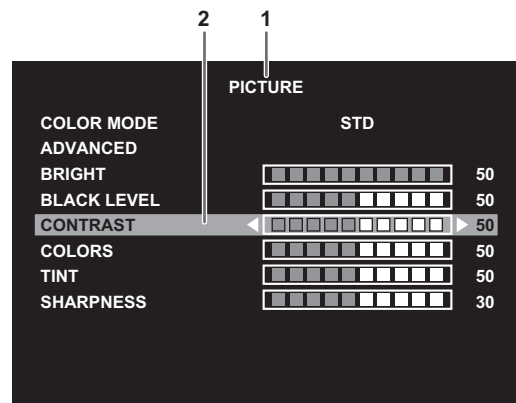

- Name of the menu
- An item being selected (highlighted)

TIPS

- Items that cannot be selected appear in gray. (e.g. Function not supported by the current input signal)

Menu item details

The menu will differ depending on the input mode.

■ PICTURE

COLOR MODE

Changes the color mode on the screen. The color mode on the screen can also be changed using a remote control unit. (See page 17 for details.)

ADVANCED

SIZE

This is the same setting as when SIZE button is pressed. See page 19 for an explanation of the setting.

WHITE BALANCE

THRU Displays the input signal level as is.

PRESET Selects the color temperature using PRESET.

USER Adjusts R-/G-/B-CONTRAST respectively using USER.

PRESET

Selects the color temperature when the WHITE BALANCE is set to PRESET.

The setting values are shown for reference. The color temperature of the screen varies over time. This function is not intended to keep the color temperature constant.

USER

Adjusts each item when the WHITE BALANCE is set to USER.

R-CONTRAST.... Adjusts bright-toned red component.

G-CONTRAST ... Adjusts bright-toned green component.

B-CONTRAST.... Adjusts bright-toned blue component.

NR

Reduce the image noise.

Setting a higher level reduces more noise. However, it may cause blurring on an image.

ACTIVE CONTRAST*

Set whether to ON or OFF active contrast.

* Only for YCbCr 4:2:2 or YCbCr 4:2:0.

GAMMA

Selects the gamma.

HDMI RGB INPUT RANGE

Sets the RGB input signal range.

When using HDMI set to AUTO, the RGB input signal range is detected automatically. Use AUTO normally.

If the RGB input signal range cannot be set appropriately even when using AUTO, set according to the image. When the setting is different, images will be displayed with washed out blacks and compressed gradients.

BRIGHT

Adjusts the backlight brightness.

BLACK LEVEL

Adjusts the entire brightness of the video signals.

CONTRAST (HDMI)

Adjusts the difference between the bright and dark portions of the image.

COLORS (HDMI)

Adjusts the color intensity.

TINT (HDMI)

Adjusts the hue. Selecting + changes the color towards green, and selecting - changes it towards magenta.

SHARPNESS (HDMI)

Adjusts the sharpness of the image.

Menu Items

■AUDIO

TREBLE

Adjusts the volume of treble-level sound.

BASS

Adjusts the volume of bass-level sound.

BALANCE

Adjusts the balance of the audio sound between right and left.

SPEAKER

Selects the speaker to be used.

AUDIO OUTPUT

Sets the volume of sound output from the audio output terminals.

VARIABLE You can adjust the volume using VOLUME.

FIXED Fixes the sounds.

■SETUP

LANGUAGE

Sets the display language for the menu screen.

DATE/TIME SETTING

Set the date and time.

TIME FORMAT Sets the time display format.

Select 12- or 24-hour time.

SCHEDULE (See page 26.)

You can turn the power on/off at a specified time.

Files in a USB flash drive can also be played at a specified time.

HDMI CEC LINK

AUTO Use the HDMI CEC function.

If the device connected to the HDMI input terminal supports CEC, the input mode of the monitor changes to HDMI when playback starts on the device.

OFF HDMI CEC function is not used.

HDMI MODES

HDMI MODES settings change how the content displayed is processed and decoded using the HDMI input terminal.

MODE1 Normally used.

This will support most common color spaces and other encoding signals.

MODE2 Use this when input signal does not display correctly in MODE1. Up to 4K30p can be displayed.

COMMUNICATION SETTING

RS-232C/LAN SELECT

Selects the method with which to control the monitor from the computer.

LAN SETUP

Configures the settings to control the monitor from the computer via LAN. (See page 31.)

SCREEN**AUTO (D-SUB)**

The CLOCK, PHASE, H-POS, and V-POS are automatically adjusted.

Pressing the ENTER button performs adjustment. Use this automatic adjustment when you use the D-SUB to display a computer screen for the first time or when you change the setting of the computer. (See page 27.)

CLOCK (D-SUB)

Adjusts frequency for sampling clock for applicable video.

Adjust when there is flickering in the form of vertical stripes.

When using the adjustment pattern (see page 27), make adjustments so that no vertical stripe noise appears in it.

PHASE (D-SUB)

Adjusts sampling clock phase for applicable video. Useful when small characters appear with low contrast and/or there are flickers at corners. When using the adjustment pattern (see page 27), make adjustments so that no horizontal stripe noise appears in it.

* Adjustments to PHASE should be made only after CLOCK has been correctly set.

H-POS (D-SUB)

Adjust the horizontal position of the image.

V-POS (D-SUB)

Adjust the vertical position of the image.

RESET

Resets the values of the SCREEN menu items to the factory default settings.

Select YES and then press the ENTER button.

POWER SAVE MODE

When OFF is selected, standby state is networked standby mode. Startup time from standby state is reduced. Note, however, that more power will be consumed in standby state.

When ON is selected, standby state is standby mode. Current consumption is reduced while the monitor is in standby state.

Note, however, that the startup time from standby state becomes longer.

Certain RS-232C commands and LAN control cannot be used in standby mode. (See pages 28 and 31.)

OFF IF NO OPERATION

Set whether or not the monitor goes into standby state when there is no operation from the remote control or RS-232C / LAN. After setting this to ON, the monitor goes into standby state when there is no operation for more than 4 hours.

POWER MANAGEMENT

POWER MANAGEMENT determines whether or not to switch modes from no signal to the input signal waiting state.

NO SIGNAL AUTO INPUT SEL.

Specify whether to change inputs automatically. When ON is selected and no signal is present in the selected input mode, the monitor automatically changes the selected mode to another mode where a video signal is present.

When video signals exist in multiple input modes, the switching is as follows:

USB (when a USB flash drive is connected), HDMI1, HDMI2, HDMI3, D-SUB

(Input mode switching may take 15 seconds or more, depending on the connected equipment. When there are no signals at any of the input terminals, switching is continued until an input signal is detected and the monitor does not enter input signal waiting state.)

AUTO PLAY

Set the type of file to be automatically played from a USB flash drive. (See page 21.)

Menu Items

MONITOR BUTTONS LOCK

You can disable the monitor buttons.

To disable MONITOR BUTTONS LOCK, press the FUNCTION button and then press the ▲, ▼, ◀ and ▶ buttons in this sequence.

REMOTE CONTROL LOCK

You can disable the remote control unit buttons.

UNLOCKED..... Enable the remote control unit buttons.

LOCK ALL..... Disable remote control unit buttons.

LOCK EXCEPT VOLUME Disable remote control unit buttons except volume adjustment buttons.

LOCK EXCEPT POWER..... Disable remote control unit buttons except POWER button.

To disable REMOTE CONTROL LOCK, press the FUNCTION button and then press the ▲, ▼, ◀ and ▶ buttons in this sequence before REMOTE CONTROL LOCK disappears.

THERMAL SENSOR SETTING

Select the installation direction of the monitor.

LANDSCAPE.....Landscape orientation

PORTRAITPortrait orientation

FACE UPScreen faces up

FACE DOWN.....Screen faces down

LED

Specifies whether to light the power LED.

INFORMATION

Displays monitor information.

ROTATE 180°

If video is upside down when the monitor is installed in portrait orientation, you can rotate the video 180 degrees.

Interlaced signals may not be displayed properly.

ALL RESET

Resets the settings to the factory default settings.

TIPS

- When WHITE BALANCE is set to THRU, BLACK LEVEL, CONTRAST, TINT, COLORS, GAMMA, PRESET, USER and ACTIVE CONTRAST cannot be set.
- If COLOR MODE is set to sRGB, the following items cannot be set.
WHITE BALANCE, PRESET, USER, ACTIVE CONTRAST, and GAMMA
- When the COLOR MODE is set to VIVID or HIGH ILLUMINANCE, GAMMA cannot be adjusted.

■ SCHEDULE

You can set the time to switch the monitor on and off.

An auto play file in a USB flash drive (see page 21) can also be played at a specified time.

Set this function with SCHEDULE in the SETUP menu. (See page 24.)

1. **Insert the USB flash drive to be played into USB port on the monitor when playing files. (See page 10.)**
2. **Press the ▲ or ▼ button to select the SCHEDULE number, and press the ENTER button.**
3. **Set the SCHEDULE.** (See below)
Move through the items with the ▲ or ▼ button, and set each item.
4. **Press the MENU button.**
SCHEDULE becomes effective.

(1) ON/OFF

Enable/disable the SCHEDULE.

(2) ON TIME

Specify the time the power turns on.

Set the time with the ◀, ▶, ▲ or ▼ button and press the RETURN button.

(3) OFF TIME

Specify the time the power turns off.

Set the time with the ◀, ▶, ▲ or ▼ button and press the RETURN button.

(4) REPEAT MODES

Select the day of the week the schedule will be executed. Press the ENTER button to change the setting, and press the RETURN button.

- **ONLY ONCE**
The SCHEDULE will be executed once only regardless of the day of the week. When the schedule is set to ONLY ONCE, the setting is cleared after the schedule is executed.
- **EVERY SUN - EVERY SAT**
Executes the SCHEDULE on the specified day every week.
Multiple days of the week can be specified.

(5) INPUT

Specify the input mode at power on.

! Caution

- Do not turn off the main power after setting the SCHEDULE.
- Schedule ON and then OFF only take place in standby state and input signal waiting state.
- Specify the correct date and time. (See page 24.) SCHEDULE does not function unless the date and time are specified.
- Check regularly that the set date and time are correct.

TIPS

- Up to 7 SCHEDULE items can be registered.
- Setting the SCHEDULE flashes the power LED alternately in red and orange in standby state.
- A SCHEDULE that has a small number has precedence over that of a large number when schedules overlap.

Adjustments for computer screen display**■ Automatic adjustment**

When you use the D-SUB to display a computer screen for the first time, or when you change the setting of the computer, use the automatic screen adjustment.

1. **Switch the input to D-SUB and display the adjustment pattern.** (See the description below.)
2. **Press the MENU button and use the ◀ or ▶ button to display the SETUP menu.**
3. **Press the ▲ or ▼ button to select SCREEN, and press the ▶ button.**
4. **Press the ▲ or ▼ button to select AUTO, and press the ▶ button.**
The automatic adjustment is complete in several seconds.
5. **Press the MENU button to close the menu screen.**

TIPS

- If the screen cannot be adjusted properly with one automatic adjustment, repeat the automatic adjustment two or three times. Try manual adjustment if necessary.

■ Screen display for adjustment

Before making adjustments in the SCREEN menu or PICTURE menu, display an image to brighten the entire screen.

If you are using a Windows computer, use the adjustment pattern. The adjustment pattern can be downloaded from home page.

<https://business.sharpusa.com/product-downloads>

- * You must be in a network environment that allows access to the Internet.

Opening the adjustment pattern

1. **Double-click [Adj_uty.exe] downloaded.**

The adjustment pattern will appear.

Adjust the screen automatically or manually.

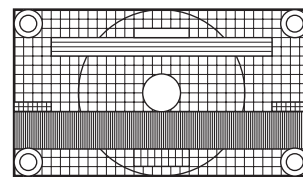

2. **When adjustment is finished, press the [Esc] on the computer's keyboard to quit the adjustment program.**

TIPS

- If the display mode on the computer you are using is 65000 colors, the color levels in the color pattern may appear differently or grayscale may appear to be colored. (This is due to the specifications of the input signal and is not a malfunction.)

Controlling the Monitor with a computer (RS-232C)

You can control this monitor from a computer via RS-232C (COM port) on the computer.

TIPS

- To control the monitor via RS-232C, set RS-232C/LAN SELECT to RS-232C. (See page 24.)
- You cannot use RS-232C and LAN control simultaneously.

Computer connection

Connect with RS-232 straight cable between the computer's COM port (RS-232C connector) and the RS-232C input terminal on the monitor.

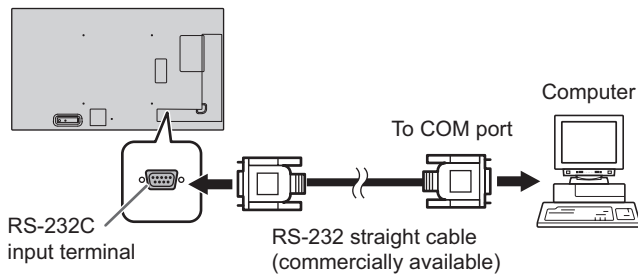

Communication conditions

Set the RS-232C communication settings on the computer to match the monitor's communication settings as follows:

Baud rate	9600bps
Data length	8 bits
Parity bit	None

Stop bit	1 bit
Flow control	None

Communication procedure

■Command format

When a command is sent from the computer to the monitor, the monitor operates according to the received command and sends a response message to the computer.

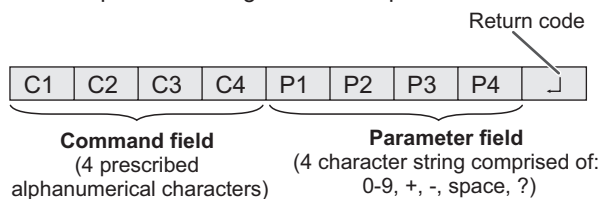

Example: VOLM0030
VOLM 30

- * Be sure to input 4 characters for the parameter. Pad with spaces (" ") if necessary. (" " is a return code (0DH, 0AH or 0DH))
Wrong : VOLM30
Right : VOLM 30

The current value can be returned by using "?" as the parameter.

Example:

VOLM ? ? ? ?	←	From computer to monitor (How much is current volume setting?).
30	←	From monitor to computer (Current volume setting: 30).

■Response code format

When a command has been executed correctly

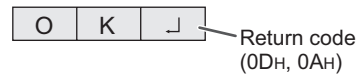

A response is returned after a command is executed.

When a command has not been executed



TIPS

- "ERR" is returned when there is no relevant command or when the command cannot be used in the current state of the monitor.
- If communication has not been established for reasons such as a bad connection between the computer and monitor, nothing is returned (not even ERR).
- "ERR" may be returned when a command cannot be received correctly due to interference from the surrounding environment. Please ensure that the system or software resends the command if this occurs.

■Communication interval

- After OK or ERR is returned, you must send the following commands.
To set a timeout for the command response, specify 10 seconds or longer.
- Provide an interval of 100 ms or more between the command response and the transmission of the next command.

RS-232C command table

How to read the command table

- Command: Command field (See page 28.)
- Direction: W When the "Parameter" is set in the parameter field (see page 28), the command functions as described under "Control/Response Contents".
 R The returned value indicated under "Reply" can be obtained by setting "?????" or "____?" in the parameter field. (See page 28.)
- Parameter: Parameter field (See page 28.)
- Reply: Response (Returned value)
- * : "●" : Indicates a command which can be used in standby state, input signal waiting state or when the power is on.
 "△" : Indicates a command which can be used in input signal waiting state or when the power is on.
 "—" : Indicates a command which can be used when the power is on.

Power control/Input mode selection

Function	Command	Direction	Parameter	Reply	Control/Response contents	*
POWER CONTROL	POWR	W	0		Switches to standby state.	●
			1		Returns from standby state.	
		R	0		Standby state	
			1		Normal mode	
			2		Input signal waiting state	
INPUT MODE SELECTION	INPS	WR	0		Toggle change for input mode.	△
			2		D-SUB	
			10		HDMI1	
			11		USB	
			13		HDMI2	
			18		HDMI3	

PICTURE menu

Function	Command	Direction	Parameter	Reply	Control/Response contents	*
BRIGHT	VLMP	WR	0-50	0-50		
SIZE (Screen size selection)	WIDE	WR	1-4	1-4	1: WIDE, 2: NORMAL, 3: Dot by Dot, 4: ZOOM	
COLOR MODE	BMOD	WR	0	0	STD	-
			2	2	VIVID	
			3	3	sRGB	
			4	4	HIGH ILLUMINANCE	
WHITE BALANCE	WHBL	WR	0-2	0-2	0:THRU, 1:PRESET, 2:USER	
R-CONTRAST	CRTR	WR	0-255	0-255	"ERR" when WHBL is not set to 2.	
G-CONTRAST	CRTG	WR	0-255	0-255		
B-CONTRAST	CRTB	WR	0-255	0-255		

SETUP menu

Function	Command	Direction	Parameter	Reply	Control/Response contents	*
DATE/TIME SETTING	DATE	WR	AABBCCDDEE	AABBCCDDEE	AA: Year, BB: Month, CC: Day, DD: Hour, EE: Minute	
Telnet User name	USER	WR	XXXXXXXX	XXXXXXXX	8 characters or less; half-width alphanumeric characters, "-", and "_". (The field can be left blank, but spaces cannot be entered.)	
Telnet Password	PASS	WR	XXXXXXXX	XXXXXXXX	8 characters or less; half-width alphanumeric characters, "-", and "_". (The field can be left blank, but spaces cannot be entered.)	
THERMAL SENSOR SETTING	STDR	WR	0-3	0-3	0: LANDSCAPE, 1: PORTRAIT, 2: FACE UP, 3: FACE DOWN	
Model	INF1	R		Value		●
Serial no.	SRNO	R		Value		
AUTO	ASNC	W	1		Adjust CLOCK/PHASE/H-POS/V-POS automatically in D-SUB	
ALL RESET	RSET	W	0			

Controlling the Monitor with a computer (RS-232C)

Others

Function	Command	Direction	Parameter	Reply	Control/Response contents	*
VOLUME	VOLM	WR	0-31	0-31		
MUTE AUDIO	MUTE	WR	0-1	0-1	0: OFF, 1: ON	-
Temperature sensor	DSTA	R		0	Internal temperature normal	●
				1	Internal temperature abnormal has occurred and the monitor is in standby state	
				2	Internal temperature abnormal occurred (To delete the information of temperature abnormal, turn off the main power.)	
				3	Internal temperature abnormal has occurred and backlight brightness is dimmed	
				4	Temperature sensor abnormal	
Temperature acquisition	ERRT	R		Value	Returns the temperature at the temperature sensors. Indicates a temperature sensor abnormality when "126" is returned.	-
Check the resolution	PXCK	R		-	Returns current resolution in the form of hhh, vvv.	

Controlling the Monitor with a computer (LAN)

Your monitor can be connected to a LAN allowing you to control it from a computer on the LAN. The connection requires a commercially available LAN cable (UTP cable, Category 5, straight through).

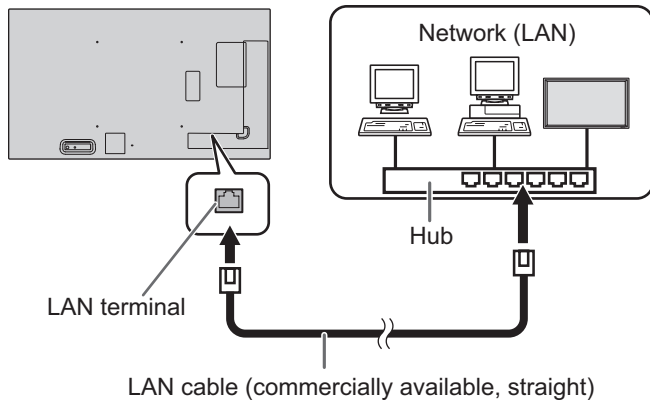

! Caution

- When you use a network, your communication data is exposed to the risks of being stolen or illegally accessed. To avoid these risks, you need to use this monitor in a secure network environment.

TIPS

- When POWER SAVE MODE is set to ON, the control is disabled in the standby mode/input signal waiting state.
- To control the monitor via LAN, set RS-232C/LAN SELECT to LAN. (See page 24.)
- You cannot use RS-232C and LAN control simultaneously.

■ To set on the monitor

Set RS-232C/LAN SELECT of COMMUNICATION SETTING on the SETUP menu to LAN, and then set the LAN SETUP options. (See page 24.)

After setting each item, select SET and press the ENTER button.

VIEW NETWORK SETTINGS

Displays LAN setting information.

DHCP CLIENT

If your LAN has a DHCP server and you wish to obtain an address automatically, change this setting to ON. To set the address manually, set this to OFF.

IP ADDRESS

If the DHCP CLIENT is set to OFF, specify an IP address. Press the ◀ or ▶ button to select the items, and enter the values with the numeric input buttons (0 to 9). You can also change the values with the ▲ or ▼ button.

SUBNET MASK

If the DHCP CLIENT is set to OFF, specify the subnet mask. Press the ◀ or ▶ button to select the items, and enter the values with the numeric input buttons (0 to 9). You can also change the values with the ▲ or ▼ button.

DEFAULT GATEWAY

If the DHCP CLIENT is set to OFF, specify the default gateway.

If you are not using a default gateway, specify "000.000.000.000".

Press the ◀ or ▶ button to select the items, and enter the values with the numeric input buttons (0 to 9).

You can also change the values with the ▲ or ▼ button.

SET

Save the setting.

Command-based control

You can control the monitor using RS-232C commands (see page 29) via terminal software and other appropriate applications.

Read the manual for the terminal software for detailed instructions.

(1) Connect the computer to the monitor.

1. Specify the IP address and data port number (10008) and connect the computer to the monitor.

When connection has been established successfully, [Login:] is returned as response.

2. Send the user name.

- Send [user name] + [□].

- If the user name is not set, send [□].

- When the transmission is successful, [□ Password:] is returned as response.

3. Send the password.

- Send [password] + [□].

- If the password is not set, send [□]. [□ New password:] is returned as response. Please set a password.

- Send [password] + [□]. [□ Retype new password:] is returned as response. Send [password] + [□] again.

- When the transmission is successful, [OK □] is returned as response.

(2) Send commands to control the monitor.

- The commands used are the same as those for RS-232C. Refer to the communication procedure (see page 28) for operation.

- Usable commands are provided in the RS-232C command table (see page 29).

(3) Disconnect the connection with the monitor and quit the function.

1. Send [BYE □].

When the transmission is successful, [goodbye] is returned and the connection is disconnected.

Troubleshooting

If you are experiencing any problem with your display, before calling for service, please review the following troubleshooting tips.

There is no picture or sound.

- The power LED is off.
 - Is power supplied to this monitor?
 - Is the power cord disconnected? (See page 12.)
 - Is the main power switch off? (See page 15.)
- The power LED lights orange.
 - This monitor is in standby state. Turn on the power. (See page 15.)
- The power LED flashes green.
 - There is no input signal.
 - Is an input mode selected that is appropriate for the input terminal to which the cable is connected? (See page 18.)
 - If any external equipment is connected, make sure the equipment is operating (playing back).

Remote control does not work.

- Are the batteries inserted with polarity (+,-) aligned? (See page 14.)
- Are the batteries exhausted?
- Point the remote control unit toward the monitor's remote control sensor. (See page 14.)

Sound from left and right speakers is reversed.

Sound is heard from only one side.

- Are audio cables connected properly?

There is a picture but no sound.

- Is the sound muted?
- Make sure the volume is not set to minimum.
- Are audio cables connected properly?

Unstable video.

- The signal may be incompatible.
- Try the automatic screen adjustment when D-SUB is in use.

The video from the HDMI input terminal does not appear properly.

- Does the HDMI cable support 4K, and is it HDMI standard compliant? The monitor will not work with cables that are not standard compliant.
- Is the input signal compatible with this monitor? (See pages 35 and 36.)
- If the connected device does not support 4K, set HDMI MODES to MODE2.

The video from D-Sub input terminal does not appear correctly.

- Is the input signal compatible with this monitor? (See page 35.)

Control buttons do not work.

There is no picture.

- Load noises from outside may be interfering with normal operation. Turn off the main power and turn it on after waiting at least 5 seconds, and then check the operation.

The input mode changes automatically.

- When NO SIGNAL AUTO INPUT SEL. is ON and the current video signal input stops, the input mode automatically changes to the mode of an active video signal.
Consequently, the input mode may change even in the following cases:
 - When a computer enters standby mode.
 - When video play is stopped with a playback device.

When "AUTO DIMMING" is displayed.

- When the internal temperature of the monitor rises excessively, the brightness of the backlight automatically decreases in order to prevent a further temperature rise. If you attempt to adjust the brightness while the monitor is in this state, "AUTO DIMMING" is displayed and you cannot change the brightness.
- Remove the cause of the excessive temperature rise.

The monitor makes a cracking sound.

- You may occasionally hear a cracking sound from the monitor. This happens when the cabinet slightly expands and contracts according to change in temperature. This does not affect the monitor's performance.

The Power LED is flashing in red and green alternately.

When "TEMPERATURE" is displayed in the corner of the screen.

- When the internal temperature of the monitor rises excessively, the brightness of the backlight decreases automatically in order to prevent high-temperature-related problems. When this occurs, "TEMPERATURE" is displayed on the screen and the Power LED flashes red and green alternately.
- If the internal temperature rises further, the monitor automatically enters standby state. (The Power LED continues flashing red and green alternately.)
- Remove the cause of the excessive temperature rise.
 - If the monitor enters standby state due to a rise in temperature, to return to normal display, turn the power switch off and then back on again. The monitor, however, will enter standby state again if the cause of the temperature rise is not eliminated. (See page 7.)
 - Check whether the monitor is placed at a location where a quick rise in temperature is likely. Internal temperature rises quickly if the vents on the monitor are blocked.
 - Internal temperature rises quickly if dust accumulates inside the monitor or around the vents. Remove dust if possible. Ask SHARP dealer about removing internal dust.

Specifications

■Product Specifications

Model	PN-HS551	PN-HY551	PN-HS501	PN-HY501	PN-HS431	PN-HY431
LCD component	55" Class [54-5/8 inch (138.783 cm) diagonal] TFT LCD		50" Class [49-1/2 inch (125.730 cm) diagonal] TFT LCD		43" Class [42-1/2 inch (107.986 cm) diagonal] TFT LCD	
Max. resolution (pixels)	3840 x 2160					
Max. colors	Approx. 1.07 billion colors					
Pixel pitch	0.315 mm (H) × 0.315 mm (V)		0.2854 mm (H) × 0.2854 mm (V)		0.2451 mm (H) × 0.2451 mm (V)	
Brightness (typical) *1	700 cd/m ²	500 cd/m ²	700 cd/m ²	500 cd/m ²	700 cd/m ²	500 cd/m ²
Contrast ratio (typical)	5000: 1		4000: 1		1200: 1	
Viewing angle	178° right/left/up/down (contrast ratio ≥ 10)					
Screen active area inch (mm)	47-5/8 (W) x 26-13/16 (H) (1209.6 x 680.4)		43-1/8 (W) x 24-1/4 (H) (1095.84 x 616.41)		37-1/16 (W) x 20-13/16 (H) (941.184 x 529.416)	
Computer input signal	Analog RGB (0.7 Vp-p) [75 Ω]					
Sync signal	Horizontal/vertical separate (TTL: positive/negative)					
Plug and play	VESA DDC2B					
Input terminals	Video	Mini D-sub 15 pin, 3 rows x 1 HDMI x 3				
	Serial (RS-232C)	D-sub 9 pin x 1				
	Audio	3.5 mm mini stereo jack x 1				
Output terminals	Audio	RCA pin (L/R) x 1				
	IR	3.5 mm mini stereo jack x 1 *2				
USB port	USB (USB 2.0 compliant) x 1					
LAN terminal	10 BASE-T/100 BASE-TX					
Speaker output	10 W + 10 W					
Power requirement	AC 100 - 240 V, 2.1 A, 50/60 Hz	AC 100 - 240 V, 1.8 A, 50/60 Hz	AC 100 - 240 V, 1.7 A, 50/60 Hz	AC 100 - 240 V, 1.3 A, 50/60 Hz	AC 100 - 240 V, 1.6 A, 50/60 Hz	AC 100 - 240 V, 1.2 A, 50/60 Hz
Operating temperature *3	32°F to 104°F (0°C to 40°C)					
Operating humidity	20% to 80% (no condensation)					
Power consumption (input signal waiting state / networked standby mode *4 / standby mode *4 / off mode)	190W (1.0W / 1.0W / 0.5W / 0.0 W)	150W (1.0W / 1.0W / 0.5W / 0.0 W)	110W (1.0W / 1.0W / 0.5W / 0.0 W)	140W (1.0W / 1.0W / 0.5W / 0.0 W)	100W (1.0W / 1.0W / 0.5W / 0.0 W)	100W (1.0W / 1.0W / 0.5W / 0.0 W)
Dimensions inch (mm) (excluding protrusions)	Approx. 48-7/8 (W) x 2-1/2 (D) x 28-1/16 (H) (1241.8 x 63.5 x 712.6)		Approx. 44-7/16 (W) x 2-1/2 (D) x 25-9/16 (H) (1128.4 x 63.5 x 649)		Approx. 38-5/16 (W) x 2-1/2 (D) x 22-1/8 (H) (973 x 63.5 x 561.2)	
Weight lbs. (kg)	Approx. 39.7 (18.0)		Approx. 33.1 (15.0)		Approx. 25.4 (11.5)	

*1 Brightness will depend on input mode and other picture settings. Brightness level will decrease over time. Due to the nature of the equipment, it is not possible to precisely maintain a constant level of brightness.

*2 The conversion cable to D-sub 9 pins is an option.

*3 When using the monitor laying flat on a surface (when the monitor is tilted more than 20 degrees upward or downward from the perpendicular in relation to a level surface), use the monitor at a temperature between 32°F (0°C) to 86°F (30°C). Temperature condition may change when using the monitor together with the optional equipments recommended by SHARP. In such cases, please check the temperature condition specified by the optional equipments.

*4 No optional part is attached.

As a part of our policy of continuous improvement, SHARP reserves the right to make design and specification changes for product improvement without prior notice. The performance specification figures indicated are nominal values of production units. There may be some deviations from these values in individual units.

Specifications

■ Dimensional Drawings

Note that the values shown are approximate values.

[PN-HS551/PN-HY551]

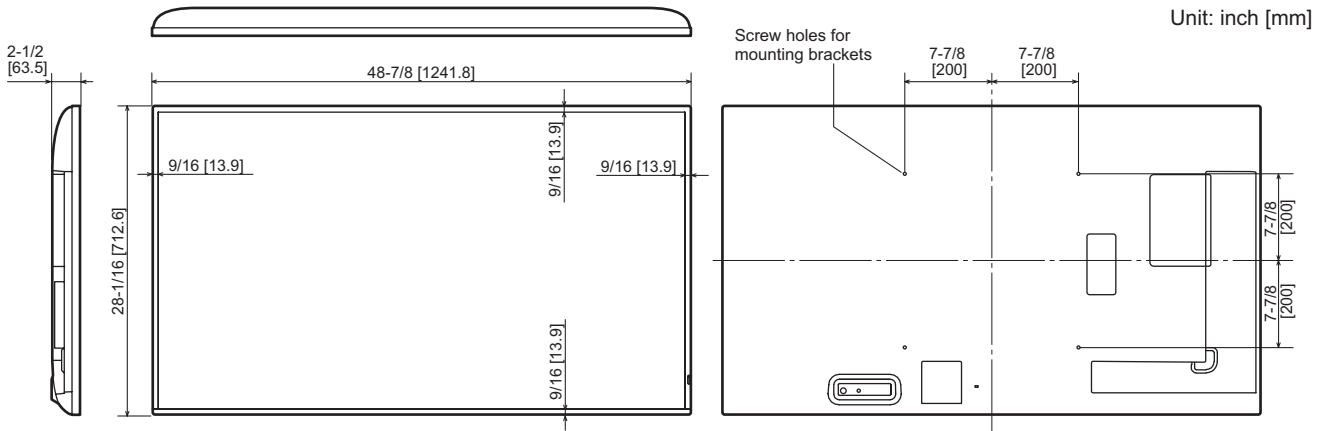

[PN-HS501/PN-HY501]

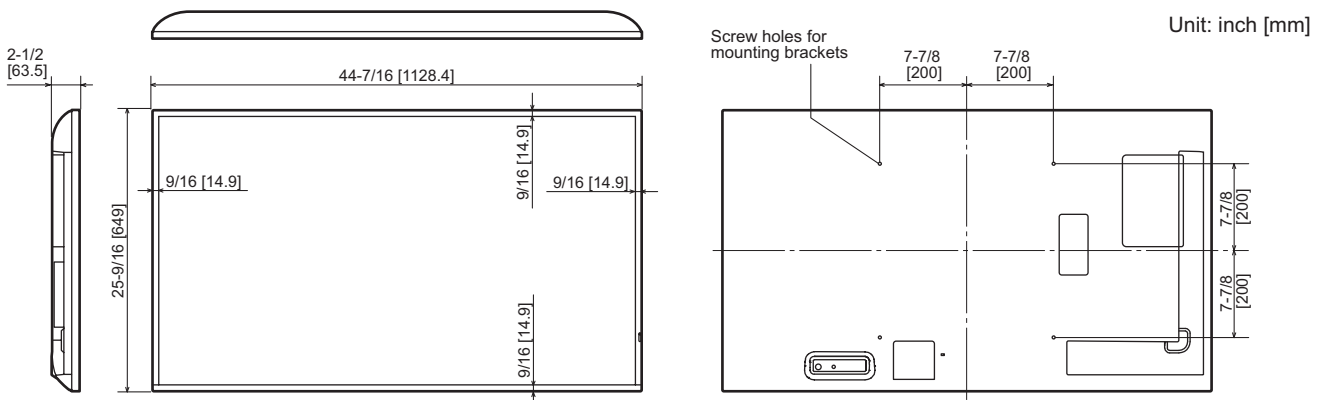

[PN-HS431/PN-HY431]

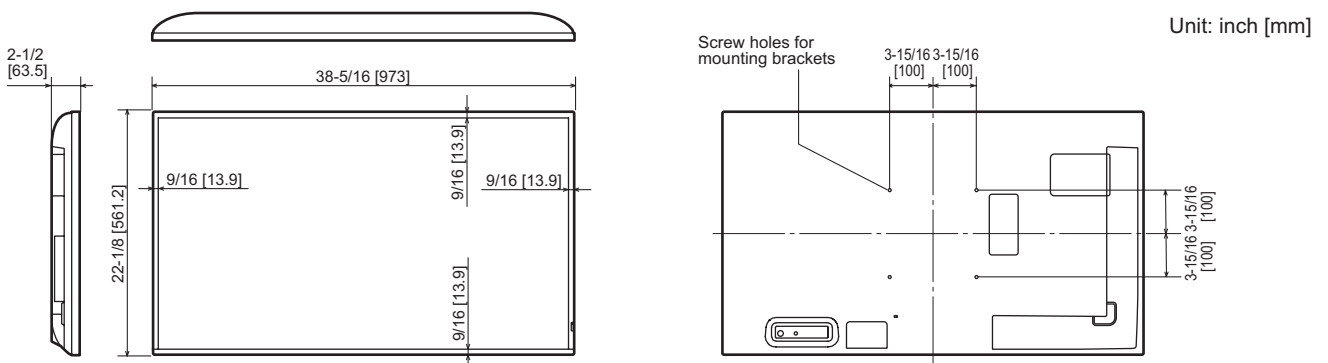

When mounting the monitor, be sure to use a wall-mount bracket that complies with the VESA-compatible mounting method. SHARP recommends using M6 screws and tighten the screws. Note that screw hole depth of the monitor is 1/2 inch (12 mm). Loose mounting may cause the product to fall, resulting in serious personal injuries as well as damage to the product. The screw and hole should come together with over 3/8 inch (10 mm) length of thread. Use a bracket which has been approved for UL1678 standard, and which can endure at least 4 times or more the weight of the monitor.

■DDC (plug and play)

The monitor supports the VESA DDC (Display Data Channel) standard.

DDC is a signal standard for plug and play between monitors and computers. Information about resolution and other parameters is exchanged between the two. This function can be used if the computer supports DDC and it has been configured to detect plug-and-play monitors.

There are several types of DDC, depending on the communication method used. This monitor supports DDC2B.

■Compatible signal timing (PC)

Screen resolution		Hsync	Vsync	Dot frequency	Digital	Analog (D-SUB)	
					HDMI		
VESA	640 × 480	31.5kHz	60Hz	25.175MHz	Yes	Yes	
	800 × 600	37.9kHz	60Hz	40.0MHz	Yes	Yes	
	848 × 480	31.0kHz	60Hz	33.75MHz	-	Yes	
	1024 × 768	48.4kHz	60Hz	65.0MHz	Yes	Yes	
	1280 × 800	49.7kHz	60Hz	83.5MHz	Yes	Yes	
	1280 × 960	60.0kHz	60Hz	108.0MHz	Yes	Yes	
	1280 × 1024	64.0kHz	60Hz	108.0MHz	Yes	Yes	
		80.0kHz	75Hz	135.0MHz	Yes	Yes	
	1360 × 768	47.7kHz	60Hz	85.5MHz	Yes	-	
	1400 × 1050	65.3kHz	60Hz	121.75MHz	Yes	-	
	1440 × 900	55.9kHz	60Hz	106.5MHz	Yes	Yes	
1680 × 1050	65.3kHz	60Hz	146.25MHz	Yes	Yes		
Wide	1280 × 720	44.7kHz	60Hz	74.4MHz	Yes	Yes	
	1920 × 1080	67.5kHz	60Hz	148.5MHz	Yes	Yes	
	3840 × 2160	54.0kHz	24Hz	297.0MHz	Yes	-	
		56.25kHz	25Hz	297.0MHz	Yes	-	
		67.5kHz	30Hz	297.0MHz	Yes	-	
		112.5kHz	50Hz	594.0MHz	Yes	-	
		135kHz	60Hz	594.0MHz	Yes	-	
	4096 × 2160 ^{*1}	54.0kHz	24Hz	297.0MHz	Yes	-	
		56.0kHz	25Hz	297.0MHz	Yes ^{*2}	-	
		67.0kHz	30Hz	297.0MHz	Yes ^{*2}	-	
		112.5kHz	50Hz	594.0MHz	Yes	-	
		135.0kHz	60Hz	594.0MHz	Yes	-	
	US TEXT	720 × 400	31.5kHz	70Hz	28.3MHz	Yes	Yes

*1 Displays a reduced image, except in Dot by Dot. In Dot by Dot, the image will be cut down to panel size then displayed.

*2 Compatible when HDMI MODES is MODE1.

- Depending on the connected computer, images may not be displayed properly even if the compatible signal described above is input.

Specifications

■Compatible signal timing (AV)

Screen resolution	Frequency	HDMI
4096 × 2160p	24Hz	Yes
	25Hz	Yes
	30Hz	Yes
	50Hz	Yes
	59.94Hz	Yes
	60Hz	Yes
3840 × 2160p	24Hz	Yes
	25Hz	Yes
	30Hz	Yes
	50Hz	Yes
	59.94Hz	Yes
	60Hz	Yes
1920 × 1080p	24Hz	Yes
	50Hz	Yes
	59.94Hz	Yes
	60Hz	Yes
1920 × 1080i	50Hz	Yes
	59.94Hz	Yes
	60Hz	Yes
1280 × 720p	50Hz	Yes
	59.94Hz	Yes
	60Hz	Yes
720 × 576p	50Hz	Yes
720 × 480p	59.94Hz	Yes
	60Hz	Yes
640 × 480p(VGA)	59.94Hz	Yes
	60Hz	Yes
720(1440) × 576i	50Hz	Yes
720(1440) × 480i	59.94Hz	Yes
	60Hz	Yes

Mounting Precautions (For SHARP dealers and service engineers)

- When installing, removing or moving the monitor, ensure that this is carried out by at least 2 people.
- Be sure to use a wall-mount bracket designed or designated for mounting the monitor.
- This monitor is designed to be installed on a concrete wall or pillar. Reinforced work might be necessary for some materials such as plaster / thin plastic board / wood before starting installation.
- This monitor and bracket must be installed on a wall which can endure at least 4 times or more the weight of the monitor. Install by the most suitable method for the material and the structure.
- To attach a VESA-compliant mounting bracket, use M6 screws that are 3/8 inch (10 mm) to 1/2 inch (12 mm) longer than the thickness of the mounting bracket.

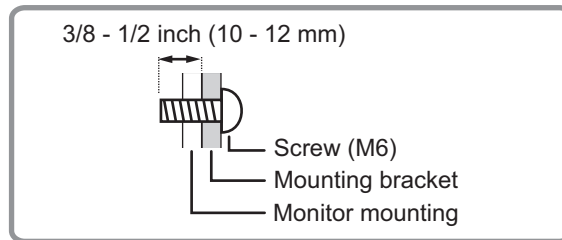

- Do not use an impact driver.
- When moving the monitor, be sure to hold it around the periphery. Do not grasp the screen. This may cause product damage, failure, or injury.
- After mounting, please carefully ensure the monitor is secure, and not able to come loose from the wall or mount.
- Do not use any screw holes other than those for mounting brackets, located on the rear of the monitor, for installation.
- When using the monitor laying flat on a surface (when the monitor is tilted 20 degrees or more upward or downward from the perpendicular in relation to a level surface), consult an authorized SHARP dealer because there are some specific mounting conditions.

SHARP
SHARP CORPORATION