

Lexmark™ T65x Quick Reference

Loading paper and specialty media

Loading the 250-sheet or 550-sheet tray

- 1 Pull the tray out.

Note: Do not remove trays while a job prints or while **Busy** appears on the display. Doing so may cause a jam.

- 2 Squeeze the width guide tab inward as shown, and move the width guide to the correct position for the paper size being loaded.

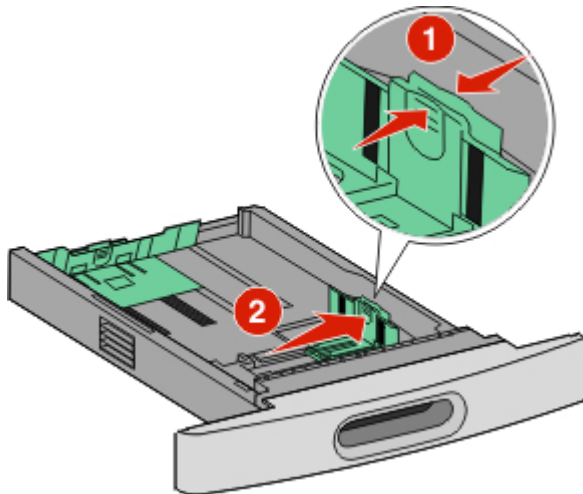

- 3 Unlock the length guide, squeeze the length guide tab inward as shown, and slide the guide to the correct position for the paper size being loaded.

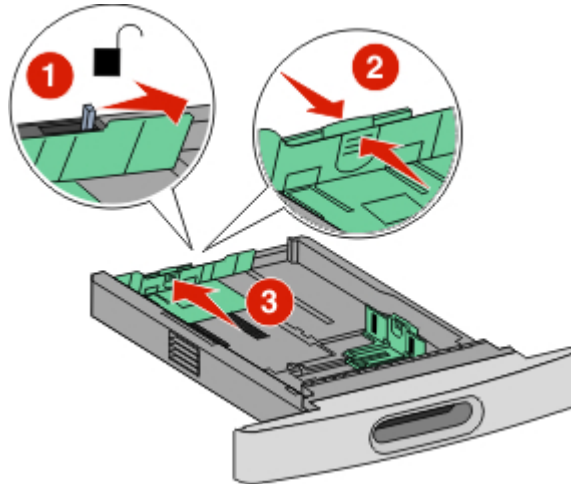

Notes:

- Use the size indicators on the bottom of the tray to help position the guides.
- For standard paper sizes, lock the length guide.

- 4 Flex the sheets back and forth to loosen them, and then fan them. Do not fold or crease the paper. Straighten the edges on a level surface.



- 5 Load the paper.

- For single-sided printing, load the paper print side facedown with the leading edge of the paper toward the front of the tray.

Note: For print jobs using an optional StapleSmart™ II Finisher, place the leading edge of the paper toward the back of the tray.

- For two-sided or duplex printing, load the paper faceup with the leading edge of the paper toward the back of the tray.

Note: For print jobs using an optional StapleSmart II Finisher, place the leading edge of the paper toward the front of the tray.

Note: Notice the maximum fill line on the side of the tray which indicates the maximum height for loading paper. Do not overload the tray.

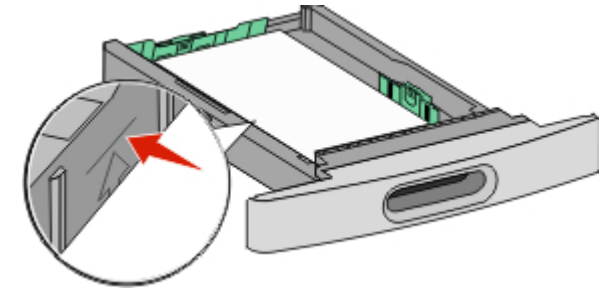

- 6 If necessary, adjust the paper guides to lightly touch the sides of the stack, and lock the length guide for the paper sizes indicated on the tray.

- 7 Insert the tray.

- 8 If a different type of paper was loaded than the type previously loaded in the tray, then change the Paper Type setting for the tray from the printer control panel.

Loading the 2000-sheet tray

- 1 Pull the tray out.
- 2 Pull up and slide the width guide to the correct position for the paper size being loaded.

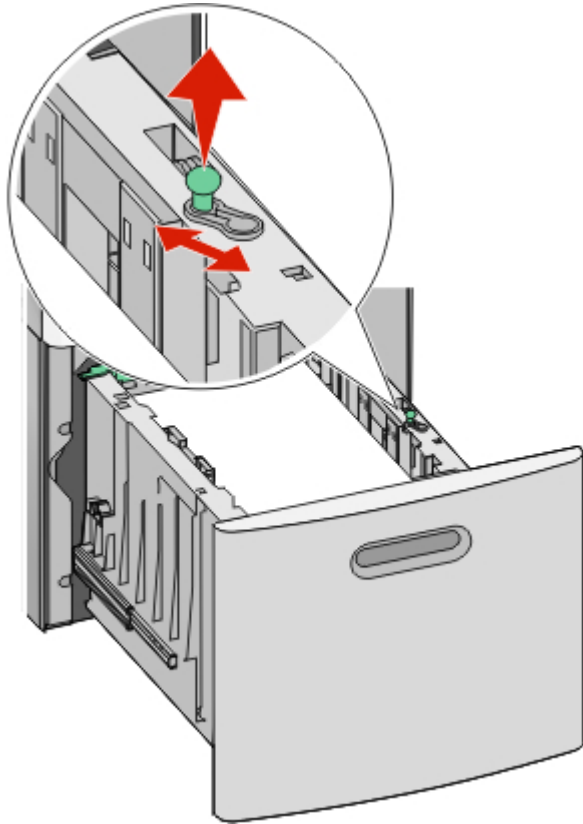

- 3 Unlock the length guide.

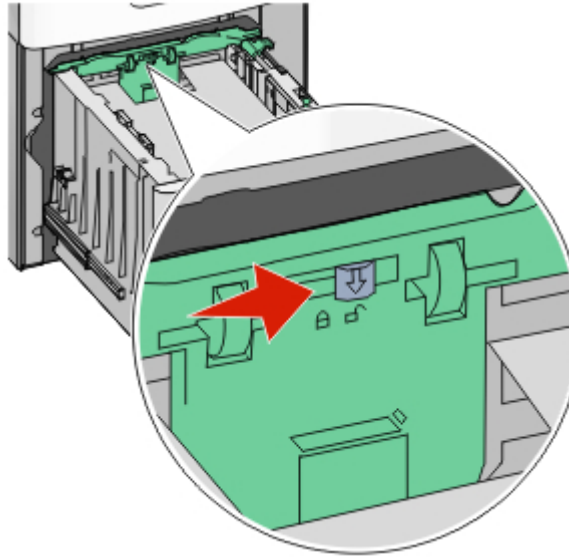

- 4 Push the length guide release latch to raise the length guide, slide the guide to the correct position for the paper size being loaded, and then lock the guide.

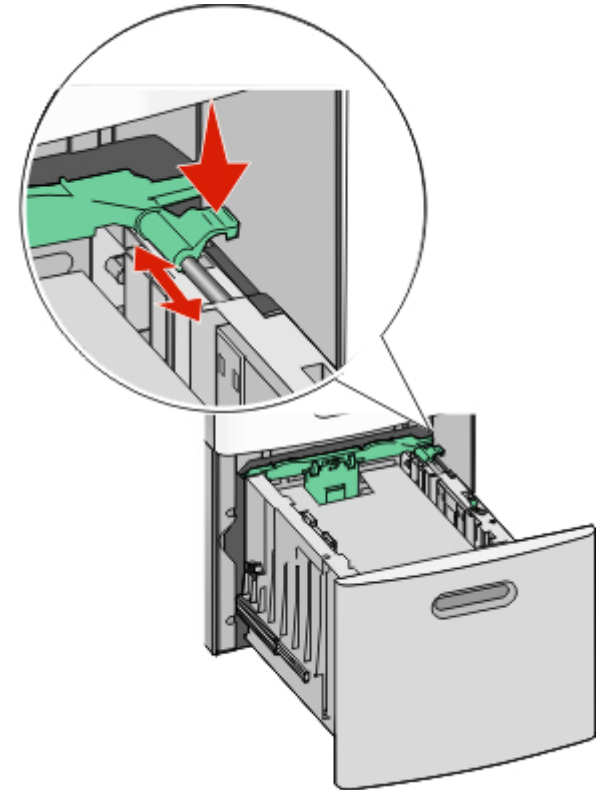

- 5 Flex the sheets back and forth to loosen them, and then fan them. Do not fold or crease the paper. Straighten the edges on a level surface.

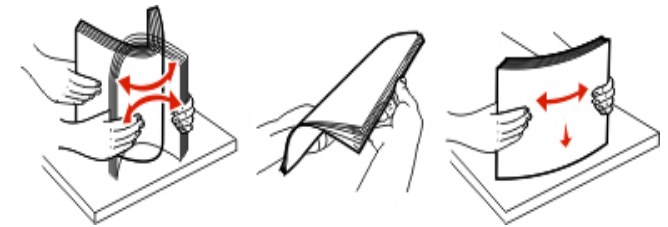

6 Load the paper stack:

- Print side facedown for single-sided printing
- Print side faceup for duplex printing

Note: Paper must be loaded differently in the trays if an optional StapleSmart II Finisher is installed. For more information, see the *User's Guide*.

Note: Notice the maximum fill line on the side of the tray which indicates the maximum height for loading paper. Do not overload the tray.

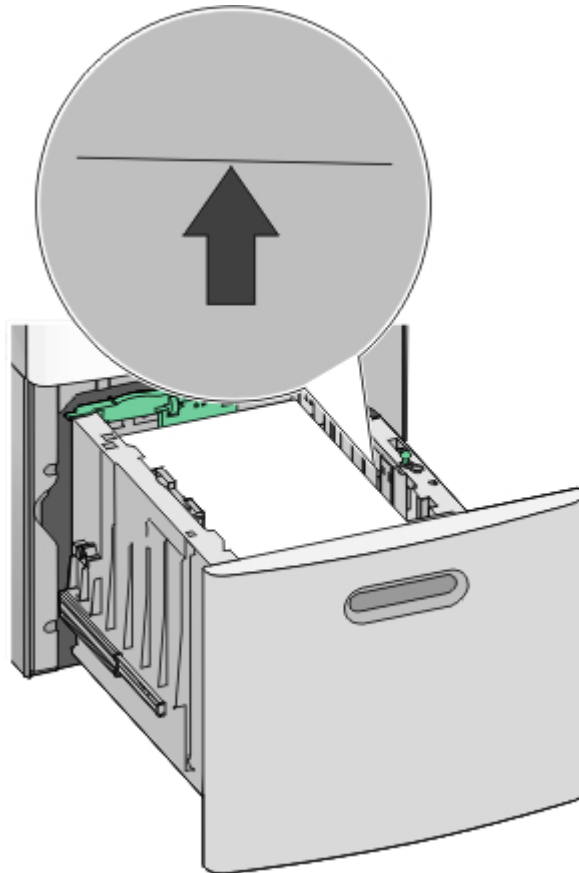

7 Insert the tray.

Loading the multipurpose feeder

1 Press the release latch, and then pull down the multipurpose feeder door.

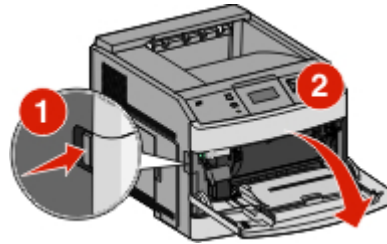

2 Pull out the extension until it is fully extended.

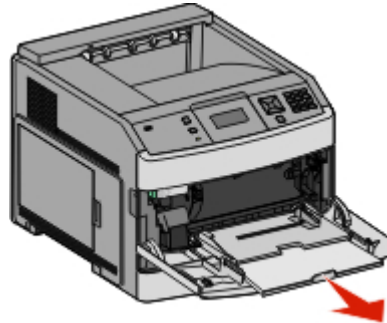

3 Squeeze and slide the width guide to the far right.

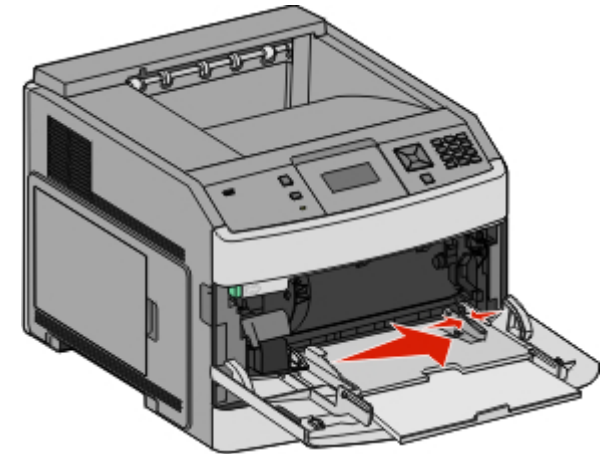

4 Flex the sheets of paper or specialty media back and forth to loosen them, and then fan them. Do not fold or crease them. Straighten the edges on a level surface.

5 Load the paper or specialty media. Slide the stack gently into the multipurpose feeder until it comes to a stop.

Notes:

- Do not exceed the maximum stack height by forcing paper under the stack height limiter.
- Do not load or close the printer while a job is printing.
- Load only one size and type of media at a time.
- Load envelopes with the flap side down and to the left as shown on the tray.









Warning—Potential Damage: Never use envelopes with stamps, clasps, snaps, windows, coated linings, or self-stick adhesives. These envelopes may severely damage the printer.

6 Adjust the width guide to lightly touch the edge of the paper stack. Make sure the paper fits loosely in the multipurpose feeder, lies flat, and is not bent or wrinkled.

7 From the printer control panel, set the Paper Size and Paper Type.

Setting the Paper Size and Paper Type

The Paper Size setting is determined by the position of the paper guides in the tray for all trays except the multipurpose feeder. The Paper Size setting for the multipurpose feeder must be set manually. The factory default Paper Type setting is Plain Paper. The Paper Type setting must be set manually for all trays that do not contain plain paper.

- 1 Make sure the printer is on and **Ready** appears.
- 2 From the printer control panel, press .
- 3 Press the arrow buttons until  **Paper Menu** appears, and then press .
- 4 Press the arrow buttons until  **Paper Size/Type** appears, and then press .
- 5 Press the arrow buttons until the correct tray appears, and then press .
- 6 Press the arrow buttons until  appears next to the correct size, and then press .
- 7 Press the arrow buttons until the correct Paper Type setting appears, and then press . **Ready** appears.

Printing

Printing a document

- 1 From the printer control panel Paper menu, set the Paper Type and Paper Size to match the loaded paper.
- 2 Send the print job:

For Windows users

- a With a document open, click **File → Print**.
- b Click **Properties, Preferences, Options, or Setup**, and then adjust the settings as needed.

Note: To print on a specific size or type of paper, adjust the paper size or type settings to match the loaded paper, or select the appropriate tray or feeder.
- c Click **OK**, and then click **Print**.

For Macintosh users

- a Customize the settings as needed in the Page Setup dialog:
 - 1 With a document open, choose **File > Page Setup**.
 - 2 Choose a paper size or create a custom size to match the loaded paper.
 - 3 Click **OK**.
- b Customize the settings as needed in the Print dialog:
 - 1 With a document open, choose **File > Print**. If necessary, click the disclosure triangle to see more options.
 - 2 From the Print dialog and pop-up menus, adjust the settings as needed.

Note: To print on a specific paper type, adjust the paper type setting to match the loaded paper, or select the appropriate tray or feeder.
 - 3 Click **Print**.

Printing confidential and other held jobs

Holding jobs in the printer

When sending a job to the printer, you can specify that you want the printer to hold the job in memory until you start the job from the printer control panel. All print jobs that can be initiated by the user at the printer are called *held jobs*.

Note: Confidential, Verify, Reserve, and Repeat print jobs may be deleted if the printer requires extra memory to process additional held jobs.

Job type	Description
Confidential	When you send a Confidential print job to the printer, you must create a PIN from the computer. The PIN must be four digits using the numbers 0–9. The job is held in printer memory until you enter the PIN from the printer control panel and choose to print or delete the job.
Verify	When you send a Verify print job, the printer prints one copy and holds the remaining copies in printer memory. Verify lets you examine the first copy to see if it is satisfactory before printing the remaining copies. Once all copies are printed, the job is automatically deleted from printer memory.
Reserve	When you send a Reserve print job, the printer does not print the job immediately. It stores the job in memory so you can print the job later. The job is held in memory until you delete it from the Held Jobs menu.
Repeat	When you send a Repeat print job, the printer prints all requested copies of the job <i>and</i> stores the job in memory so you can print additional copies later. You can print additional copies as long as the job remains stored in memory.

Other types of held jobs include:







- Profiles from various sources including Lexmark™ Document Solutions Suite (LDSS)
- Forms from a kiosk
- Bookmarks
- Jobs not printed, which are called *parked jobs*

Printing confidential and other held jobs









Note: Confidential and Verify print jobs are automatically deleted from memory after they print. Repeat and Reserve jobs continue to be held in the printer until you choose to delete them.

For Windows Users

- 1 With a document open, click **File → Print**.
- 2 Click **Properties, Preferences, Options, or Setup**.

- 3 Click **Other Options**, and then click **Print and Hold**.
- 4 Select your job type (Confidential, Repeat, Reserve, or Verify), and then assign a user name. For a confidential job, also enter a four-digit PIN.
- 5 Click **OK** or **Print**, and then go to the printer to release the job.
- 6 From the printer control panel, press the arrow buttons until  **Held jobs** appears, and then press .
- 7 Press the arrow buttons until  appears next to your user name, and then press .
- 8 Press the arrow buttons until  appears next to the job type or job name, and then press .







If you selected a job name, proceed to step 11 on page 5.

- 9 After selecting your job type, use the keypad to enter your PIN. If you enter an invalid PIN, the Invalid PIN screen appears.
 - To re-enter the PIN, make sure  **Try again** appears, and then press .
 - To cancel the PIN, press the arrow buttons until  **Cancel** appears, and then press .
- 10 Press the arrow buttons until  appears next to the job you want to print, and then press .
- 11 Press the arrow buttons until  appears next to the number of copies you want to print, and then press .









Note: Use the keypad to enter a number if necessary.

For Macintosh users

- 1 With a document open, choose **File > Print**.
If necessary, click the disclosure triangle to see more options.
- 2 From the print options or Copies & Pages pop-up menu, choose **Job Routing**.
- 3 Select your job type (Confidential, Repeat, Reserve, or Verify), and then assign a user name. For a confidential job, also enter a four-digit PIN.
- 4 Click **OK** or **Print**, and then go to the printer to release the job.

- 5 From the printer control panel, press the arrow buttons until  **Held jobs** appears, and then press .
 - 6 Press the arrow buttons until  appears next to your user name, and then press .
 - 7 Press the arrow buttons until  appears next to the job type or job name, and then press .

If you selected a job name, proceed to step 10 on page 5.

 - 8 After selecting your job type, use the keypad to enter your PIN. If you enter an invalid PIN, the Invalid PIN screen appears.
 - To re-enter the PIN, make sure  **Try again** appears, and then press .
 - To cancel the PIN, press the arrow buttons until  **Cancel** appears, and then press .
 - 9 Press the arrow buttons until  appears next to the job you want to print, and then press .
 - 10 Press the arrow buttons until  appears next to the number of copies you want to print, and then press .
- Note:** Use the keypad to enter a number if necessary.

Printing from a flash drive

A USB port is located on the printer control panel. Insert a flash drive to print supported file types. Supported file types include: .pdf, .gif, .jpeg, .jpg, .bmp, .png, .tiff, .tif, .pcx, .xps, and .dxc.

Many flash drives are tested and approved for use with the printer. For more information, visit the Lexmark Web site at www.lexmark.com.

Notes:

- High-speed flash drives must support the full-speed USB standard. Flash drives supporting only USB low-speed capabilities are not supported.
- Flash drives must support the FAT (*File Allocation Tables*) system. Flash drives formatted with NTFS (*New Technology File System*) or any other file system are not supported.



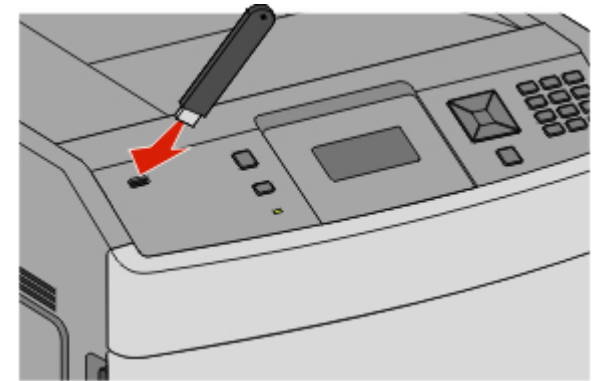

- Before printing an encrypted .pdf file, enter the file password from the printer control panel.
- You cannot print files for which you do not have printing permissions.

To print from a flash drive:

- 1 Make sure the printer is on and **Ready** appears.
- 2 Insert a flash drive into the front USB port.









Notes:

- If you insert the flash drive when the printer requires attention, such as when a jam has occurred, then the printer ignores it.
 - If you insert the flash drive while the printer is printing other jobs, then **Printer Busy** appears. After the other jobs are processed, you may need to view the held jobs list to print documents from the flash drive.
- 3 Press the down arrow button until  appears next to the document you want to print, and then press .
- Note:** Folders found on the flash drive appear as folders. File names are appended by the extension type (for example, .jpg).
- 4 Press  to print one copy, or enter the number of copies using the keypad, and then press  to initiate the print job.
- Note:** Do not remove the flash drive from the printer until the document has finished printing.
- If you leave the flash drive in the printer after leaving the initial USB menu screen, you can still print .pdf files from the flash drive as held jobs.

Canceling a print job from the printer control panel

If the job is formatting or already printing, and **Cancel a job** appears on the first line of the display:

- 1 Press the arrow buttons until  **Cancel** appears.
A list of jobs appears.
- 2 Press the arrow buttons until  appears next to the job you want to cancel, and then press .

Note: Once a print job is sent, to easily cancel a job, press . The **Stopped** screen appears. Press the arrow buttons until  **Cancel a job** appears, and then press .

Maintaining the printer

Cleaning the exterior of the printer

- 1 Make sure that the printer is turned off and unplugged from the wall outlet.



CAUTION—SHOCK HAZARD: To avoid the risk of electric shock when cleaning the exterior of the printer, unplug the power cord from the wall outlet and disconnect all cables to the printer before proceeding.

- 2 Remove paper from the standard exit bin.
- 3 Dampen a clean, lint-free cloth with water.

Warning—Potential Damage: Do not use household cleaners or detergents, as they may damage the finish of the printer.

- 4 Wipe only the outside of the printer, making sure to include the standard exit bin.

Warning—Potential Damage: Using a damp cloth to clean the interior may cause damage to your printer.

- 5 Make sure the paper support and standard exit bin are dry before beginning a new print job.