

General Installation Process

The installation instructions in this section are for general components of Intel® Server System P4000IP and Intel® Workstation System P4000CR family, but the illustrations are based on the Intel® Server System P4216IP4LHJC.

Minimum Hardware Requirements

To avoid integration difficulties and possible damage to your system, make sure you have components from each category below.

- Processor
- Heat Sink
- Memory
- Hard Disk Drives
- Power
- Air Duct

1 Preparing the System

Observe normal ESD (Electrostatic Discharge) procedures.

Place your Intel® Server System on a flat anti-static surface to perform the following integration procedures. Observe ESD procedures before reaching inside to make server board connections or install components.



2 Remove the Side Cover

- A Remove the screws.
- B Slide the side cover back and lift the cover outward to remove it.

Note:
A non-skid surface or a stop behind the chassis may be needed to prevent the chassis from sliding on your work surface.

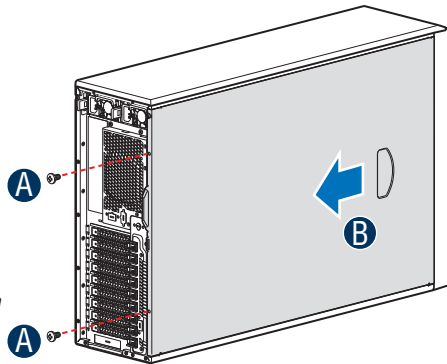

3 Remove the Air Duct

- A Remove the air duct.

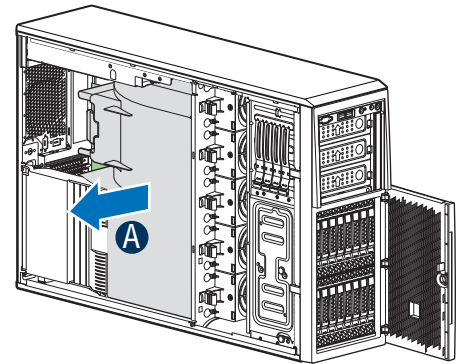

4 Install the Processor(s)

A. Open the Socket Lever

- A Push down the lever handle on the open 1st side and away from the socket to release it.
- B Repeat the steps to release the lever on the other side.

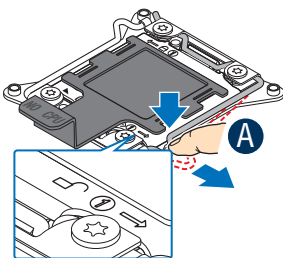
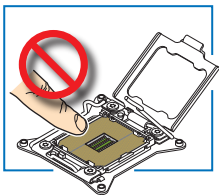

NOTE: Release the levers in the order as shown.

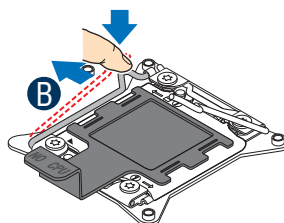

B. Open the Load Plate

- A Press the locking lever slightly to raise the load plate.
- B Open the load plate all the way.

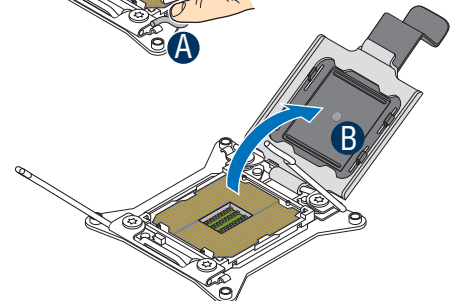
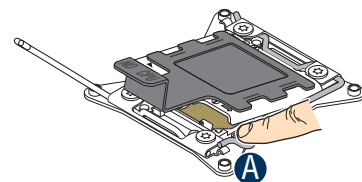

General Installation Process

Install the Processor(s) ... *continued*

C. Install the Processor



CAUTION: The underside of the processor has components that may damage the socket pins if installed improperly.

Processor must align correctly with the socket opening before installation.
DO NOT DROP processor into socket!

Components

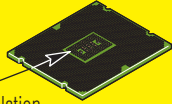

Take the processor out of the box and remove the protective shipping cover.

Orient the processor with the socket so that the processor cutouts match the four orientation posts on the socket.

Note location of gold key at corner of processor.



CAUTION: When unpacking a processor, hold by the edges only to avoid touching the gold contact pins.



Save the protective cover.

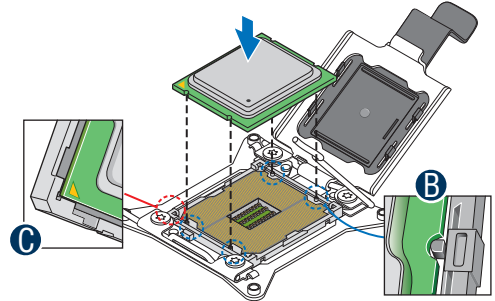

Install the Processor(s) ... *continued*

D. Remove the Cover

Press the cover to remove it.

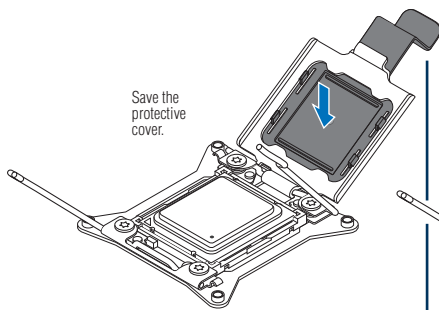

E. Close the Load Plate

Carefully lower the load plate over the processor.

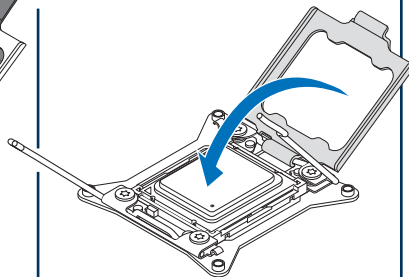

F. Latch the Locking Lever

- A** Push down on the locking lever on the close 1st side.
- B** Slide the tip of the lever under the notch in the load plate. *Make sure the load plate tab engages under the socket lever when fully closed.*
- C** Repeat the steps to latch the locking lever on the other side.

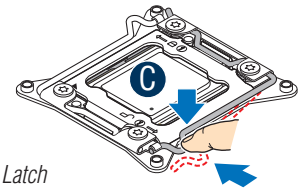
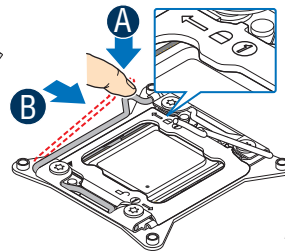

NOTE: Latch the levers in the order as shown.

5

Install Heat Sink(s)

- A** Get heat sink from the shipping position.
- B** Remove the protective film on the TIM if present.
- C** Align heat sink fins to the front and back of the chassis for correct airflow. *Airflow goes from front-to-back of chassis.*

The heat sink has four captive fasteners and should be tightened using the following procedure:

- D** Using a #2 Phillips* screwdriver, finger-tighten each fastener diagonally, according to the numbers shown.
- E** Securely re-tighten each fastener again in the same order as performed in Step D.



CAUTION: The heat sink has thermal interface material (TIM) on the underside of it. Use caution so that you do not damage the thermal interface material. *Use gloves to avoid sharp edges.*

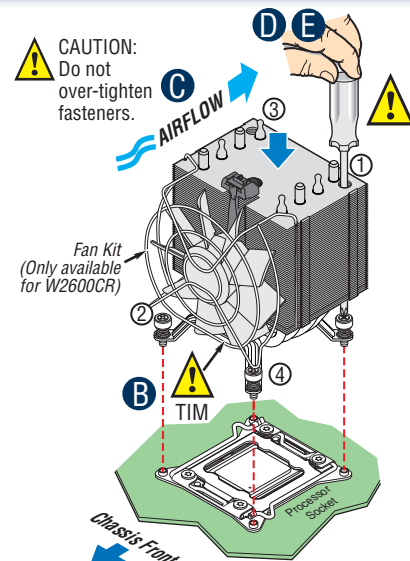

General Installation Process

6

Install DIMM Memory Modules

DDR3 DIMM Memory Identification:



CAUTION: Observe normal ESD (ElectroStatic Discharge) procedures to avoid possible damage to system components.



This server board supports up to 16 DDR3 800/1066/1333/1600 ECC UDIMM/RDIMM/LRDIMM.

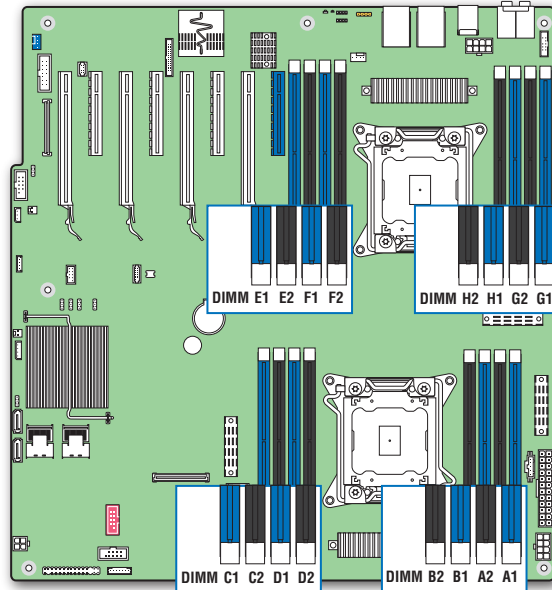
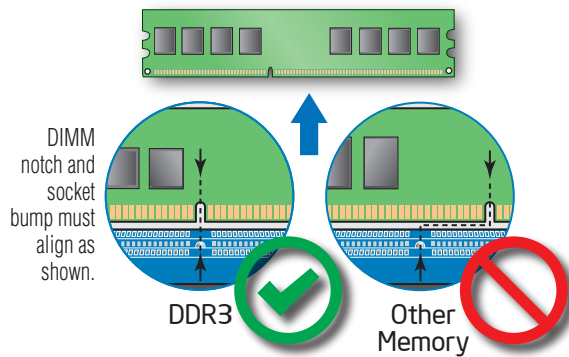

Memory Type: Minimum of one 1 GB, DDR3 800/1066/1333/1600 MHz ECC UDIMM/RDIMM/LRDIMM.

Memory sizing and configuration is supported only for qualified DIMMs approved by Intel. For a list of supported memory, see the tested memory list at <http://serverconfigurator.intel.com/default.aspx>

Install DIMM Memory Modules ... Continued

To Install DIMMs:

- A** Open both DIMM socket levers.
- B** Note location of alignment notch.
- C** Insert DIMM making sure the connector edge of the DIMM aligns correctly with the slot.
- D** Push down firmly on the DIMM until it snaps into place and both levers close.
- E** IMPORTANT! Visually check that each latch is fully closed and correctly engaged with each DIMM edge slot.



CAUTION: Avoid touching contacts when handling or installing DIMMs.

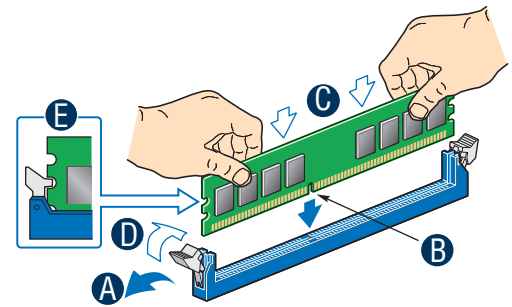

7

Install Tool-less CD-ROM or DVD-ROM Drive

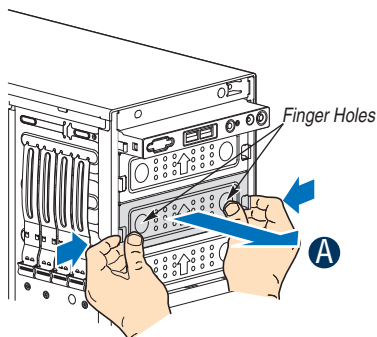

A Press the release latch and use the finger holes to Pull out the EMI shield.

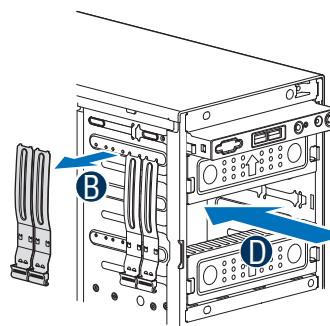

B Get the slides from the chassis side.

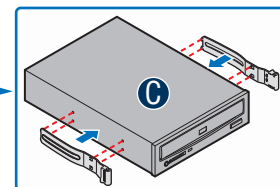

C Attach slides to the DVD or CD-ROM drive by pressing the slides firmly into the side dimples on the DVD or CD-ROM drive.

D Insert the drive/slide assembly into the device bay until the slides lock into place.

General Installation Process

8

Install Hard Drive

2.5" Hot-Swap Hard Drive Carrier (For system with 2.5" hot-swap hard drive bay only)

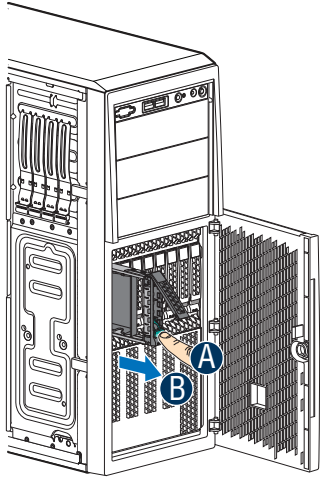

- A** Open the Hot-swap door and remove the drive carrier by pressing the **green** button and opening the lever.
- B** Slide the carrier out.

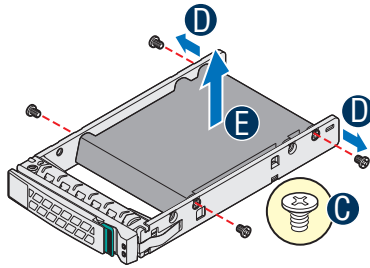

- C** Remove the four screws securing the plastic retention device to the 2.5" HDD carrier.
- D** Disengage the plastic retention device from the HDD carrier slides by pulling the slides.
- E** Remove the plastic retention device from the 2.5" HDD carrier.

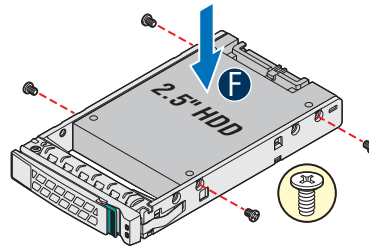

- F** Install the hard disk drive using the four screws as shown. Make sure the connector end of the drive matches the backplane connector.



CAUTION: If you don't install all drives, empty drive bays must be occupied by carriers with plastic drive blank provided to maintain proper system cooling.

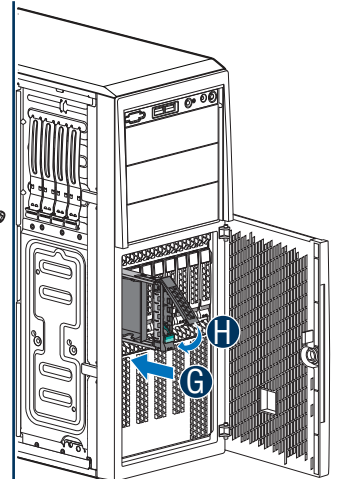

- G** With the lever open, insert the hard disk drive assembly into the cage opening and push until the locking lever engaged.
- H** Push in the lever to lock it into place, then close the door.

Install Hard Drive ... Continued

3.5" Hot-Swap Hard Drive Carrier (For system with 3.5" hot-swap hard drive bay only)

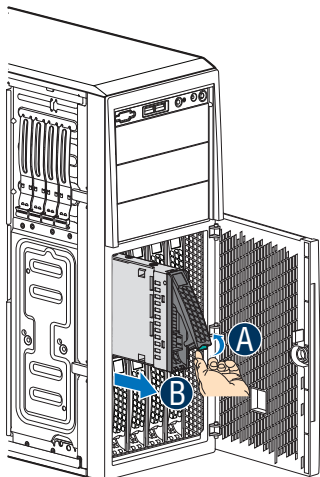

- A** Open the Hot-swap door and remove the drive carrier by pressing the **green** button and opening the lever.
- B** Slide the carrier out.

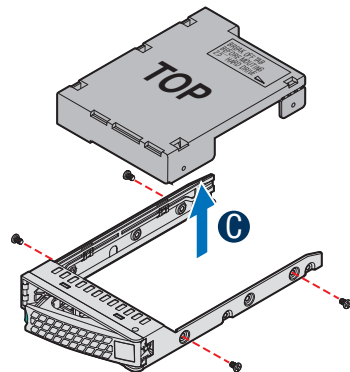

- C** Remove the four screws securing the HDD interface bracket and remove the HDD interface bracket.

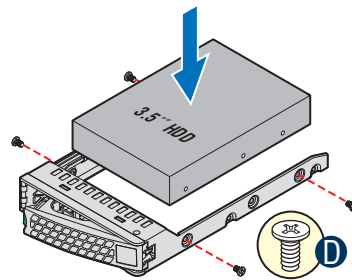

- D** Install the hard disk drive using the same four screws as shown. Make sure the connector end of the drive matches the backplane connector.



CAUTION: If you don't install all drives, empty drive bays must be occupied by carriers with plastic drive blank provided to maintain proper system cooling.

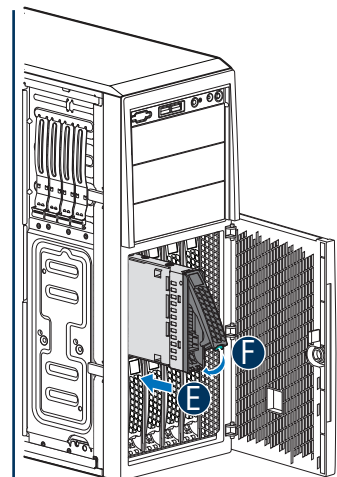

- E** With the lever open, insert the hard disk drive assembly into the cage opening and push until the locking lever engaged.
- F** Push in the lever to lock it into place, then close the door.

General Installation Process

9

Install PCI Card Assembly

- A** Remove the PCI slot shield by pushing the shield out from inside the chassis.
- B** Install the optional PCI-e card fixture with screws. The card fixture helps to hold heavy PCI-e cards (that is GPGPU card). The card fixture is ordered separately.

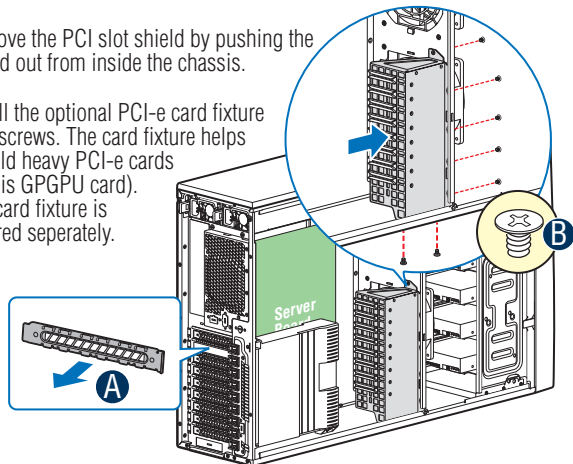

- C** Rotate the PCI retainer all the way to open.

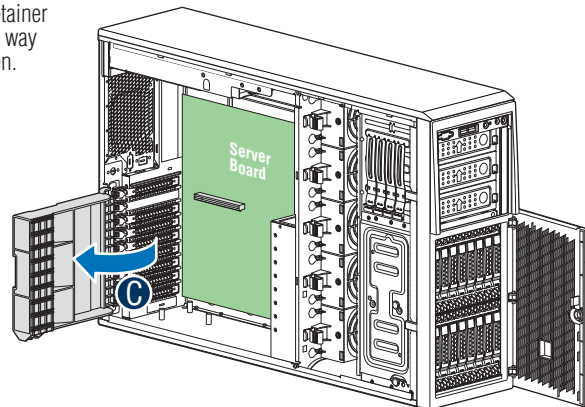

Install PCI Card Assembly ... Continued

- D** From inside of chassis, press open the back panel PCI add-in board retention device.

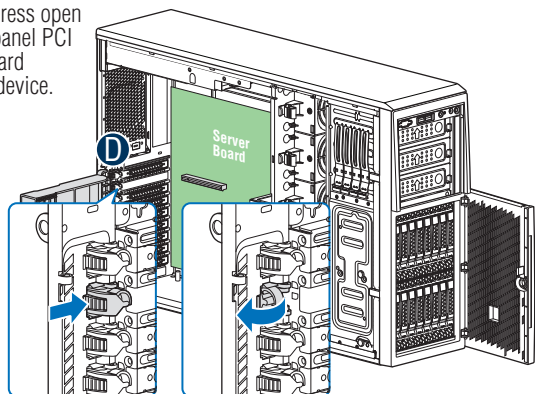

- E** While holding the PCI add-in board by its top edge or upper corners, firmly press the add-in board into the expansion slot.

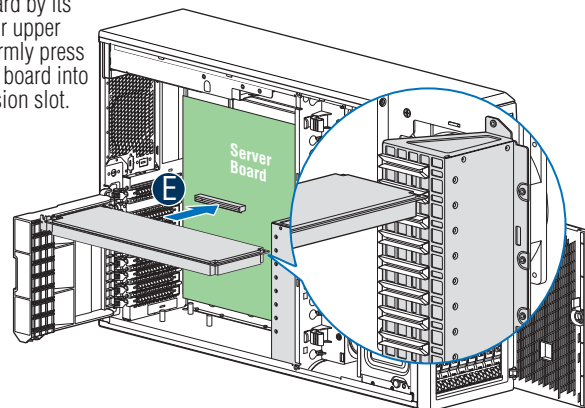

Install PCI Card Assembly ... Continued

- F** Close the PCI add-in board retention device.

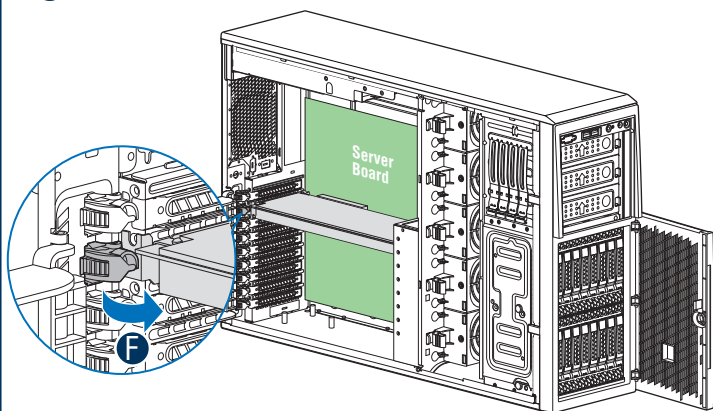

- G** Rotate the PCI card retainer until the PCI card retainer is secured by the chassis. *Make sure the PCI card is secured into the slot under the PCI Card Retainer.*

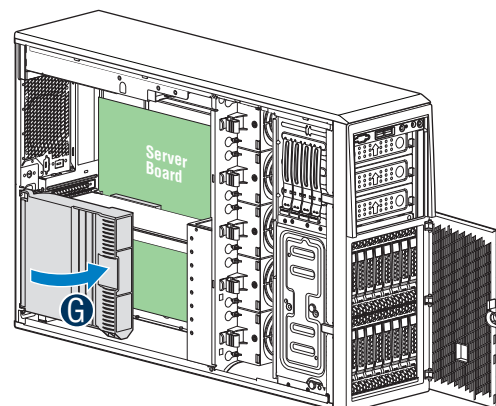

General Installation Process

10

Install Intel® Remote Management Module 4 NIC (optional)

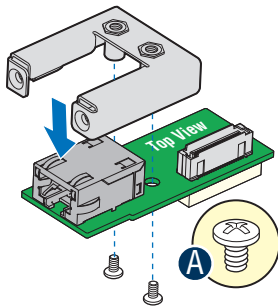

- A** Attach the metal fastening bracket to Intel® Dedicated Server Management NIC module and secure the bracket with two screws.
- B** Remove the alternate RMM4 knock out by pressing the knock out from inside the chassis.



CAUTION: Carefully remove the knock out with screwdriver, directly removing it with finger has potential risk.

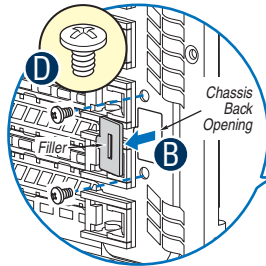

- C** Connect the cable to the cable connector on the Intel® Dedicated Server Management NIC module.
- D** Mount the NIC module to the rear panel of the chassis and secure the bracket with two screws.
- E** Connect the cable to the RMM4 NIC connector to the RMM4 NIC connector on your server board.



CAUTION: Care should be used when attaching or removing this cable. Mishandling the cable could cause damage.

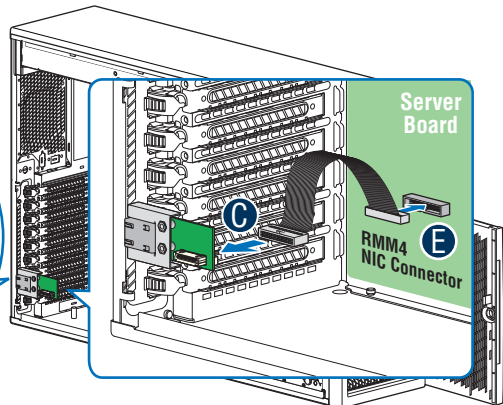

11

Install RMM4 EMI Cover (optional)

- A** Install the RMM4 EMI cover with thumb screws.

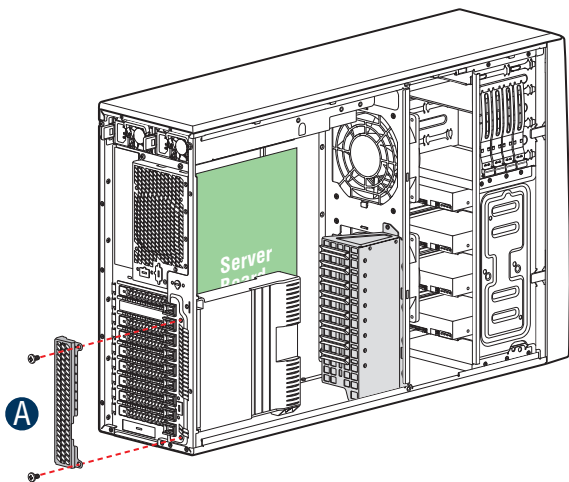

12

Install Alternate Serial Port (optional)

- A** Remove the alternate serial port knockout by pressing the knockout from inside the chassis.
- B** Mount the serial port on the rear panel of the chassis.
- C** Secure the port with two screws.
- D** Connect the cable to the Serial B Connector on your server board.



CAUTION: Carefully remove the knock out with screwdriver, directly removing it with finger has potential risk.



CAUTION: Care should be used when attaching or removing this cable. Mishandling the cable could cause damage.

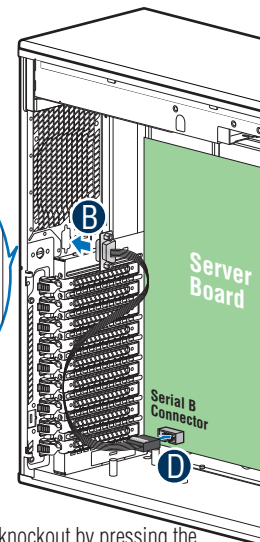
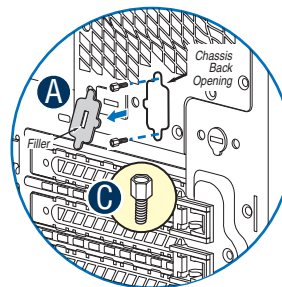

General Installation Process

13

Install Intel® RAID Smart Battery (optional)

Align the tabs on the plastic battery holder with the mounting holes in the chassis and slide the plastic battery holder toward the front of the chassis until the tabs engage with the mounting holes.

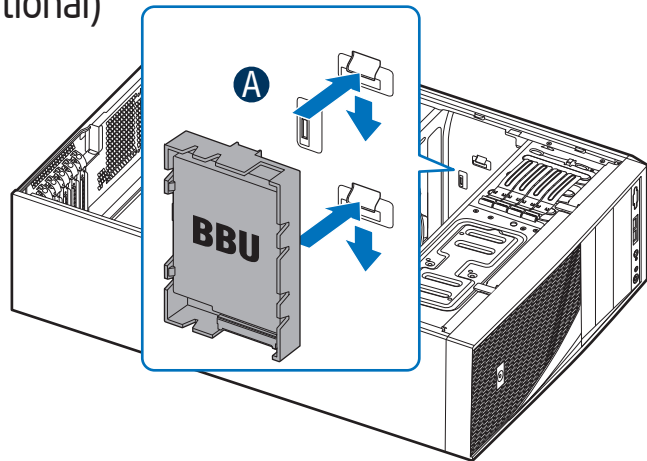

14

Install Second Power Supply Module (optional)

Note: Applies only to the chassis with hot-swap power supply configuration.

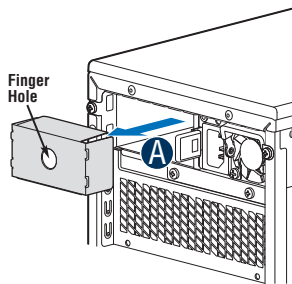

A Use the 'finger hole' to remove the filler panel.

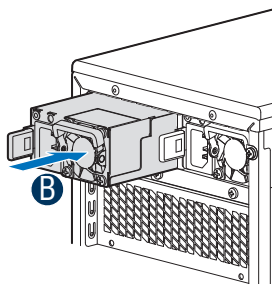

B Insert the power supply module into the power supply cage and push all the way until it clicks into place.

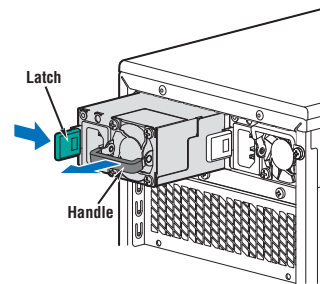

To remove a power supply module, push the green latch in the direction shown while pulling out of the system by the handle.

15

Rack Mount Configuration (optional)

- If you intend to configure your server as a pedestal system, disregard this step.
- If you intend to configure your server as a rack mount system, go to the instructions that came with your Rack Mount Kit to complete your server assembly.

16

Install Feet (pedestal only)

Note: This step applies to your chassis if configured as a pedestal system. If you plan to configure your chassis as a rack-mount system, disregard this step.

- A** Insert rubber foot into chassis hole.
- B** Secure foot by inserting pin through the rubber foot.

Note: Repeat above steps until all four feet are installed.

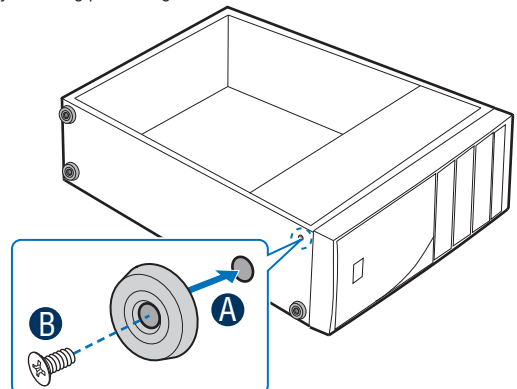

General Installation Process

17

Install Air Duct

Note: Please order the air duct that is compatible with your server board and chassis.

- A Align the air duct and chassis rail.
- B Install the air duct. Ensure that alignment holes and tabs match up.

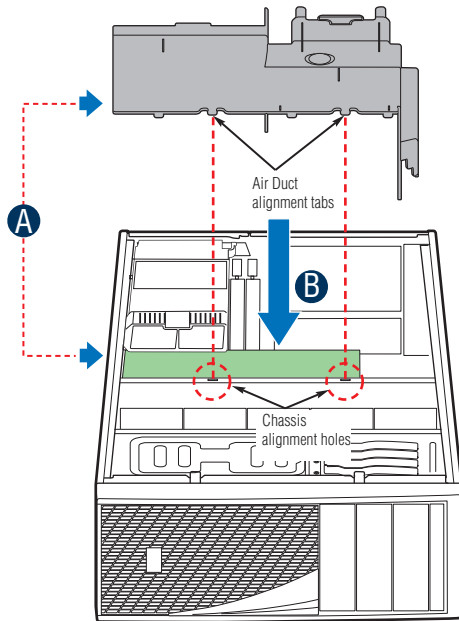

18

Install Side Cover

- A Slide the chassis cover on the chassis.
- B Secure the chassis cover with the screws.

CAUTION: This chassis must be operated with the **SIDE COVERS** installed to ensure proper cooling.

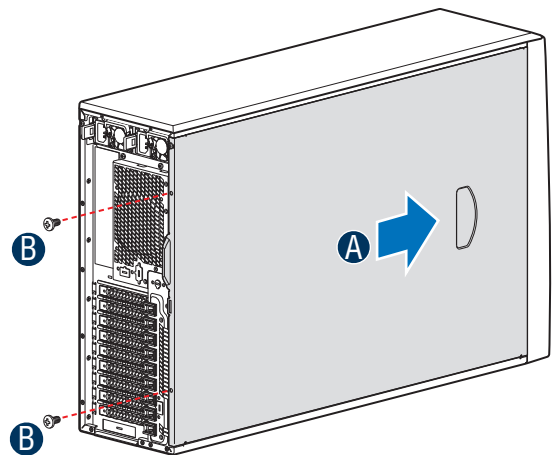

19

Finishing Up

1. See your **Intel® Server Board Quick Start User's Guide** to connect your keyboard, mouse, video, and other I/O cables.
2. Connect the AC power cable last.

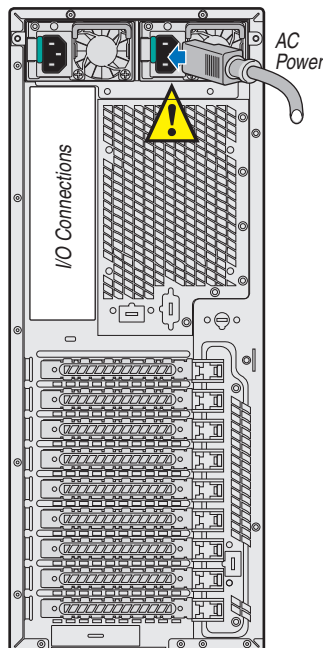

CAUTION: power supply requires a 16-gauge power cord.

20

Install Software

- BIOS, Drivers, and Operating System Install

A. Confirm BIOS Version: Look on the Server/System Management screen in the BIOS Setup Utility to determine the installed BIOS version. Compare this to the versions at: <http://www.intel.com/support>. If new versions are available, update the BIOS on your server. See the User Guide on the Intel® Server Deployment and Management DVD for update instructions.

B. Configure your RAID Controller: Use the instructions provided with the RAID controller.

C. Install your Operating System: Use the instructions provided with the RAID controller and with the operating system.

D. Install Operating System Drivers: With the operating system running, insert the Intel® Server Deployment and Management DVD. If using a Microsoft® Windows® operating system, the Express Installer will autorun and allow you to select the appropriate drivers to install. On other operating systems, browse the DVD folders to locate and install the driver files.

HDD Cage Cable Connection

Note: Refer to the documentation that came with your server board and/or RAID controller card for instructions on connecting backplane cables to your server board or RAID controller card.

8 x 2.5" HDD Cage

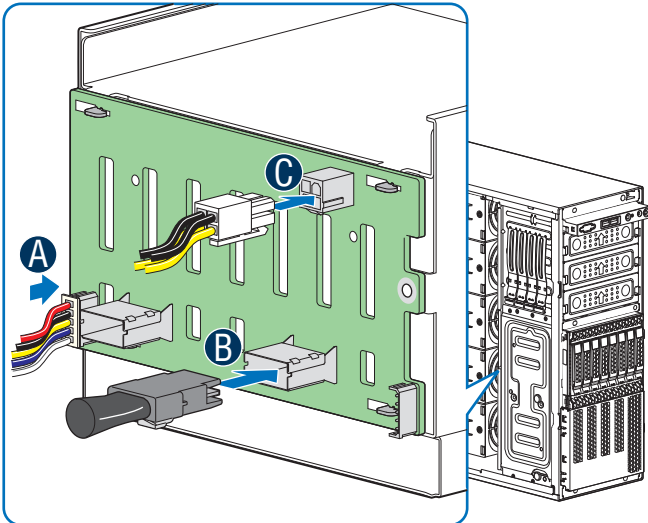

- A** Connect the I²C cable to I²C_IN connector on bottom 8x2.5" backplane.
- B** Connect Mini SAS data cables.
- C** Connect power cables* (1 x 4 to 2 x 2 Power adapter cable is needed).

16 x 2.5" HDD Cage

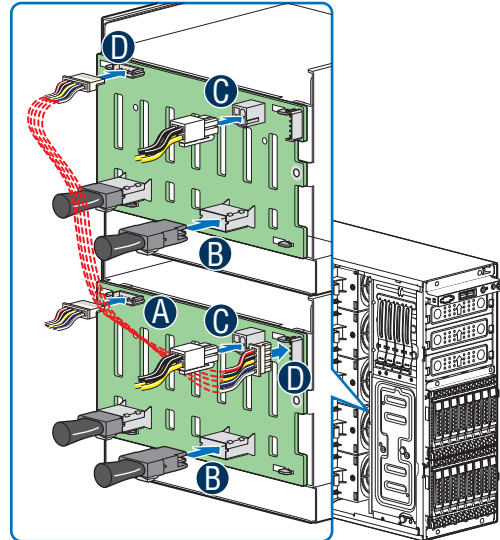

- A** Connect the I²C cable to I²C_IN connector on bottom 8x2.5" backplane.
- B** Connect Mini SAS data cables.
- C** Connect power cables* (1 x 4 to 2 x 2 Power adapter cable is needed).
- D** Connect I²C_OUT connector on bottom 8x2.5" backplane to I²C_IN connector on top 8x2.5" backplane for backplane cascade.

24 x 2.5" HDD Cage

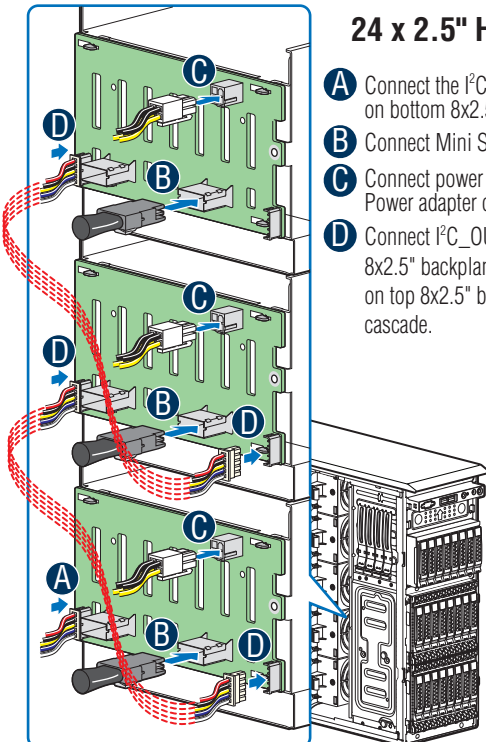

- A** Connect the I²C cable to I²C_IN connector on bottom 8x2.5" backplane.
- B** Connect Mini SAS data cables.
- C** Connect power cables* (1 x 4 to 2 x 2 Power adapter cable is needed).
- D** Connect I²C_OUT connector on bottom 8x2.5" backplane to I²C_IN connector on top 8x2.5" backplane for backplane cascade.

8 x 3.5" HDD Cage

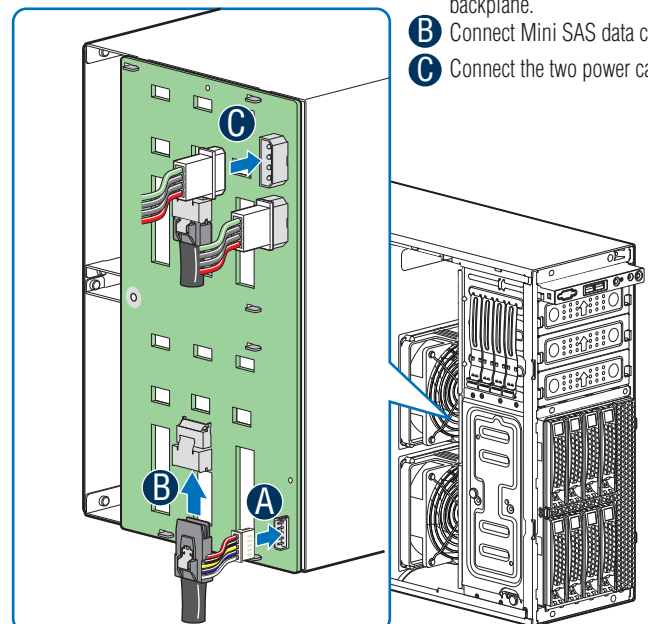

- A** Connect the I²C cable to I²C_IN connector on bottom 8x2.5" backplane.
- B** Connect Mini SAS data cables.
- C** Connect the two power cables.

Reference

Front Panel Controls and Indicators

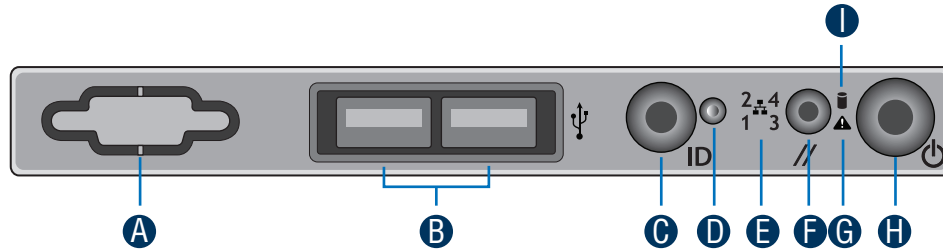

- A** Reservation(Optional VGA/Serial Port)
- B** USB Connectors
- C** ID Button with ID LED Integrated
- D** NMI Button
- E** NIC LED
- F** System Reset Button
- G** System Status LED
- H** System Power Button with Power LED
- I** HDD Activity LED

Cable Routing Diagram

Figure 1

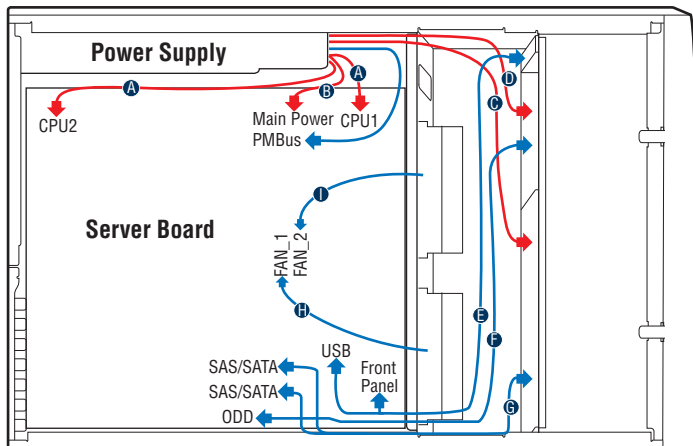
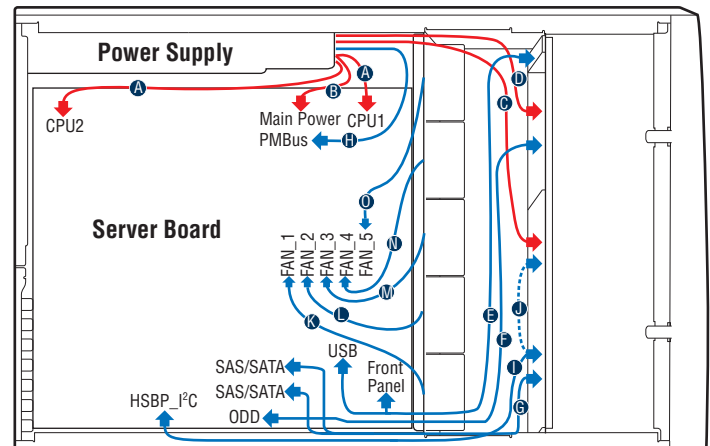

Figure 2



Description

A.	CPU1/CPU2 Power Cable
B.	Server Board Main Power Cable
C.	Fixed HDD Power Cable
D.	ODD Power Cable
E.	Front Panel Cable, USB Cable
F.	ODD Data Cable (Connect To White SATA 6G Connectors On Server Board)
G.	Fixed HDD Data Cable
H.	System FAN 1
I.	System FAN 2

RED indicates power cable routing

BLUE indicates data cable routing

Description

A.	CPU1/CPU2 Power Cable
B.	Server Board Main Power Cable
C.	Backplane Power Cable
D.	ODD Power Cable
E.	Front Panel Cable, USB Cable
F.	ODD Data Cable (Connect To White SATA 6G Connectors On Server Board)
G.	MiniSAS (with SGPIO) Cable
H.	PMBus Cable
I.	HSBP_I ² C Cable (From Server Board To First Backplane)
J.	HSBP_I ² C Cable (From First Backplane To Second Backplane when Second Backplane Available)
K.	System FAN 1
L.	System FAN 2
M.	System FAN 3
N.	System FAN 4
O.	System FAN 5

G49309-003

